

Product Description

The RFSA2113 is a fully monolithic analog voltage controlled attenuator (VCA) featuring exceptional linearity over a typical temperature compensated 30 dB gain control range. The RFSA2113 features a wide bandwidth up to 18 GHz. This VCA incorporates a revolutionary new circuit architecture to solve a long standing industry problem: high IP3, high attenuation range, low DC current, broad bandwidth and temperature compensated linear in dB control voltage characteristic.

The RFSA2113 attenuation level is set by a single positive control voltage with on chip DC conditioning circuitry. The slope polarity of the control voltage versus gain is selectable. The RFSA2113 draws a very low 2 mA current. This attenuator is matched to 50 Ω over its rated control range and frequency with no external matching components required.

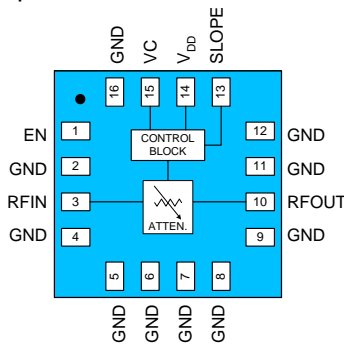

Functional Block Diagram

Typical VCA's in this performance range are based on compound semiconductor GaAs FET MMICs that require 1 to 2 negative voltages for control. This game changing product incorporates the complete solution in a small 3.2 mm x 3.2 mm multi-chip laminate module that reduces the footprint in area and simplifies the control aspects over conventional compound semiconductor attenuator approaches.

Ordering Information

Part No.	Description
RFSA2113SQ	Sample bag with 25 pieces
RFSA2113SR	7" Reel with 100 pieces
RFSA2113TR13	13" Reel with 2500 pieces
RFSA2113PCK-410	50 MHz to 18,000 MHz PCBA with 5-piece sample bag



16 Pin, 3.2 mm x 3.2 mm x 1.175 mm SMT Package

Product Features

- Patented Circuit Architecture
- Broadband 50 MHz to 18,000 MHz Frequency Range
- 30 dB Attenuation Range
- +45 dBm IIP3 Typical
- +75 dBm IIP2 Typical
- High 1 dB Compression Point +29 dBm
- Low Supply Current 2 mA Typical
- +3 to +5 V Power Supply
- Linear in dB Control Characteristic
- Internal Temperature Compensation
- Class 1C HBM ESD (≥ 1000 V)

Applications

- Point to Point Radio
- Test Instrumentation
- Microwave Radio
- High Linearity Power Control

Absolute Maximum Ratings

Parameter	Range / Value	Units
Device Voltage (V _{DD})	-0.5 to +6	V
SLOPE, VC, EN Pins	-0.5 to +6	V
RF Input Power ⁽¹⁾	+23	dBm
Storage Temperature	-55 to +150	°C
Junction Temperature (T _J)	+125	°C

Exceeding these absolute maximum ratings during operation of this device may cause permanent damage.

Notes:

1. Peak power of +29 dBm allowable when RMS power does not exceed +23 dBm.

Recommended Operating Conditions

Parameter	Min	Typ	Max	Units
Device Voltage (V _{DD})	+3.0	+5.0	+5.5	V
T _{CASE}	-40		+85	°C

Electrical specifications are measured under bias, signal and temperature conditions as specified. Specifications are not guaranteed over all recommended operating conditions.

Electrical Specifications

Parameter	Conditions ⁽¹⁾	Min	Typ	Max	Units
Operational Frequency Range		50		18000	MHz
Minimum Insertion Loss	1 GHz		2	2.8	dB
	10 GHz		3	4.5	
	18 GHz		4.5		
Gain Control Range	1 GHz	32	34		dB
	10 GHz	30	32		
	18 GHz		28		
Gain vs. Temperature	Peak to peak gain variation over temperature for fixed control voltage		1		dB
Return Loss			15		dB
Relative Phase	Insertion phase at 15 dB attenuation relative to minimum insertion loss		14		°Degrees
Input1dB Compression Point	Peak power of +29 dBm allowable when RMS power does not exceed +23 dBm. *Not Production Tested	+22	+29		dBm
Input IP3	P _{IN} + (IM3 _{dBc} / 2)	+38	+45		dBm
Input IP2	P _{IN} + IM2 _{dBc} , IM2 is F1+F2		+75		dBm
Input IH2	P _{IN} + H2 _{dBc} , H2 is second harmonic		+80		dBm
Input IH3	P _{IN} + (H3 _{dBc} / 2), H3 is third harmonic		+50		dBm
Device Current, I _{DD}			2	3.5	mA
Thermal Resistance, θ _{jc}	Junction to case			175	°C/W
Voltage Control Range, Positive Attenuation Slope	+2.5 V control voltage is lowest insertion loss, SLOPE pin logic high	0		+2.5	V
Voltage Control Range, Negative Attenuation Slope	0 V control voltage is lowest insertion loss, SLOPE pin logic low	0		+2.5	V
Voltage Control Pin Current	VC pin set to +2.5 V		1.2		µA
SLOPE and EN Pins Logic Low				+0.4	V
SLOPE and EN Pins Logic High		+1			V
Settling Time	1 dB atten. change settling within 0.1 dB of final value.			2	µsec

Notes:

1. Test conditions unless otherwise noted: V_{DD}=+5 V, Temp.=+25 °C, 50 Ω system, Freq.=10 GHz.

Measured Positive Attenuation Slope Performance

Test conditions unless otherwise noted: $V_{DD}=+3V$, $Temp=+25^{\circ}C$, PCB and connector losses de-embedded.

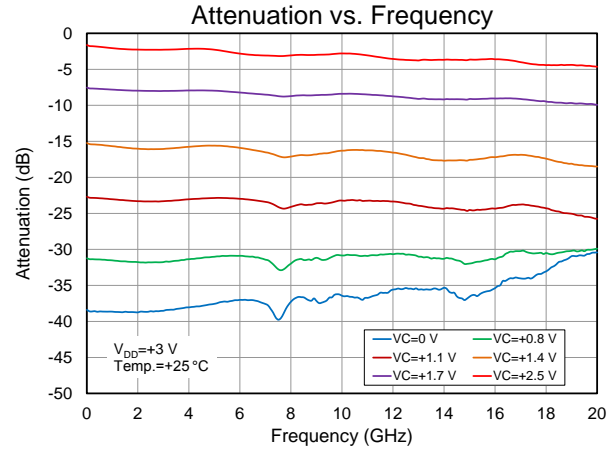
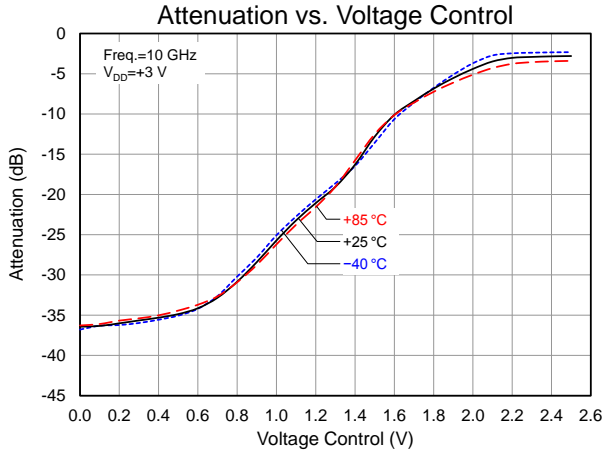

Measured Positive Attenuation Slope Performance

Test conditions unless otherwise noted: $V_{DD}=+3V$, $Temp=+25^{\circ}C$, includes PCB and connector losses.

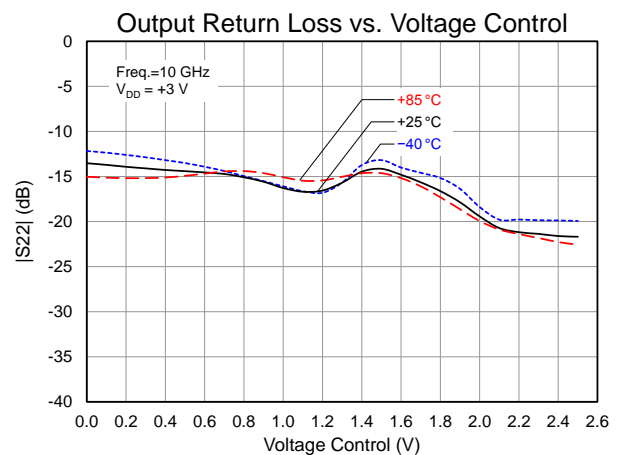
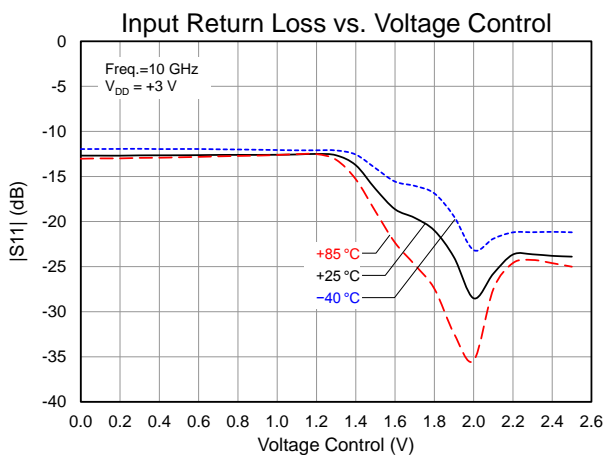
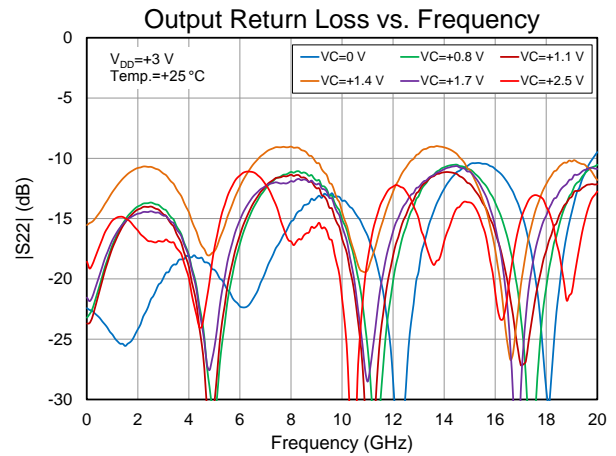
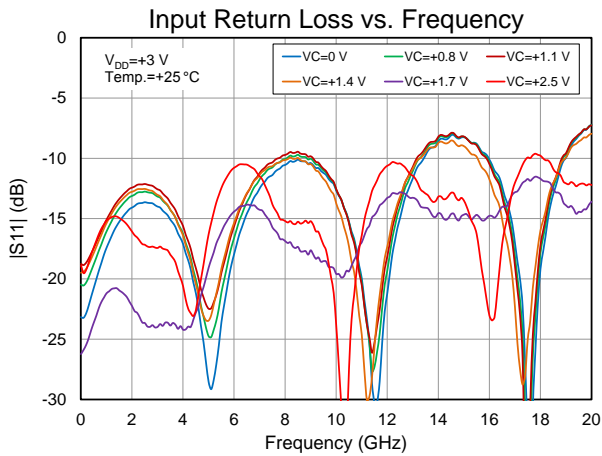

Measured Positive Attenuation Slope Performance

Test conditions unless otherwise noted: $V_{DD}=+3\text{ V}$, $\text{Temp}=+25\text{ }^{\circ}\text{C}$, includes PCB and connector losses.

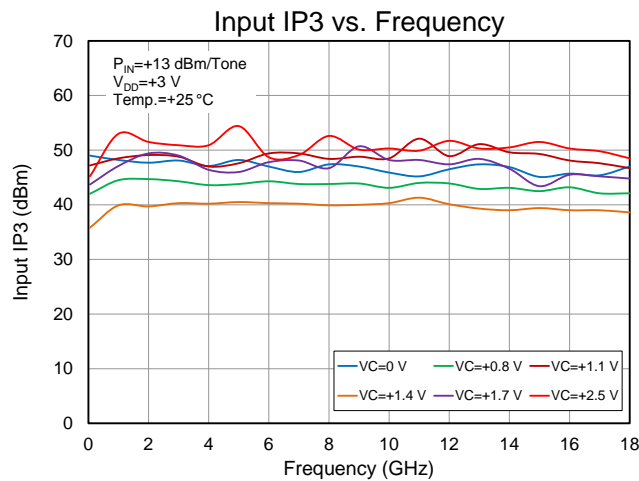
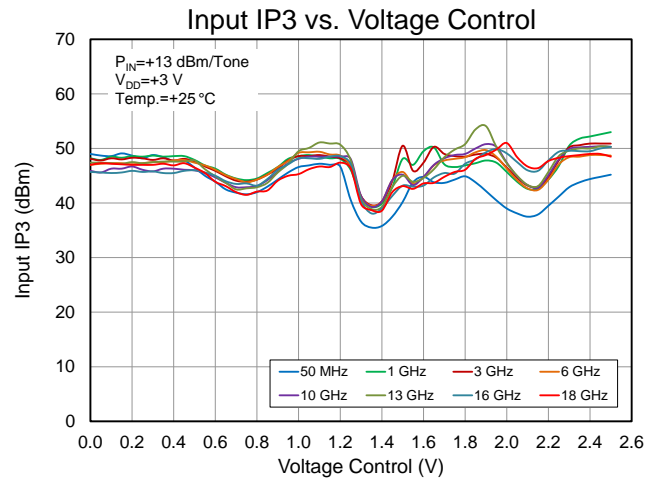
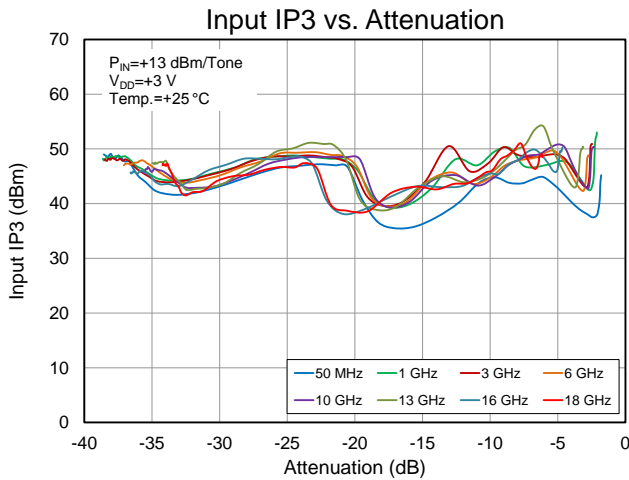
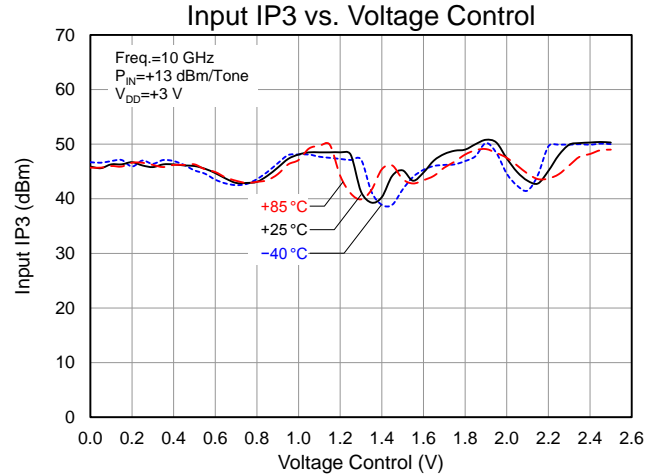
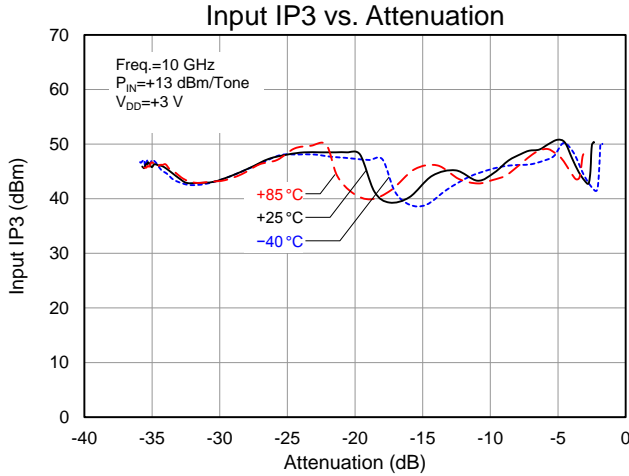

Measured Positive Attenuation Slope Performance

Test conditions unless otherwise noted: $V_{DD}=+3\text{ V}$, $\text{Temp}=+25\text{ }^{\circ}\text{C}$, includes PCB and connector losses.

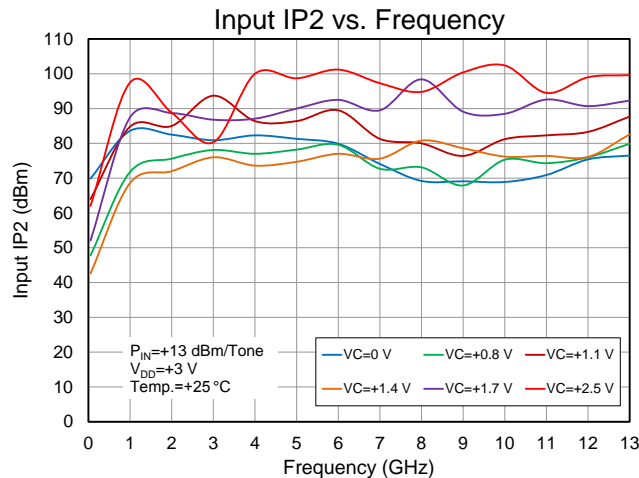
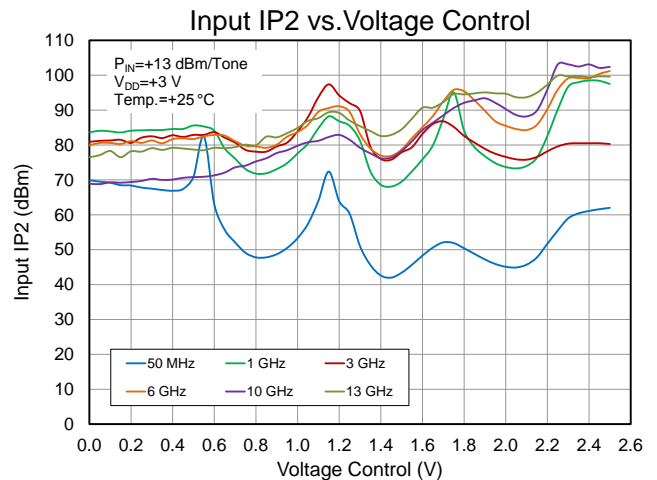
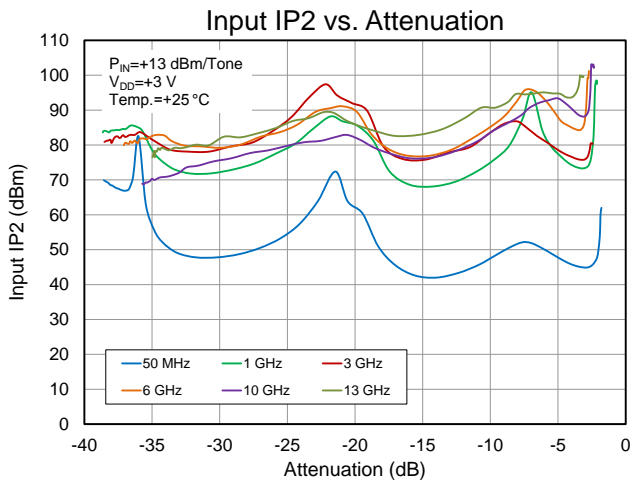
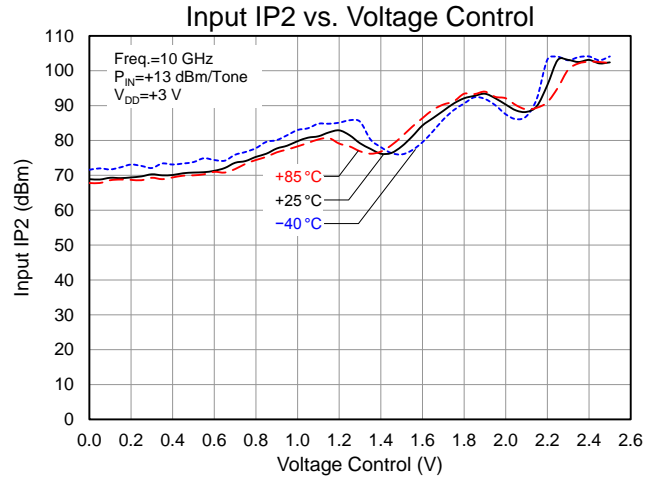
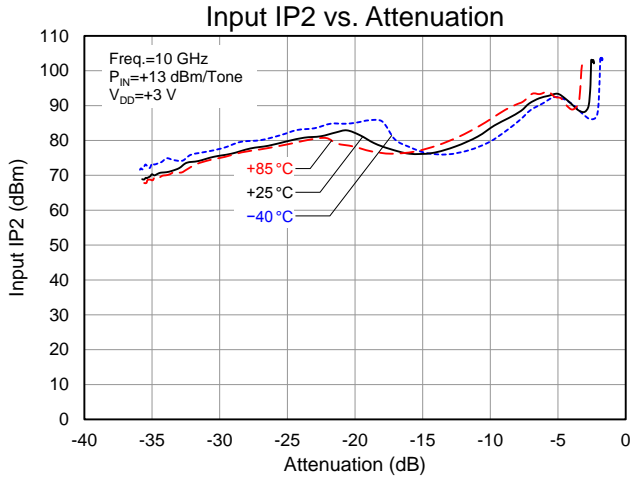

Measured Positive Attenuation Slope Performance

Test conditions unless otherwise noted: $V_{DD}=+3\text{ V}$, $\text{Temp}=+25\text{ }^{\circ}\text{C}$, includes PCB and connector losses.

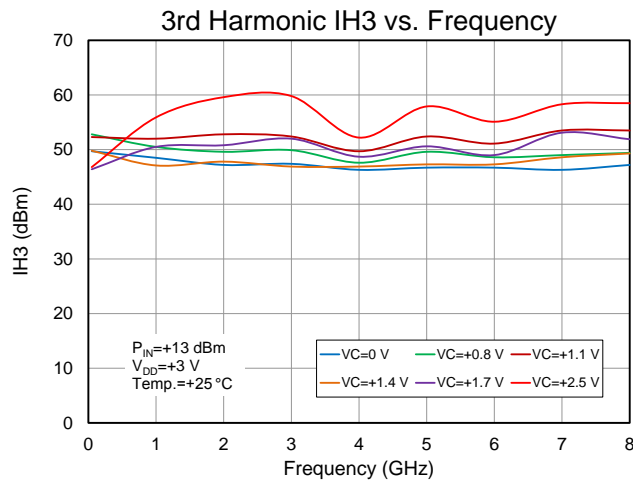
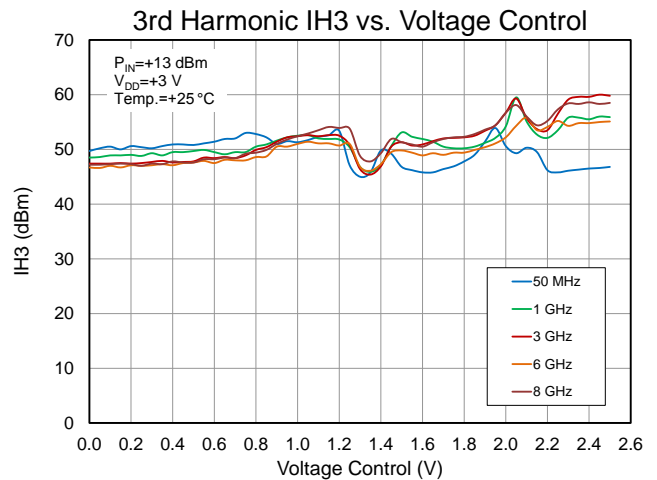
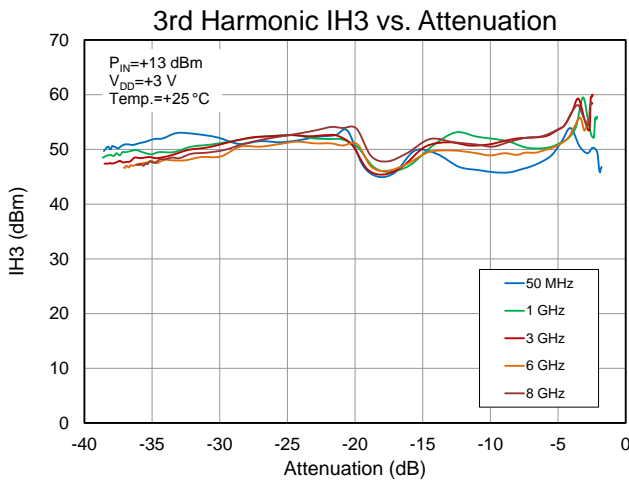
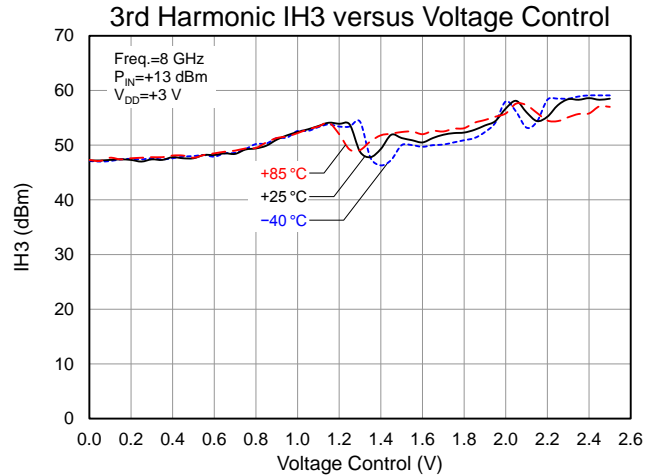
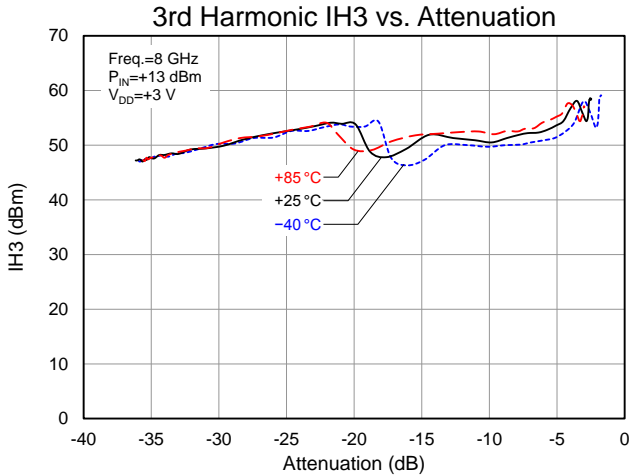

Measured Positive Attenuation Slope Performance

Test conditions unless otherwise noted: $V_{DD}=+3\text{ V}$, $\text{Temp}=+25\text{ }^{\circ}\text{C}$, includes PCB and connector losses.

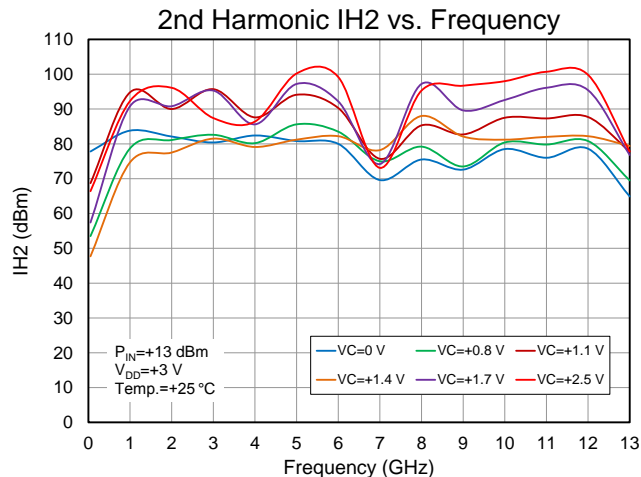
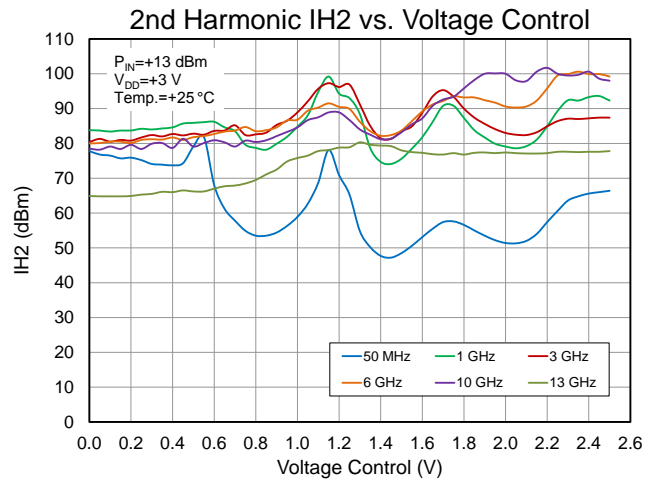
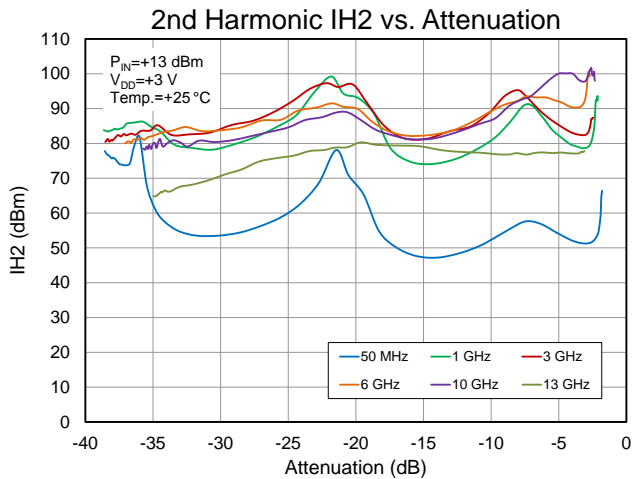
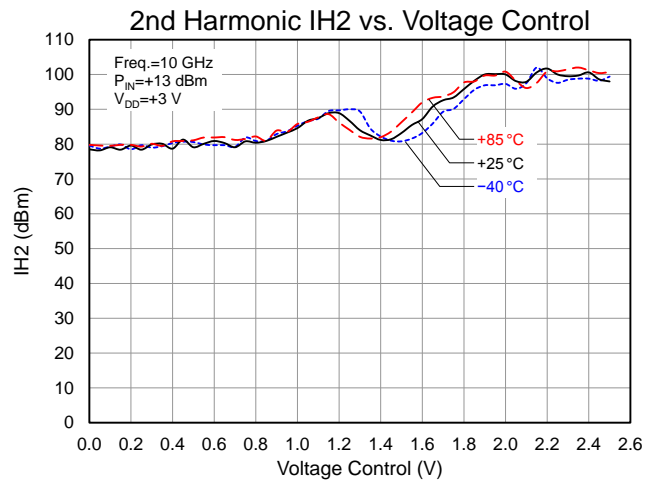
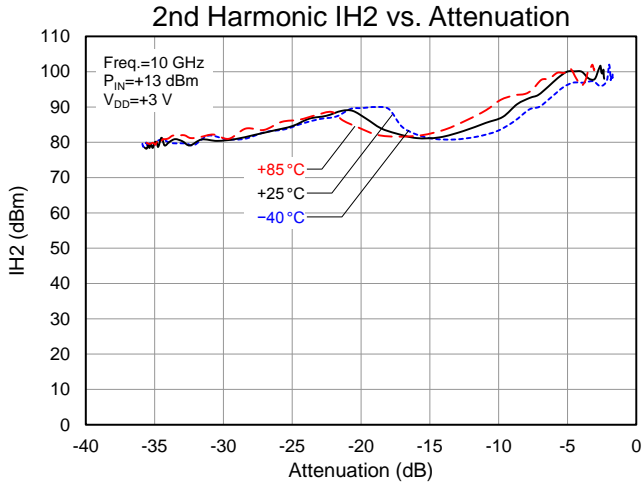

Measured Positive Attenuation Slope Performance

Test conditions unless otherwise noted: $V_{DD}=+3V$, $Temp.=+25^{\circ}C$, includes PCB and connector losses.

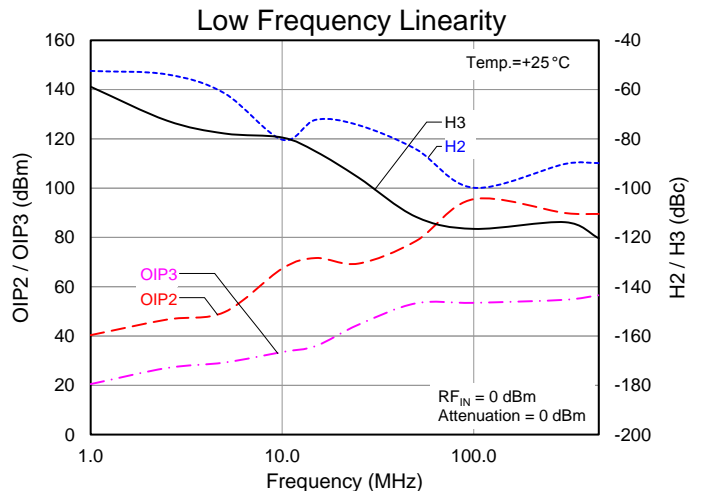
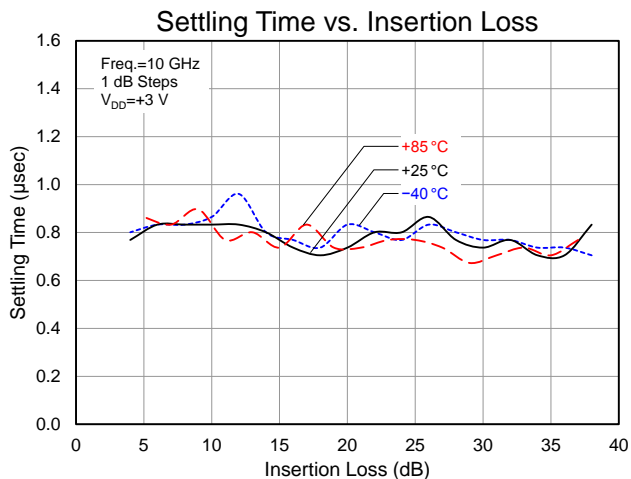
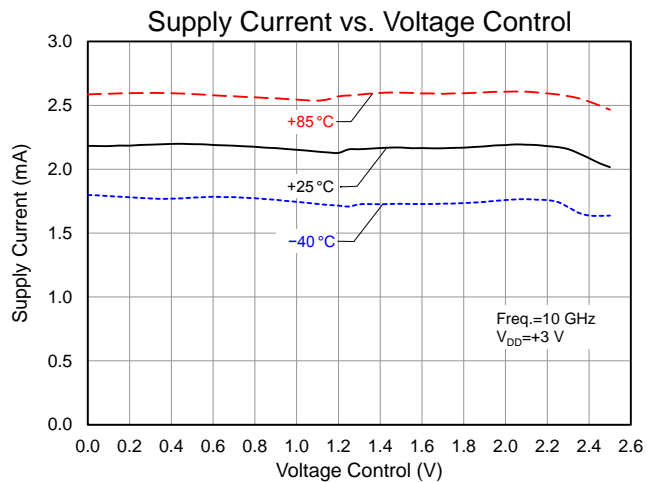
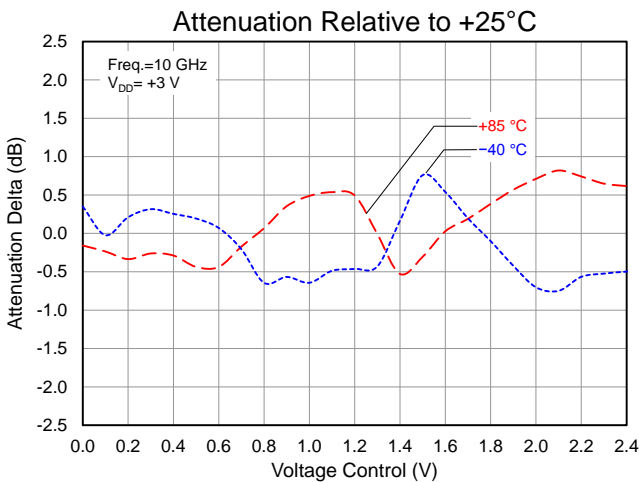
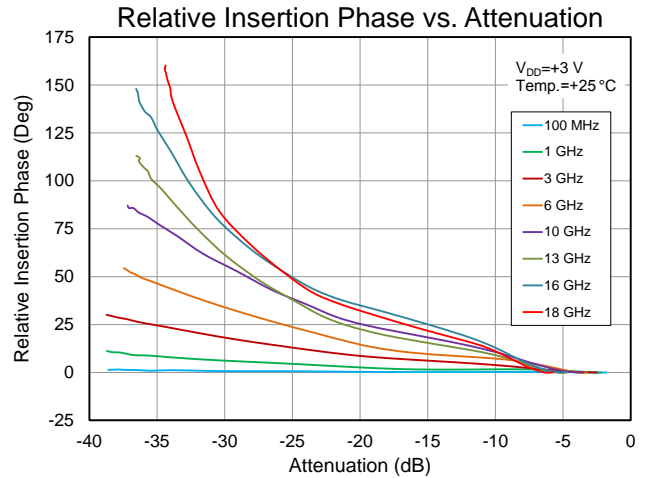
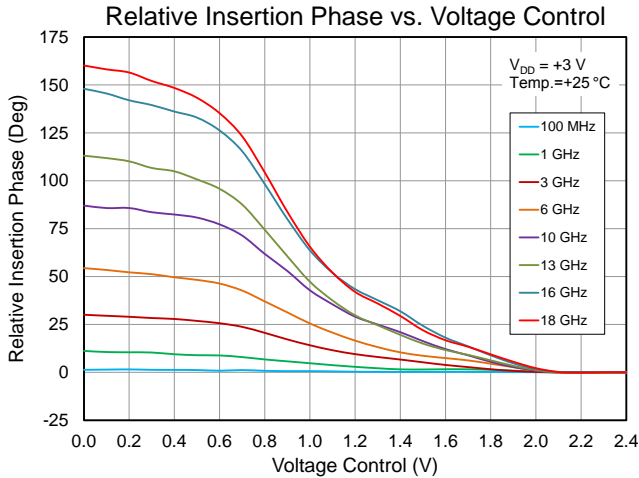

Measured Negative Attenuation Slope Performance

Test conditions unless otherwise noted: $V_{DD}=+3\text{ V}$, $\text{Temp}=+25\text{ }^{\circ}\text{C}$, PCB and connector losses de-embedded.

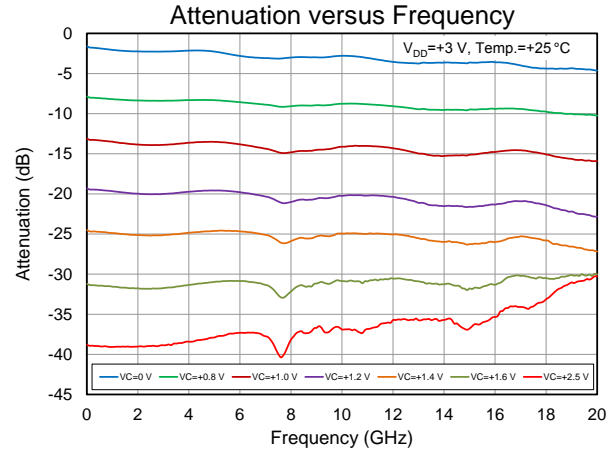
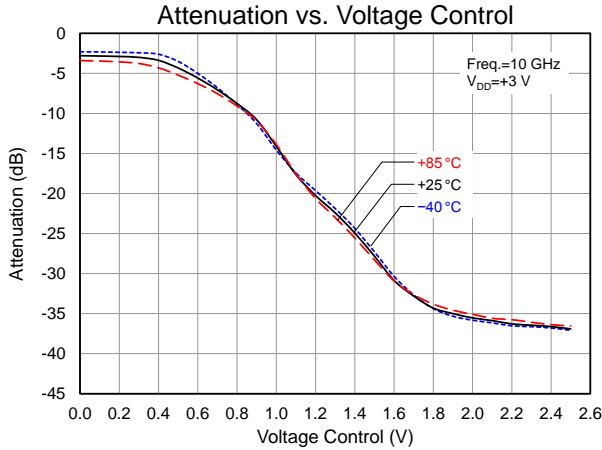

Measured Negative Attenuation Slope Performance

Test conditions unless otherwise noted: $V_{DD}=+3\text{ V}$, $\text{Temp}=+25\text{ }^{\circ}\text{C}$, includes PCB and connector losses.

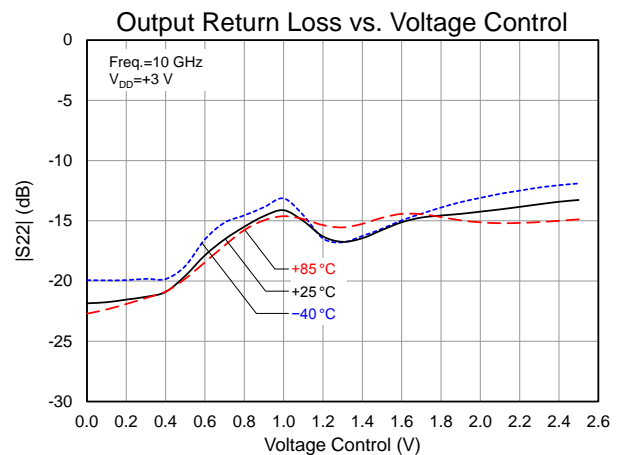
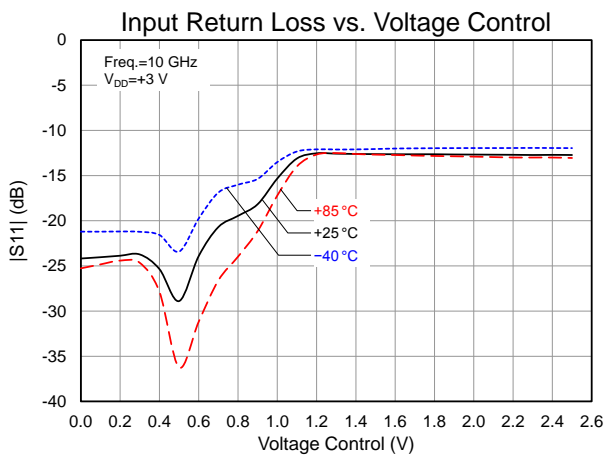
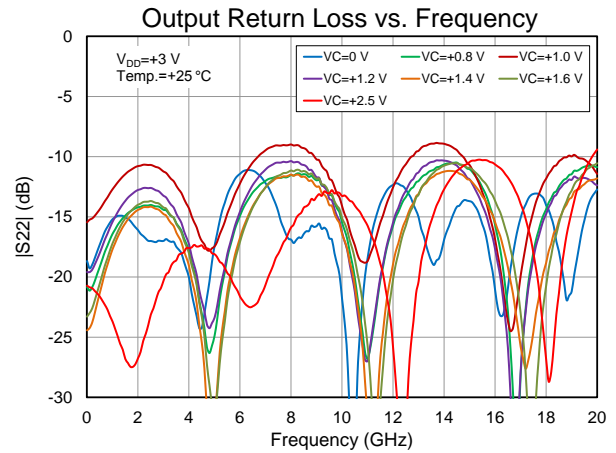
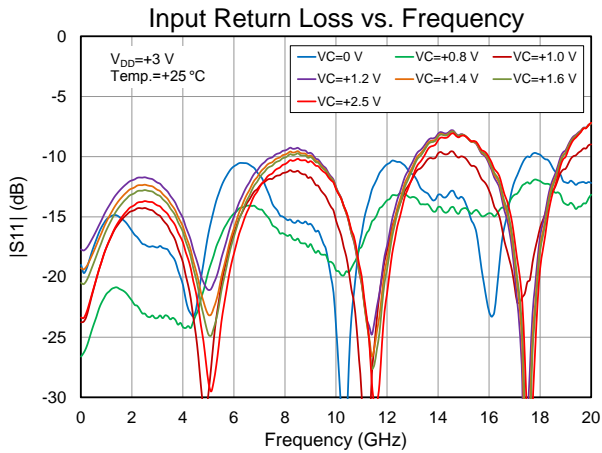

Measured Negative Attenuation Slope Performance

Test conditions unless otherwise noted: $V_{DD}=+3\text{ V}$, $\text{Temp}=+25\text{ }^{\circ}\text{C}$, includes PCB and connector losses.

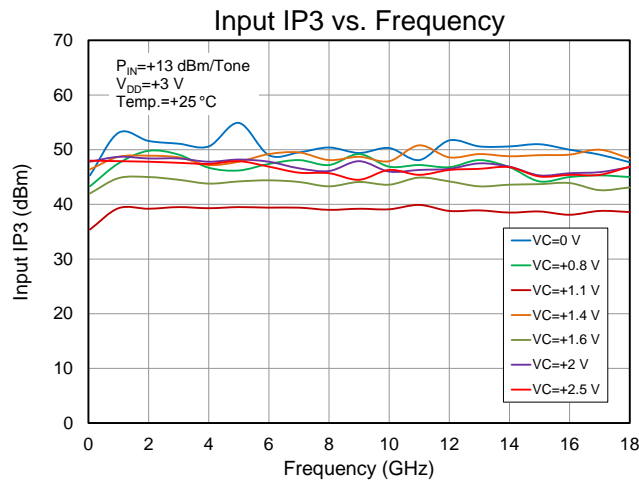
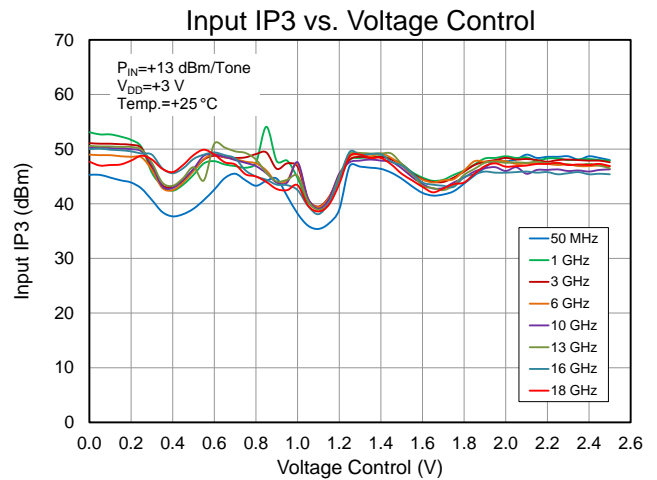
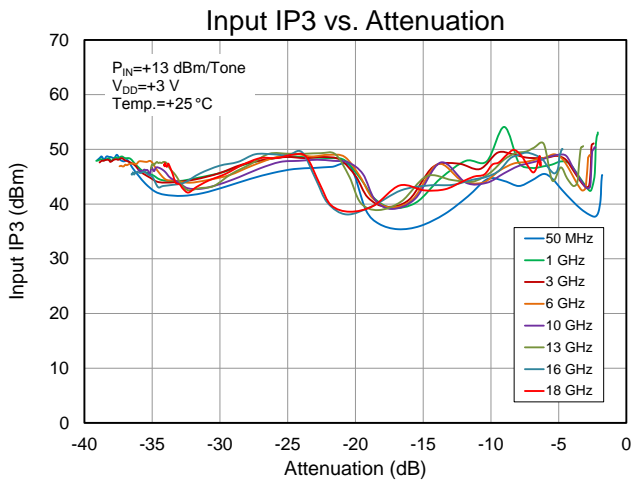
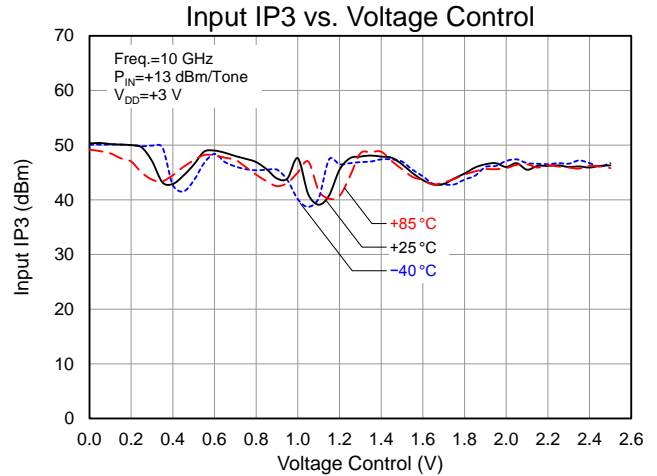
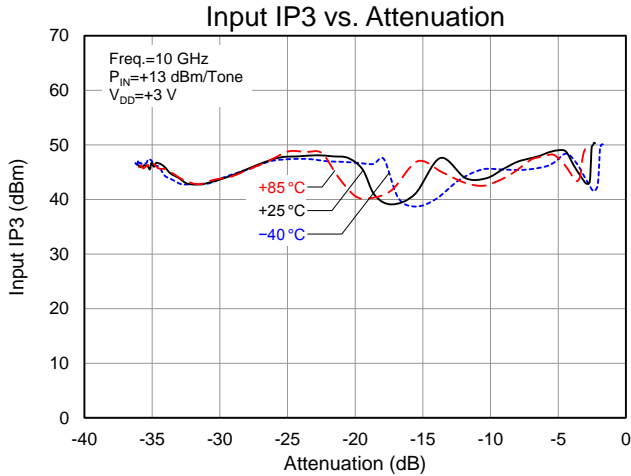

Measured Negative Attenuation Slope Performance

Test conditions unless otherwise noted: $V_{DD}=+3\text{ V}$, $\text{Temp}=+25\text{ }^{\circ}\text{C}$, includes PCB and connector losses.

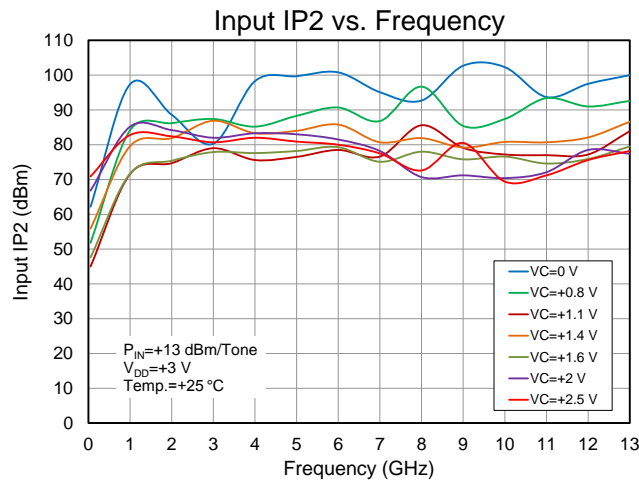
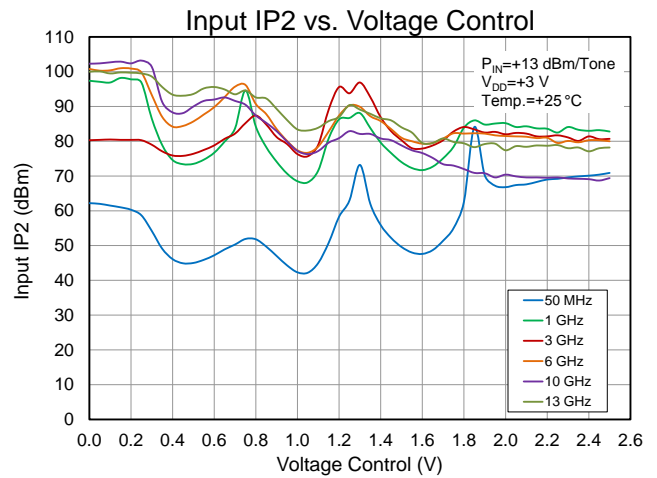
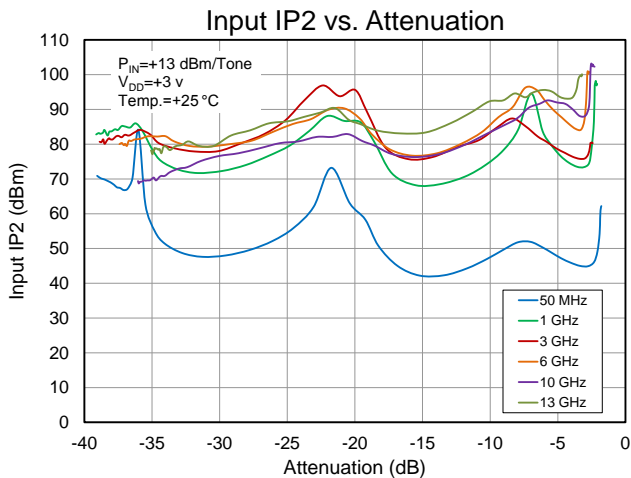
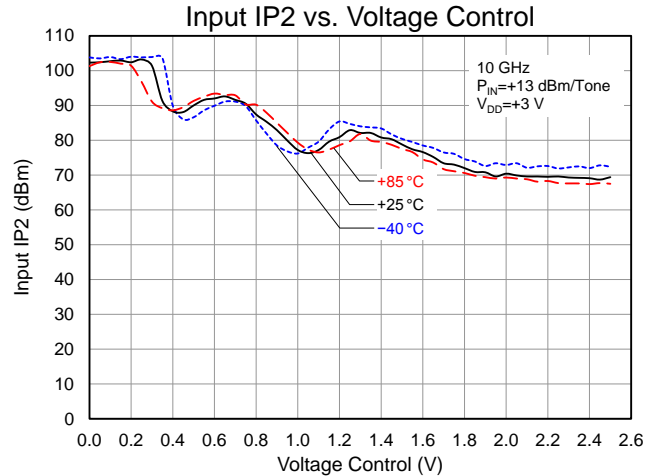
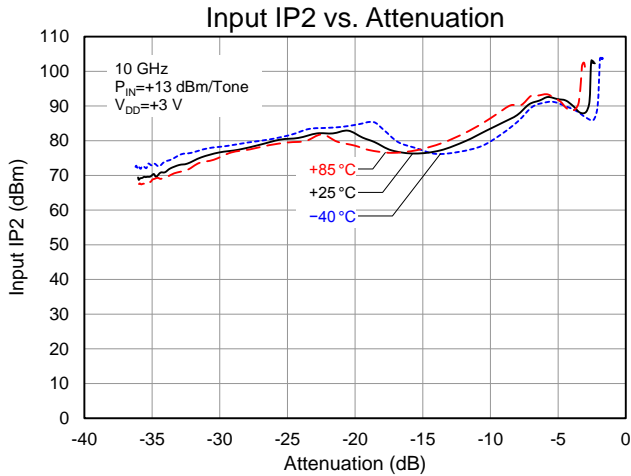

Measured Negative Attenuation Slope Performance

Test conditions unless otherwise noted: $V_{DD}=+3\text{ V}$, $\text{Temp}=+25\text{ }^{\circ}\text{C}$, includes PCB and connector losses.

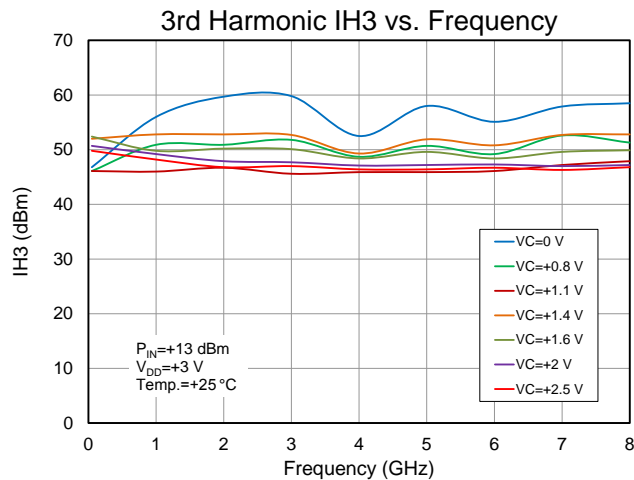
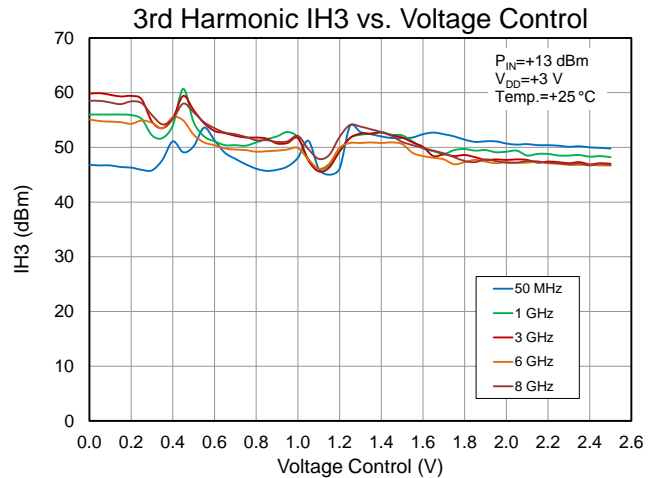
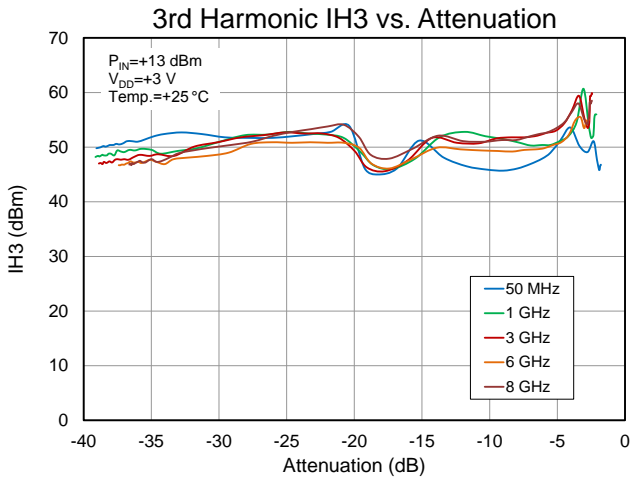
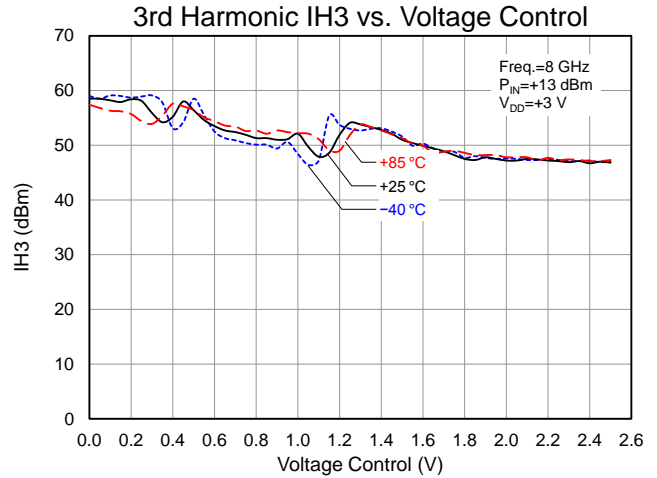
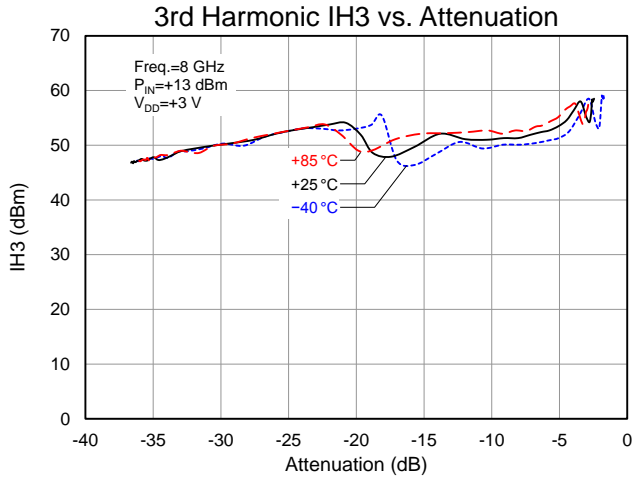

Measured Negative Attenuation Slope Performance

Test conditions unless otherwise noted: $V_{DD}=+3V$, $Temp.=+25^{\circ}C$, includes PCB and connector losses.

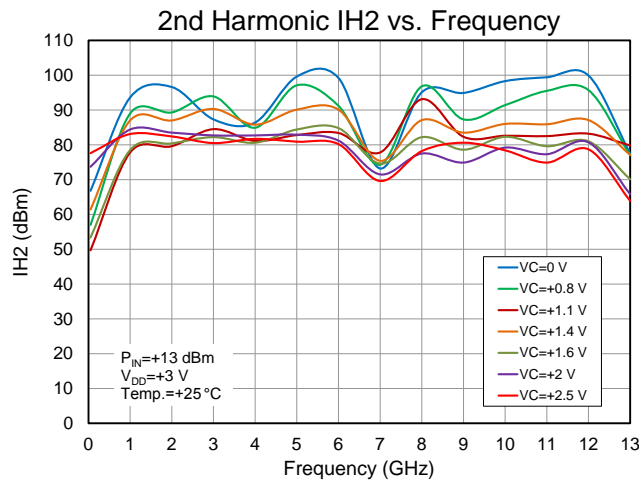
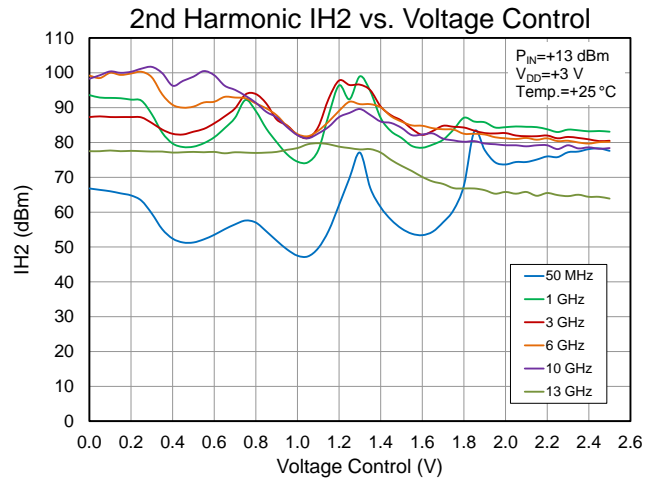
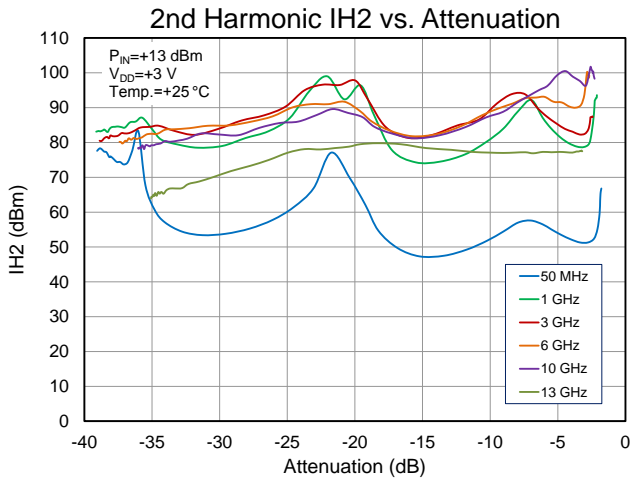
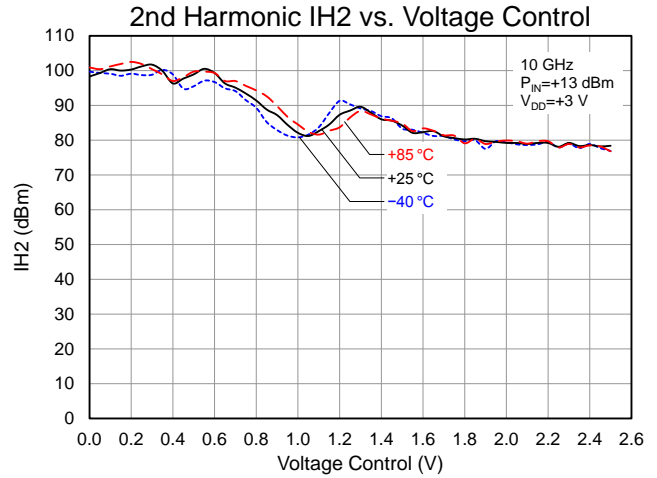
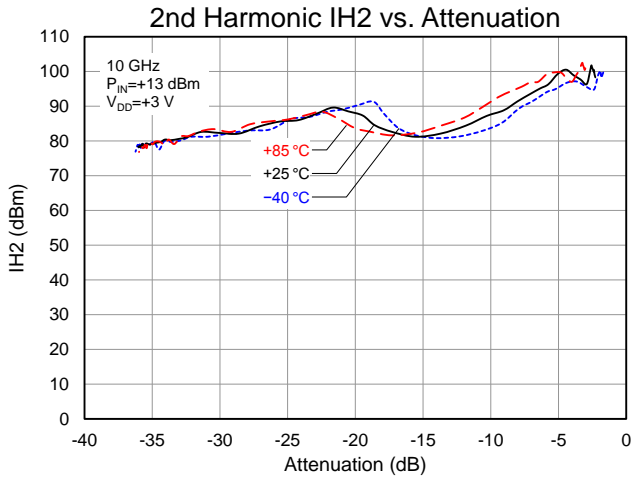

Measured Negative Attenuation Slope Performance

Test conditions unless otherwise noted: $V_{DD}=+3\text{ V}$, $\text{Temp}=+25\text{ }^{\circ}\text{C}$, includes PCB and connector losses.

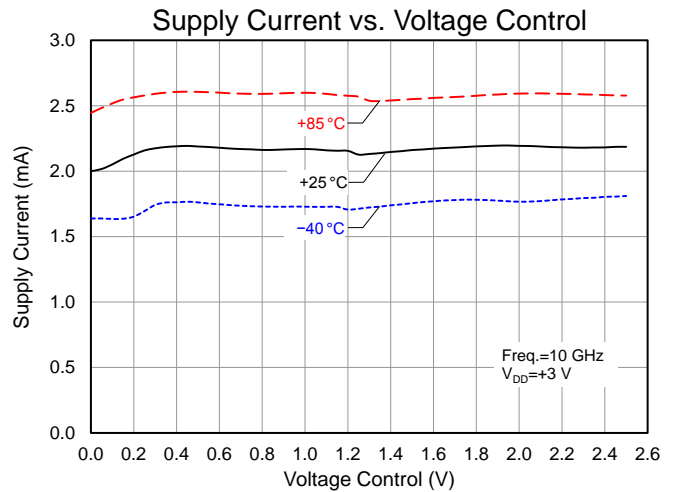
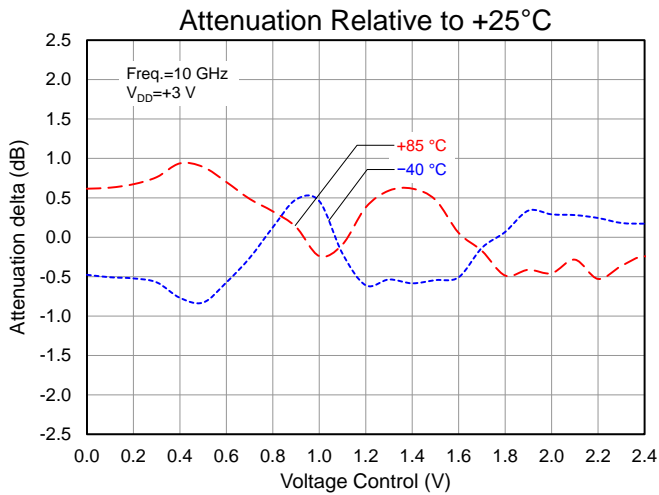
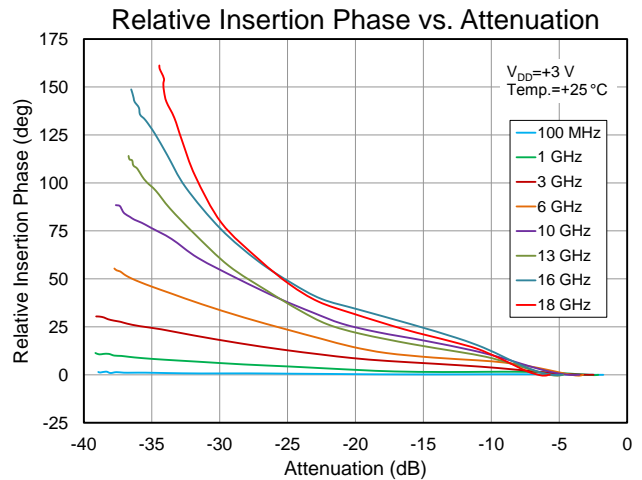
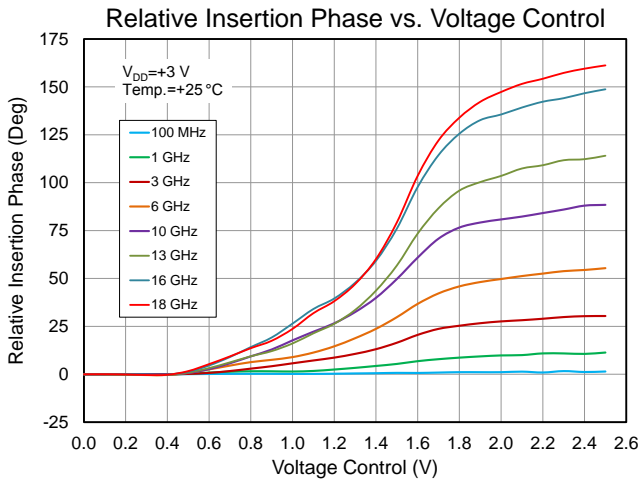

Evaluation Board Schematic

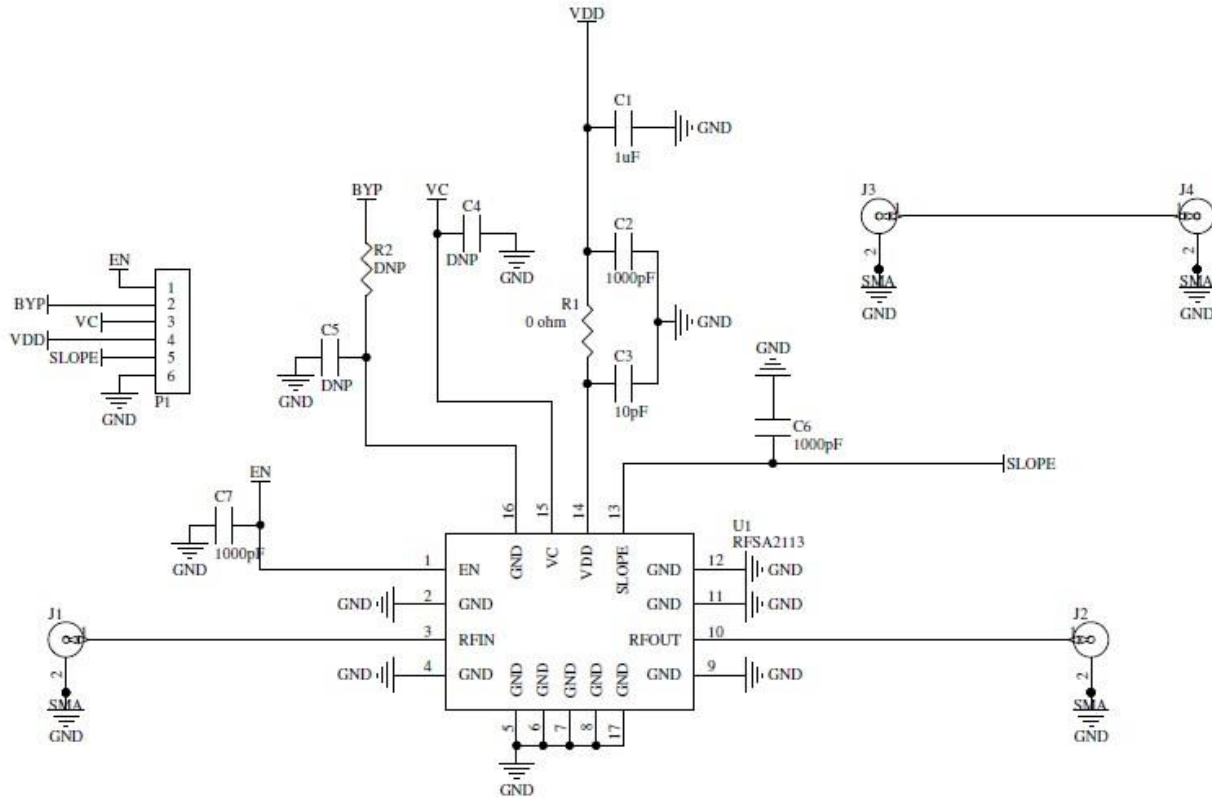

Evaluation Board Bill of Material

Ref. Des.	Value	Description	Manuf.	Part Number
U1	n/a	Voltage Controlled Attenuator VCA	Qorvo	RFSA2113
J1-J4	n/a	CONN, SMA, END LNCH, RND PIN, 0.039"	Gigalane Co., Ltd.	PSF-S01-002
P1	n/a	CONN, HDR, ST, 6-PIN, 0.100", T/H	Molex	22-28-4063
n/a	n/a	SA2113-410 Evaluation Board	DDI	SA2113-410(A)
C2, C6-C7	1000 pF	CAP, 10%, 25V, X7R, 0402	Murata Electronics	GRM155R71H102KA01D
C1	1 µF	CAP, 10%, 16V, X7R, 1206	Murata Electronics	GRM31MR71E105KC01L
C3	10 pF	CAP, 5%, 50V, C0G, 0402	Murata Electronics	GRM1555C1H100JZ01E
R1	0 Ω	RES, 0402	Kamaya, Inc	RMC1/16SJPTH
R2	-	DNP		
C4-C5	-	DNP		

Evaluation Board Assembly Drawing

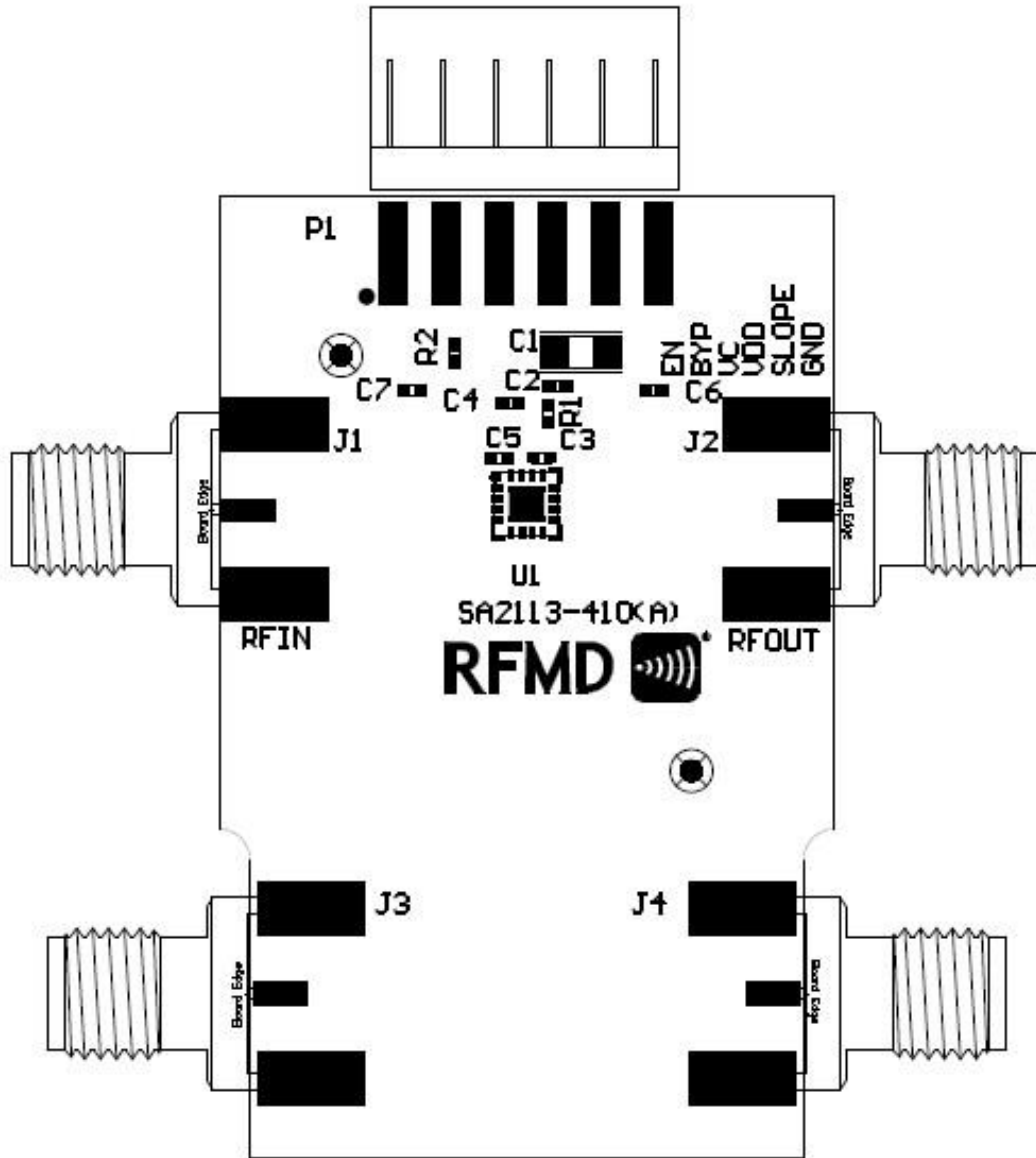

Pin Configuration and Description

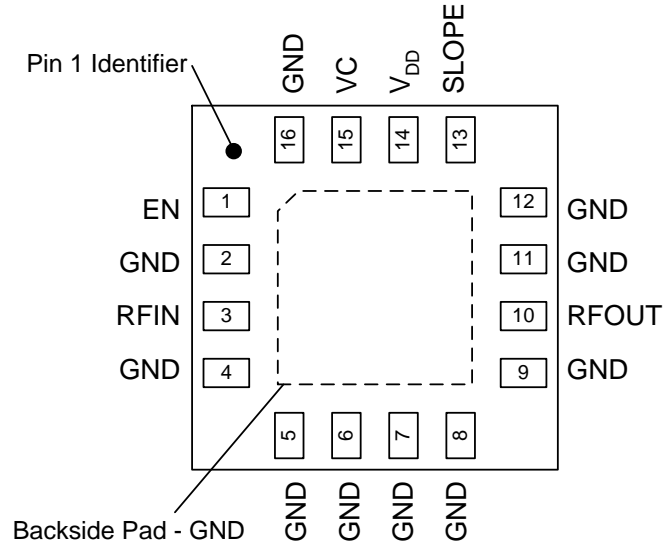

Pin No.	Label	Description
1	EN	Supply Current Enable Control. Connect to Logic Low to Enable. Connect to Logic High to Disable
2	GND	Ground Pin
3	RFIN	RF Input. Use External DC Block. RF input must be this pin to ensure linearity and thermal resistance specifications.
4	GND	Ground Pin
5	GND	Ground Pin
6	GND	Ground Pin
7	GND	Ground Pin
8	GND	Ground Pin
9	GND	Ground Pin
10	RFOUT	RF Output. Use External DC Block. RF output must be this pin to ensure linearity and thermal resistance specifications.
11	GND	Ground Pin
12	GND	Ground Pin
13	SLOPE	Attenuation Slope Control Connect to Logic Low to Enable Negative Attenuation Slope Connect to Logic High to Enable Positive Attenuation Slope
14	VDD	DC Supply
15	VC	Voltage Control
16	GND	Ground Pin
Backside Pad	RF/DC GND	

Package Marking and Dimensions

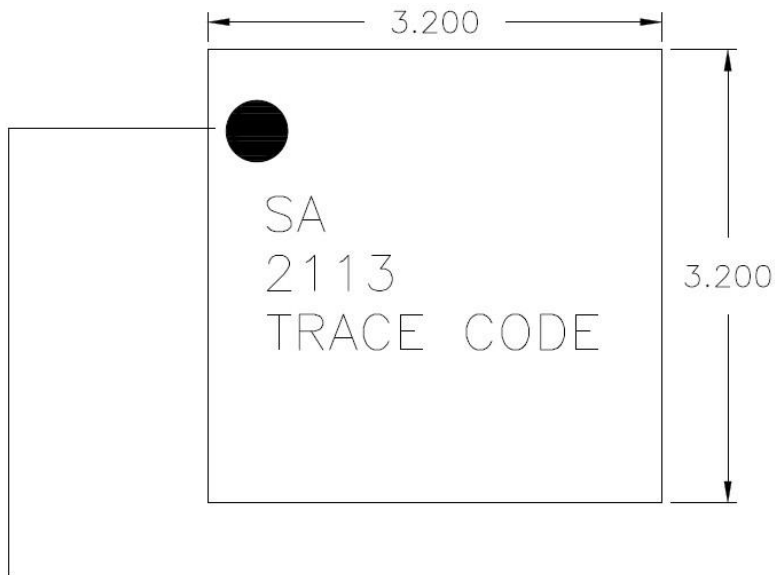
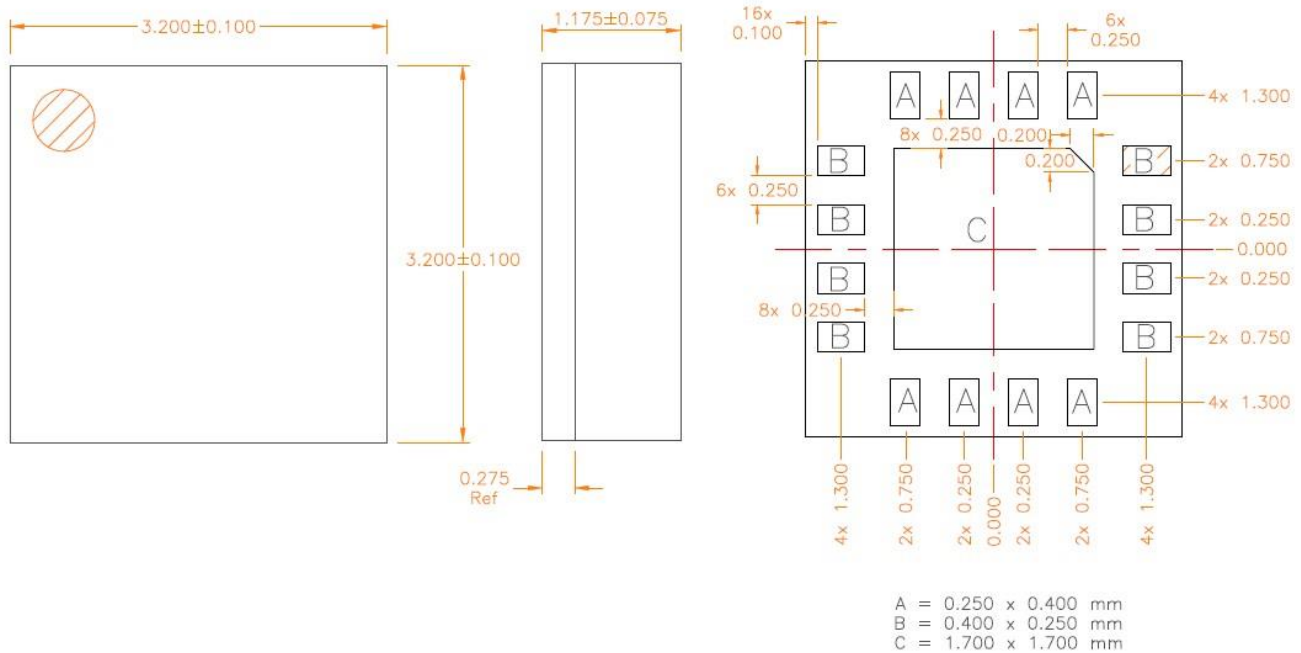

Pin 1 Indicator

Handling Precautions

Parameter	Rating	Standard
ESD – Human Body Model (HBM)	Class 1C	ESDA / JEDEC JS-001-2012
ESD – Charged Device Model (CDM)	Class C3	JEDEC JESD22-C101F
MSL – Moisture Sensitivity Level	Level 3	IPC/JEDEC J-STD-020



Caution!
ESD-Sensitive Device

Solderability

Compatible with both lead-free (260°C max. reflow temp.) and tin/lead (245°C max. reflow temp.) soldering processes. Solder profiles available upon request.

Contact plating: Refer to Manufacturing Notes Document

RoHS Compliance

This part is compliant with 2011/65/EU RoHS directive (Restrictions on the Use of Certain Hazardous Substances in Electrical and Electronic Equipment) as amended by Directive 2015/863/EU.

This product also has the following attributes:

- Lead Free
- Halogen Free (Chlorine, Bromine)
- Antimony Free
- TBBP-A (C₁₅H₁₂Br₄O₂) Free
- PFOS Free
- SVHC Free



Contact Information

For the latest specifications, additional product information, worldwide sales and distribution locations:

Web: www.qorvo.com

Tel: 1-844-890-8163

Email: customer.support@qorvo.com

Important Notice

The information contained herein is believed to be reliable; however, Qorvo makes no warranties regarding the information contained herein and assumes no responsibility or liability whatsoever for the use of the information contained herein. All information contained herein is subject to change without notice. Customers should obtain and verify the latest relevant information before placing orders for Qorvo products. The information contained herein or any use of such information does not grant, explicitly or implicitly, to any party any patent rights, licenses, or any other intellectual property rights, whether with regard to such information itself or anything described by such information. **THIS INFORMATION DOES NOT CONSTITUTE A WARRANTY WITH RESPECT TO THE PRODUCTS DESCRIBED HEREIN, AND QORVO HEREBY DISCLAIMS ANY AND ALL WARRANTIES WITH RESPECT TO SUCH PRODUCTS WHETHER EXPRESS OR IMPLIED BY LAW, COURSE OF DEALING, COURSE OF PERFORMANCE, USAGE OF TRADE OR OTHERWISE, INCLUDING THE IMPLIED WARRANTIES OF MERCHANTABILITY AND FITNESS FOR A PARTICULAR PURPOSE.**

Without limiting the generality of the foregoing, Qorvo products are not warranted or authorized for use as critical components in medical, life-saving, or life-sustaining applications, or other applications where a failure would reasonably be expected to cause severe personal injury or death.

Copyright 2016 © Qorvo, Inc. | Qorvo is a registered trademark of Qorvo, Inc.