

Coaxial Diplexer

ZDPLX-592+

50Ω 2.4 to 5.9 GHz
(2.4 - 2.5, 5.1- 5.9 GHz)



CASE STYLE: K18

The Big Deal

- Very Low insertion loss, 0.8 dB typical
- High co-channel Rejection, 40 dB typical
- Connectorized package

Product Overview

ZDPLX-592+ is a high performance hybrid diplexer with the lowpass port at 2.4 - 2.5 GHz and highpass port at 5.1 - 5.9 GHz. Built in a rugged connectorized package, this diplexer finds its application in Wi-Fi communication systems with high speed data rates.

Key Features

Feature	Advantages
Low passband insertion loss	Very low insertion loss ensures less signal loss through the device.
Excellent co-channel rejection	Co-channel rejection of 40 dB ensures unwanted spurious are eliminated
Connectorized package	Connectorized package is easy to interface with other devices and well suited for test setups.

Notes

- A. Performance and quality attributes and conditions not expressly stated in this specification document are intended to be excluded and do not form a part of this specification document.
B. Electrical specifications and performance data contained in this specification document are based on Mini-Circuit's applicable established test performance criteria and measurement instructions.
C. The parts covered by this specification document are subject to Mini-Circuits standard limited warranty and terms and conditions (collectively, "Standard Terms"); Purchasers of this part are entitled to the rights and benefits contained therein. For a full statement of the Standard Terms and the exclusive rights and remedies thereunder, please visit Mini-Circuits' website at www.minicircuits.com/MCLStore/terms.jsp



Coaxial Diplexer

ZDPLX-592+

50Ω 2.4 to 5.9 GHz (2.4-2.5, 5.1-5.9 GHz)

Maximum Ratings

Operating Temperature	-40°C to 85°C
Storage Temperature	-55°C to 100°C
RF Power Input	1 W

Permanent damage may occur if any of these limits are exceeded.

Coaxial Connections

HIGH PASS PORT	2
LOW PASS PORT	3
COMMON PORT	1

Outline Drawing

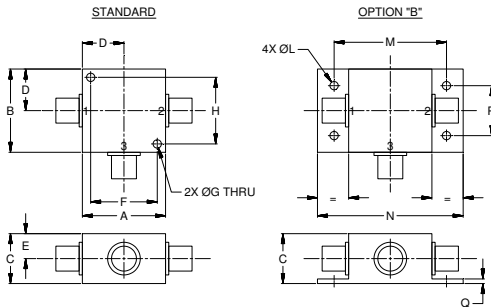

Outline Dimensions (inch mm)

A	B	C	D	E	F	G	H
1.25	1.25	.75	.63	.38	1.000	.125	1.000
31.75	31.75	19.05	16.00	9.65	25.40	3.18	25.40
J	K	L	M	N	P	Q	Wt.
--	--	.125	1.688	2.18	.75	.07	grams
--	--	3.18	42.88	55.37	19.05	1.78	70.0

Features

- Low insertion loss
- Very good co-channel rejection
- Connectorized package

Applications

- Wi-Fi communication systems
- Mobile satellite
- Private & public land mobile



CASE STYLE: K18

Connectors	Model	Price	Qty.
SMA	ZDPLX-592-S+	\$129.95 ea.	(1-9)
BRACKET (OPTION "B")		\$5.00 ea.	(1+)

+RoHS Compliant

The +Suffix identifies RoHS Compliance. See our web site for RoHS Compliance methodologies and qualifications

Electrical Specifications at 25°C

Parameter	Port	Frequency (GHz)	Min.	Typ.	Max.	Unit
Pass Band	Insertion Loss	Low Pass	2.4-2.5	-	0.8	1.2
		High Pass	5.1-5.9	-	0.9	1.7
	Return Loss	Low Pass	2.4-2.5	10	16	-
		High Pass	5.1-5.9	8	12	-
Common		2.4-2.5	10	16	-	
Stop Band Isolation	Low Pass	5.1-5.9	38	45	-	
	High Pass	2.4-2.5	35	40	-	

Typical Performance Data at 25°C

FREQUENCY (GHz)	INSERTION LOSS (dB)			RETURN LOSS (dB)	
	Low Pass Port	High Pass Port	Common Port	Low Pass Port	High Pass Port
0.01	0.02	102.05	47.95	45.76	0.00
0.10	0.07	85.34	30.41	30.62	0.05
0.70	0.26	62.39	18.14	18.21	0.18
1.50	0.33	51.65	24.76	22.92	0.19
2.00	0.53	47.66	16.04	15.78	0.21
2.40	0.65	42.87	17.43	17.53	0.24
2.50	0.67	41.53	22.19	23.52	0.24
2.70	1.11	37.66	14.34	15.54	0.27
2.84	3.79	32.31	4.78	6.23	0.30
2.88	6.31	30.45	2.79	4.05	0.30
2.98	18.99	27.35	0.91	1.53	0.33
3.00	23.06	26.91	0.83	1.36	0.33
3.08	30.72	25.43	0.69	0.96	0.35
3.20	24.69	23.38	0.65	0.69	0.39
3.30	25.39	21.72	0.64	0.58	0.42
3.40	27.25	20.07	0.69	0.51	0.45
3.54	30.96	17.82	0.82	0.45	0.53
4.00	46.38	10.20	3.02	0.38	1.18
4.30	43.45	5.32	3.64	0.35	2.62
4.50	41.58	3.11	5.43	0.34	4.59
5.10	45.63	0.77	19.79	0.31	18.86
5.90	48.45	0.71	18.00	0.25	17.36

Functional Schematic

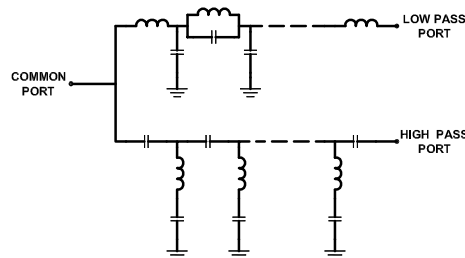

Notes

- Performance and quality attributes and conditions not expressly stated in this specification document are intended to be excluded and do not form a part of this specification document.
- Electrical specifications and performance data contained in this specification document are based on Mini-Circuit's applicable established test performance criteria and measurement instructions.
- The parts covered by this specification document are subject to Mini-Circuit's standard limited warranty and terms and conditions (collectively, "Standard Terms"); Purchasers of this part are entitled to the rights and benefits contained therein. For a full statement of the Standard Terms and the exclusive rights and remedies thereunder, please visit Mini-Circuit's website at www.minicircuits.com/MCLStore/terms.jsp



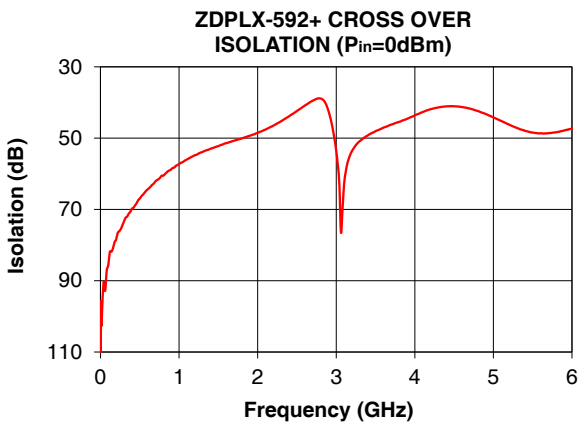
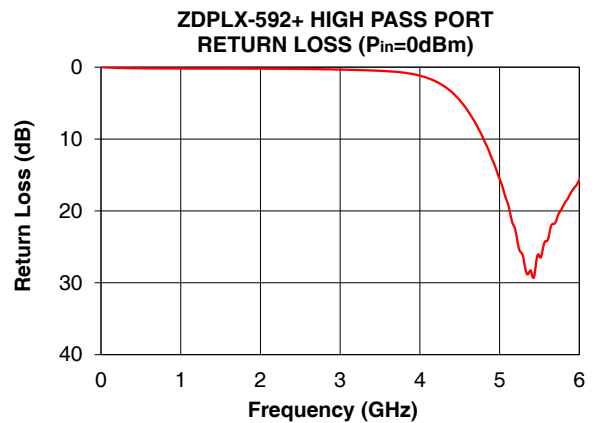
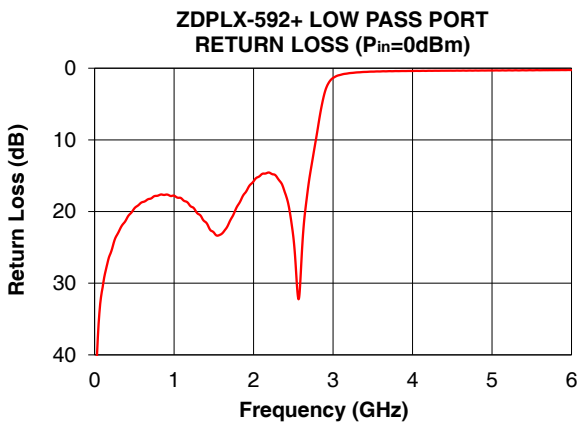
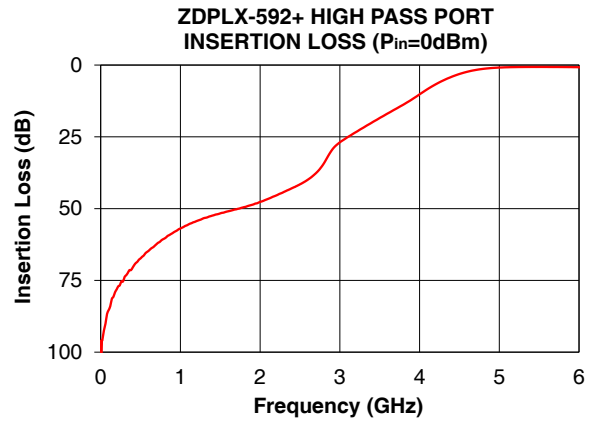
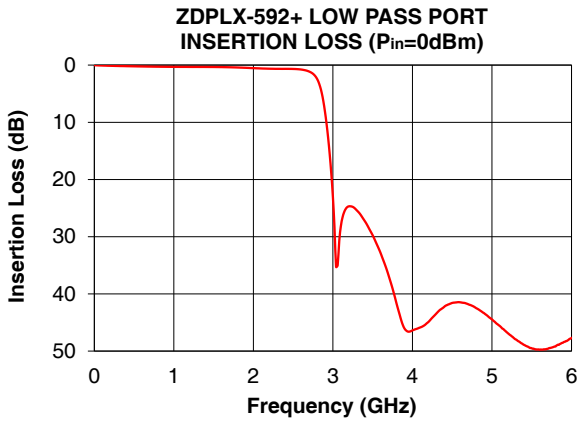

Notes

- A. Performance and quality attributes and conditions not expressly stated in this specification document are intended to be excluded and do not form a part of this specification document.
- B. Electrical specifications and performance data contained in this specification document are based on Mini-Circuit's applicable established test performance criteria and measurement instructions.
- C. The parts covered by this specification document are subject to Mini-Circuits standard limited warranty and terms and conditions (collectively, "Standard Terms"); Purchasers of this part are entitled to the rights and benefits contained therein. For a full statement of the Standard Terms and the exclusive rights and remedies thereunder, please visit Mini-Circuits' website at www.minicircuits.com/MCLStore/terms.jsp

