

Features

- 26 dB Gain, 45 - 1200 MHz Applications
- 28 dB Gain, 45 - 1000 MHz Applications
- 24 V DC Supply
- Differential Inputs and Outputs
- Low Distortion
- Lead-Free TSSOP-16LD-EP package
- Halogen-Free "Green" Mold Compound
- RoHS* Compliant

Description

The MAAM-011177 is a broadband GaAs MMIC differential amplifier in a lead-free TSSOP-16LD-EP package. It is designed for integration in a 75 Ω push-pull, low-distortion amplifier circuit.

This amplifier is ideally suited for use in CATV applications where low noise figure and low distortion are required.

Ordering Information^{1,2}

Part Number	Package
MAAM-011177	Bulk Packaging
MAAM-011177-TR1000	1000 Piece Reel
MAAM-011177-TR2500	2500 Piece Reel
MAAM-011177-1SMB	Sample Test Board

1. Reference Application Note M513 for reel size information.
2. All sample boards include 5 loose parts.

Functional Schematic

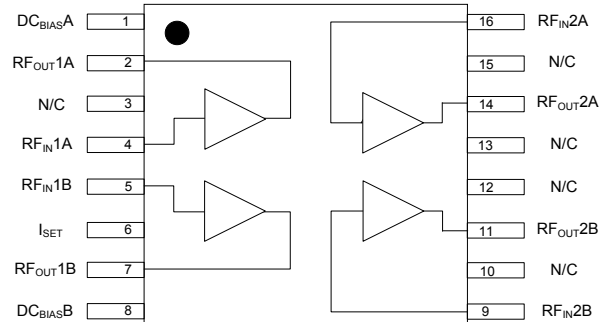

Pin Configuration³

Pin No.	Pin Name	Description
1	DC _{BIAS} A	Amp1A DC Bias
2	RF _{OUT} 1A	Amp1A RF _{OUT}
3	N/C	No Connection
4	RF _{IN} 1A	Amp1A RF _{IN}
5	RF _{IN} 1B	Amp1B RF _{IN}
6	I _{SET}	Current Set
7	RF _{OUT} 1B	Amp1B RF _{OUT}
8	DC _{BIAS} B	Amp1B DC Bias
9	RF _{IN} 2B	Amp2B RF _{IN}
10	N/C	No Connection
11	RF _{OUT} 2B	Amp2B RF _{OUT}
12	N/C	No Connection
13	N/C	No Connection
14	RF _{OUT} 2A	Amp2A RF _{OUT}
15	N/C	No Connection
16	RF _{IN} 2A	Amp2A RF _{IN}
17	Paddle ⁴	RF and DC Ground

3. MACOM recommends grounding pin 3 and floating (leaving unconnected) pins 10, 12, 13, and 15.
4. The exposed pad centered on the package bottom must be connected to RF, DC and thermal ground.

* Restrictions on Hazardous Substances, European Union Directive 2011/65/EU.

Electrical Specifications⁵: Freq: 45 - 1200 MHz, T_A = 25°C, V_{DD} = 24 V, Z₀ = 75 Ω

Parameter	Test Conditions	Units	Min.	Typ.	Max.
Gain	45 MHz 1000 MHz 1200 MHz	dB	24.0 25.0 25.0	25.0 26.0 26.4	—
Gain Slope	—	dB	—	1.4	—
Noise Figure	45 MHz 1200 MHz	dB	—	4.5 4.0	—
Reverse Isolation	—	dB	—	36	—
Input Return Loss	45 – 1200 MHz	dB	17	19	—
Output Return Loss	45 – 1200 MHz	dB	18	20	—
P1dB	1200 MHz	dBm	—	24.5	—
OIP3	1200 MHz, 6 MHz Spacing, +15 dBm P _{OUT} per tone	dBm	—	43	—
OIP2	1200 MHz, 6 MHz Spacing, +15 dBm P _{OUT} per tone	dBm	—	63	—
CTB ⁶	79 NTSC V _O = +44 dBmV Flat 79 NTSC + 75 ATSC V _O = +44 dBmV Flat	dBc	—	-74 -72	-68 —
CSO ^{6,7}	79 NTSC V _O = +44 dBmV Flat 79 NTSC + 75 ATSC V _O = +44 dBmV Flat	dBc	—	-75 -75	-67 —
XMOD ⁶	79 NTSC V _O = +44 dBmV Flat 79 NTSC + 75 ATSC V _O = +44 dBmV Flat	dBc	—	-65 -64	—
CCNR ⁶	79 NTSC + 75 ATSC V _O = +44 dBmV Flat	dBc	—	68	—
I _{DD}	+24 Volts	mA	—	265	280

5. See 'Off-Chip Component Values: 45 - 1200 MHz Applications' for the sample board BOM which corresponds to these specifications.

6. Digital channels are -6 dB relative to analog channels.

7. See Typical Performance Curves for frequency response of CSOL and CSOH.

Absolute Maximum Ratings^{8,9,10}

Parameter	Absolute Maximum
RF Input Power	2 dBm
Voltage	30 Volts
Operating Temperature	-40°C to +110°C
Junction Temperature ¹¹	+160°C
Storage Temperature	-65°C to +150°C

8. Exceeding any one or a combination of these limits may cause permanent damage to this device.
9. MACOM does not recommend sustained operation near these survivability limits.
10. Operating at nominal conditions with $T_J \leq +160^\circ\text{C}$ will ensure $\text{MTTF} > 1 \times 10^6$ hours.
11. Junction Temperature (T_J) = $T_C + \Theta_{jc} * (V * I)$
Typical thermal resistance (Θ_{jc}) = 5.5°C/W .
 - a) For $T_C = 25^\circ\text{C}$,
 $T_J = 60^\circ\text{C @ 24 V, 265 mA}$
 - b) For $T_C = 110^\circ\text{C}$,
 $T_J = 145^\circ\text{C @ 24 V, 265 mA}$

Handling Procedures

Please observe the following precautions to avoid damage:

Static Sensitivity

Gallium Arsenide Integrated Circuits are sensitive to electrostatic discharge (ESD) and can be damaged by static electricity. Proper ESD control techniques should be used when handling these devices.

An external protection circuit using an inexpensive anti-parallel diode pair can be used to protect the IC. Please reference application note AN3028 on <http://www.macom.com> for further detail.

Typical Performance Curves: 45 - 1200 MHz Applications

Gain

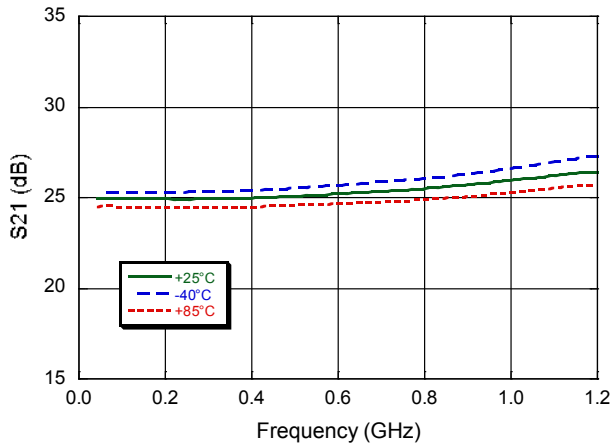

Gain to 2 GHz

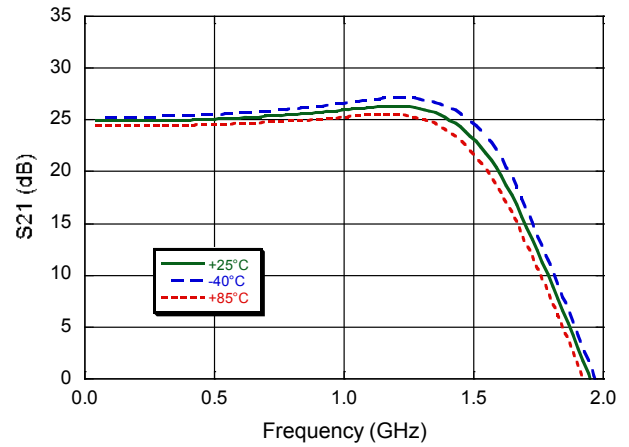

Input Return Loss

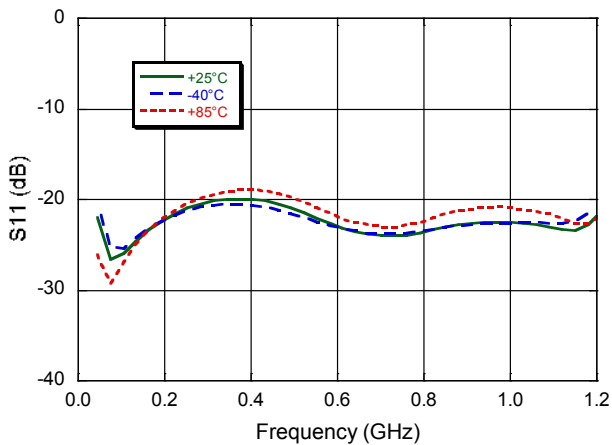

Output Return Loss

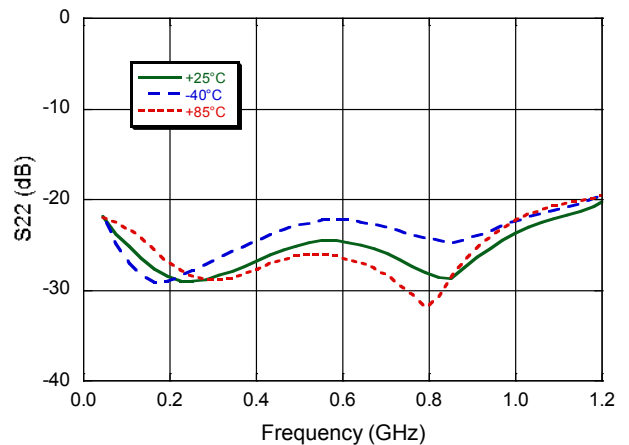

Reverse Isolation

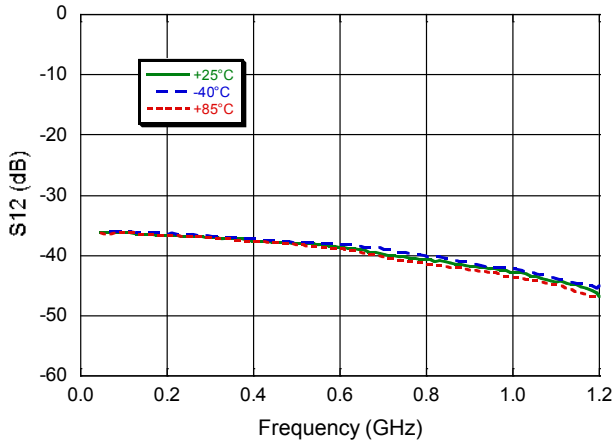

Noise Figure

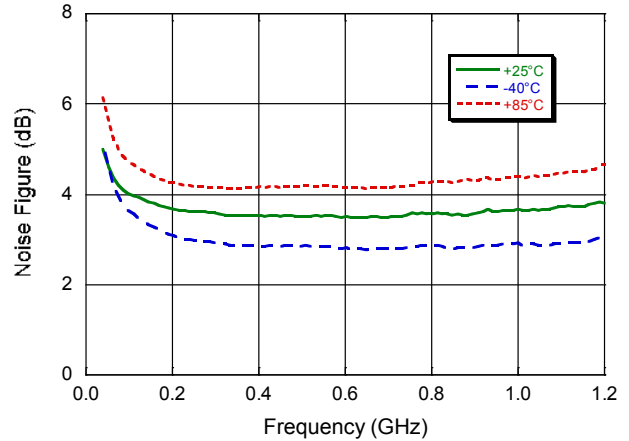

Typical Distortion Performance Curves: 79 NTSC $V_0 = +44$ dBmV Flat @ +25°C

CTB

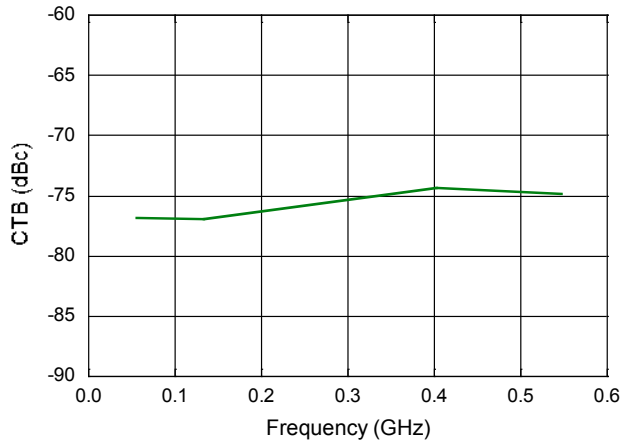

XMOD

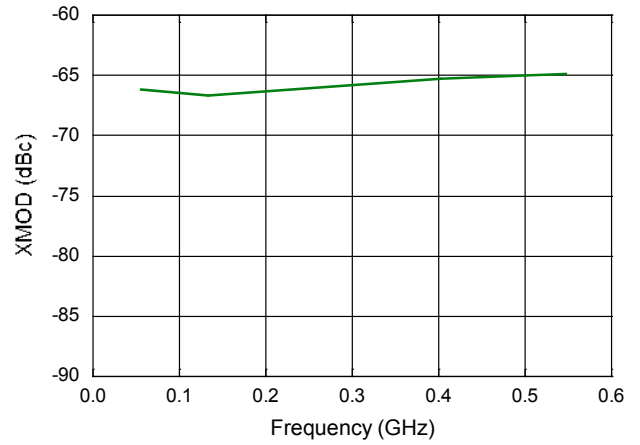

CSOL

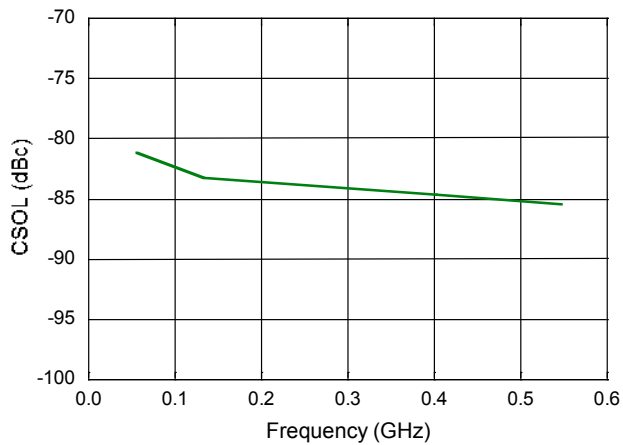

CSOH

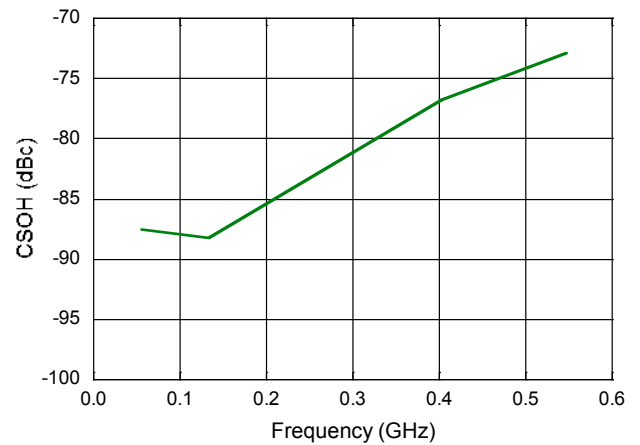

Push-Pull CATV Amplifier 45 - 1200 MHz

Rev. V2

Typical Distortion Performance Curves: 79 NTSC + 75 ATSC $V_0 = +44$ dBmV Flat @ +25°C

CTB

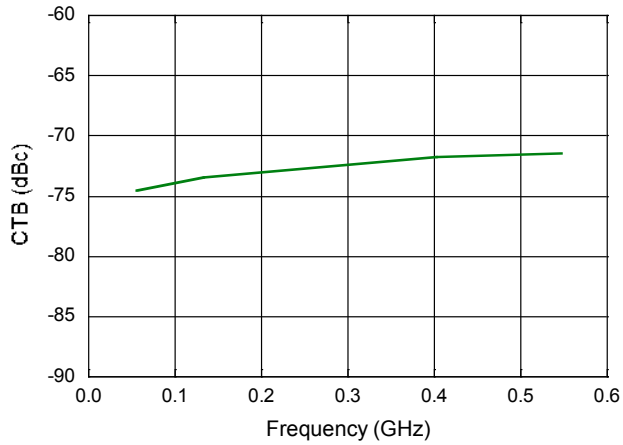

XMOD

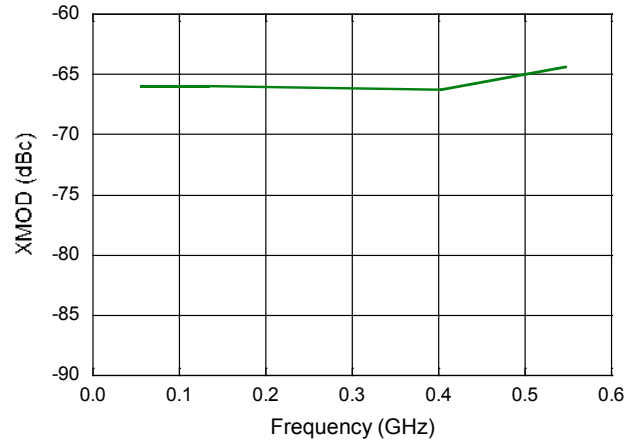

CSOL

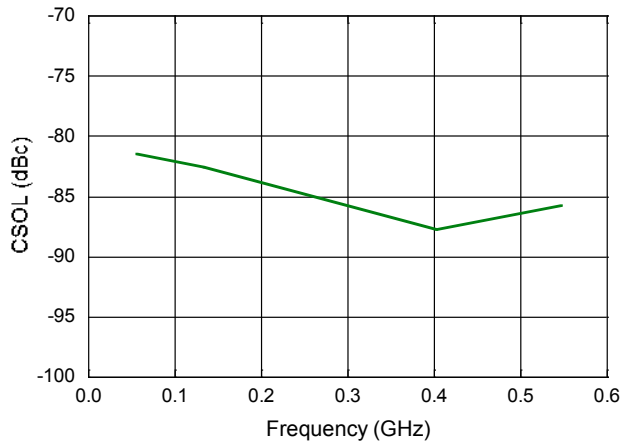

CSOH

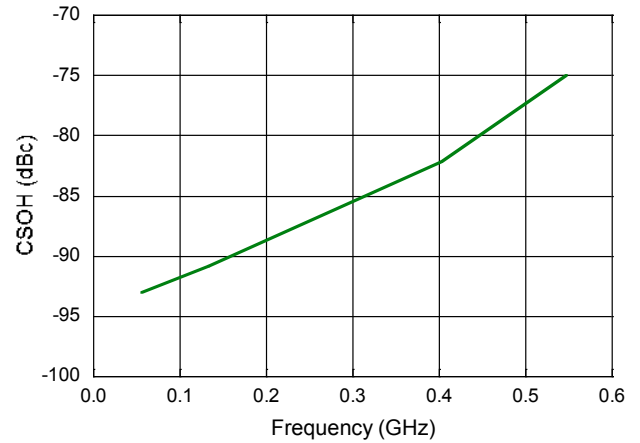

CCNR

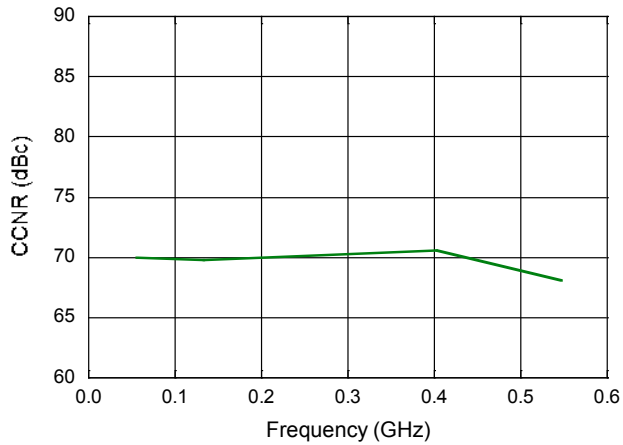

Push-Pull CATV Amplifier 45 - 1200 MHz

Rev. V2

Schematic Including Off-Chip Components

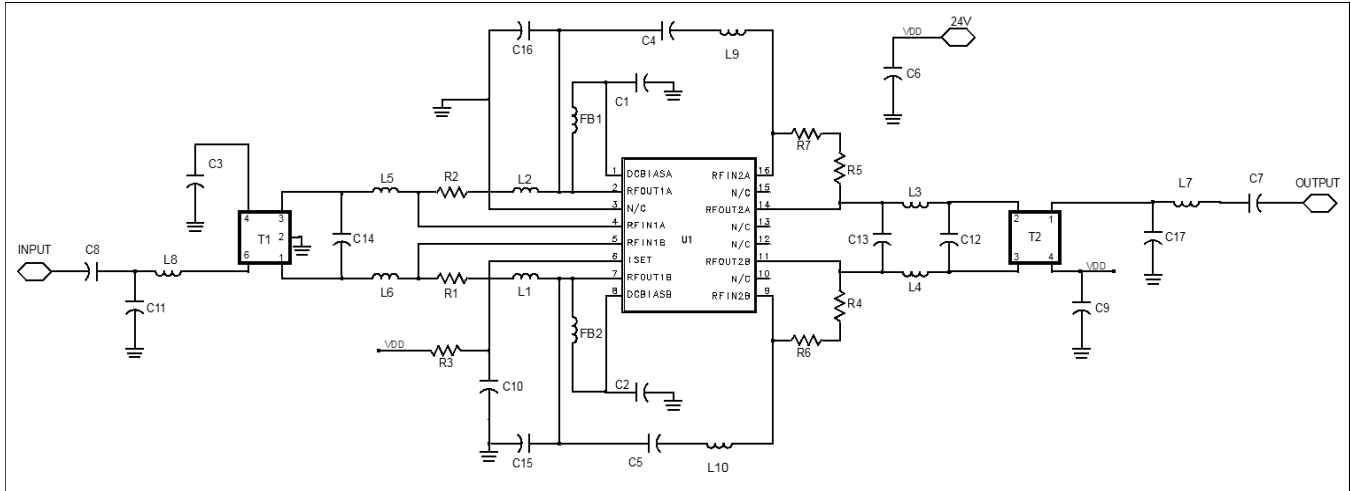

Off-Chip Component Values: 45 - 1200 MHz Applications

Component	Value	Package	QTY	Vendor	Part Number
C1 - C10	0.01 μ F	0402	10	MURATA	GRM155R71H103KA88D
C11	0.5 pF	0402	1	AVX	ACCU-P 04023J0R5AB
C12	0.4 pF	0402	1	AVX	ACCU-P 04023J0R4AB
C13	0.2 pF	0402	1	AVX	ACCU-P 04023J0R2AB
C14	0.8 pF	0402	1	AVX	ACCU-P 04023J0R8AB
C15, C16	1.2 pF	0402	2	AVX	ACCU-P 04023J1R2AB
C17	0.1 pF	0402	1	AVX	ACCU-P 04023J0R1AB
L1 - L4	15 nH	0402	4	COILCRAFT	0402CS-15NXJL
L5, L6	3.9 nH	0402	2	COILCRAFT	0402CS-3N9XJL
L7	0 Ω	0402	1	—	SHORT — NOT USED
L8	3.3 nH	0402	1	COILCRAFT	0402CS-3N3XJL
L9, L10	2 nH	0402	2	COILCRAFT	0402CS-2N0XJL
R1, R2	255 Ω	0402	2	PANASONIC	ERJ-2RKF2550X
R3	2610 Ω	0402	1	PANASONIC	ERJ-2RKF2611X
R4, R5	453 Ω	0402	2	PANASONIC	ERJ-2RKF4530X
R6, R7	0 Ω	0402	2	—	SHORT — NOT USED
FB1, FB2	1800 Ω	0402	2	MURATA	BLM15HD182SN1D
T1	1:1	—	1	MACOM	MABA-010321-CT1A42
T2	1:3	—	1	MACOM	MABA-010441-CT38A0

7

M/A-COM Technology Solutions Inc. (MACOM) and its affiliates reserve the right to make changes to the product(s) or information contained herein without notice. Visit www.macom.com for additional data sheets and product information.

For further information and support please visit:
<https://www.macom.com/support>

Evaluation Board Layout

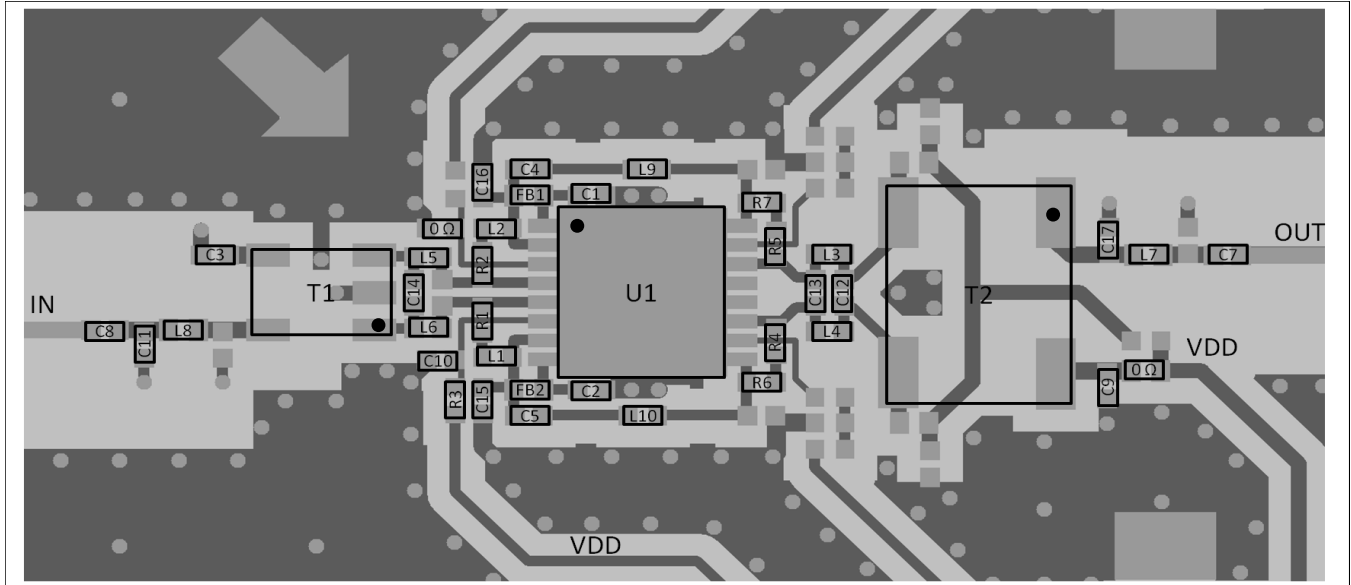

Evaluation Board Assembly^{12,13}

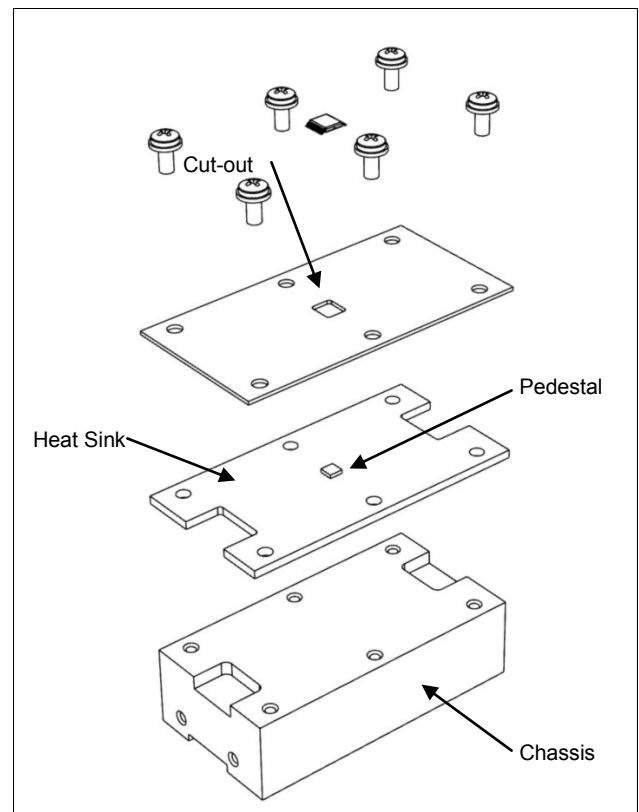
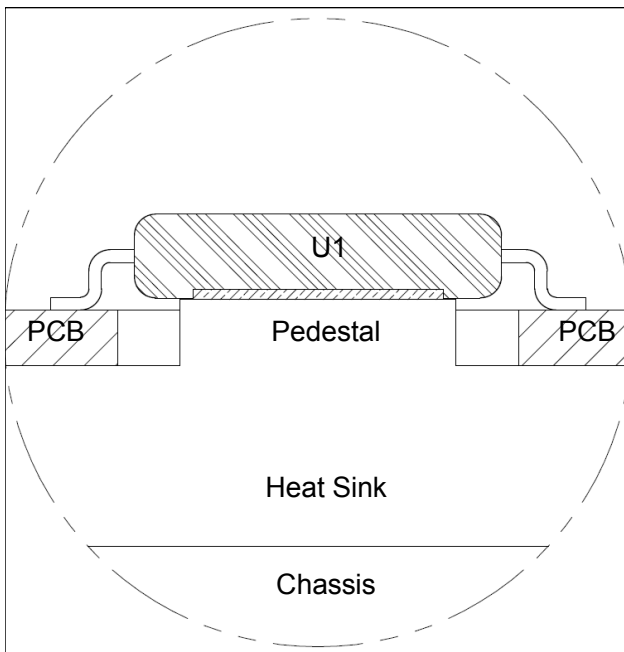

12. Due to the high power dissipation of this part, a heat sink must be attached to the printed circuit board.
13. The recommended assembly uses a heat sink with a pedestal. The printed circuit board has a cut-out under the part and the lead frame of the part is soldered directly to the heat sink pedestal as shown. The heat sink should be connected to the system chassis.

Push-Pull CATV Amplifier 45 - 1200 MHz

Rev. V2

Recommended Thermal Via Array

If a thermal pedestal is not desired, a dense through-via pattern with copper fill or sufficient hole plating is required for operation at a reliable junction temperature. Generally, filled vias and thin substrates are preferable.

An example layout using 10-mil (0.254 mm) finished hole diameter, 62-mil (1.575 mm) finished board thickness is seen at right: $T_J = 145^\circ\text{C}$ with PCB bottom heated to 85°C using 1.5-mil (38 micron) minimum copper via plating. Estimated exposed pad temperature was $T_C = 110^\circ\text{C}$. It is recommended that thermal vias extend beyond the exposed pad and amplifier package as shown.

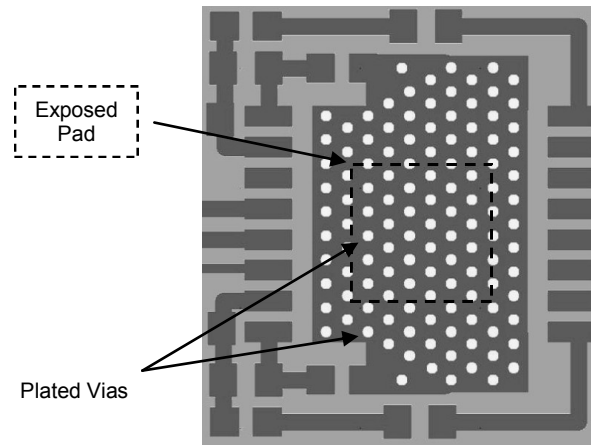

Lead Free TSSOP 16-lead exposed paddle[†]

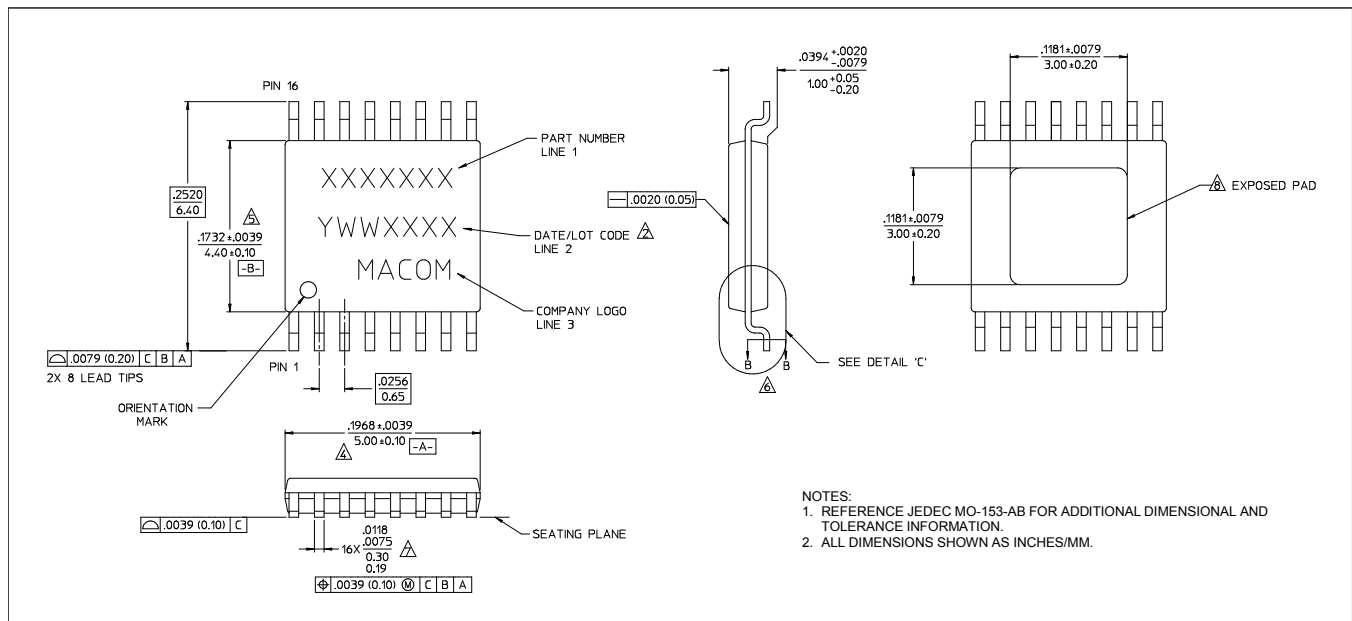

[†] Reference Application Note M538 for lead-free solder reflow recommendations and PCB footprint information.
Meets JEDEC moisture sensitivity level 1 requirements.
Plating is 100% matte tin over copper.

Applications Section

Electrical Specifications¹⁴: Freq: 45 - 1000 MHz, T_A = 25°C, V_{DD} = 24 V, Z₀ = 75 Ω

Parameter	Test Conditions	Units	Min.	Typ.	Max.
Gain	45 MHz 1000 MHz	dB	—	27 28	—
Gain Slope	—	dB	—	1	—
Noise Figure	45 MHz 1000 MHz	dB	—	4.5 4.0	—
Reverse Isolation	—	dB	—	38	—
Input Return Loss	45 – 1000 MHz	dB	—	19	—
Output Return Loss	45 – 1000 MHz	dB	—	20	—
P1dB	1000 MHz	dBm	—	26	—
OIP3	1000 MHz, 6 MHz Spacing, +15 dBm P _{OUT} per tone	dBm	—	39	—
OIP2	1000 MHz, 6 MHz Spacing, +15 dBm P _{OUT} per tone	dBm	—	61	—
CTB ¹⁵	79 NTSC V _O = +44 dBmV Flat 79 NTSC + 75 ATSC V _O = +44 dBmV Flat	dBc	—	-73 -72	—
CSO ¹⁵	79 NTSC V _O = +44 dBmV Flat 79 NTSC + 75 ATSC V _O = +44 dBmV Flat	dBc	—	-75 -74	—
XMOD ¹⁵	79 NTSC V _O = +44 dBmV Flat 79 NTSC + 75 ATSC V _O = +44 dBmV Flat	dBc	—	-63 -62	—
CCNR ¹⁵	79 NTSC + 75 ATSC V _O = +44 dBmV Flat	dBc	—	68	—
I _{DD}	+24 Volts	mA	—	265	—

14. See 'Off-Chip Component Values: 45 - 1000 MHz Applications' for the sample board BOM which corresponds to these specifications.

15. Digital channels are -6 dB relative to analog channels.

Off-Chip Component Values: 45 - 1000 MHz Applications

Component	Value	Package	QTY	Vendor	Part Number
C1 - C10	0.01 μ F	0402	10	MURATA	GRM155R71H103KA88D
C11	0.6 pF	0402	1	AVX	ACCU-P 04023J0R6AB
C12	0.4 pF	0402	1	AVX	ACCU-P 04023J0R4AB
C13	0.3 pF	0402	1	AVX	ACCU-P 04023J0R3AB
C14	1.0 pF	0402	1	AVX	ACCU-P 04023J1R0AB
C15, C16	—	0402	0	—	OPEN — NOT USED
C17	—	0402	0	—	OPEN — NOT USED
L1, L2	22 nH	0402	2	COILCRAFT	0402CS-22NXJL
L3, L4	18 nH	0402	2	COILCRAFT	0402CS-18NXJL
L5, L6, L8	6.2 nH	0402	3	COILCRAFT	0402CS-6N2XJL
L7	2 nH	0402	1	COILCRAFT	0402CS-2N0XJL
L9, L10	3.6 nH	0402	2	COILCRAFT	0402CS-3N6XJL
R1, R2, R4 - R7	300 Ω	0402	6	PANASONIC	ERJ-2RKF3000X
R3	2610 Ω	0402	1	PANASONIC	ERJ-2RKF2611X
FB1, FB2	1800 Ω	0402	2	MURATA	BLM15HD182SN1D
T1	1:1	—	1	MACOM	MABA-010321-CT1A42
T2	1:3	—	1	MACOM	MABA-010441-CT38A0

Typical Performance Curves: 45 - 1000 MHz Applications

Gain

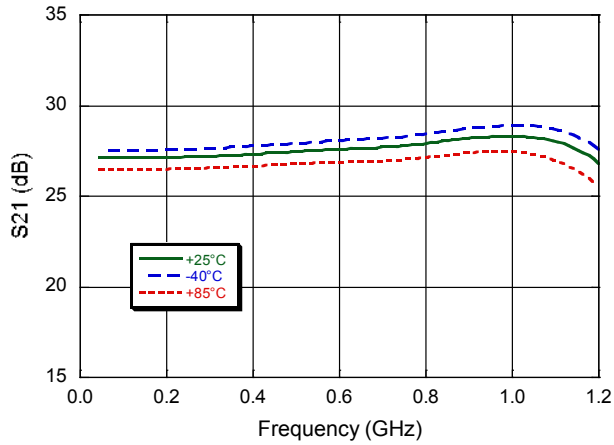

Gain to 2 GHz

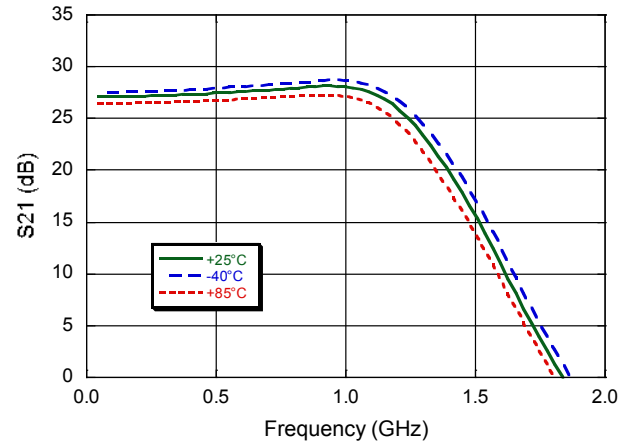

Input Return Loss

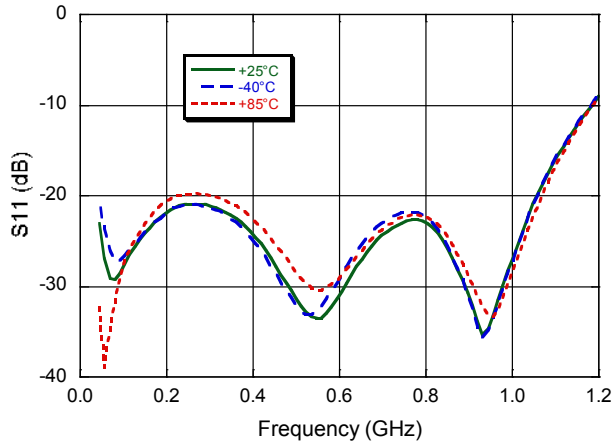

Output Return Loss

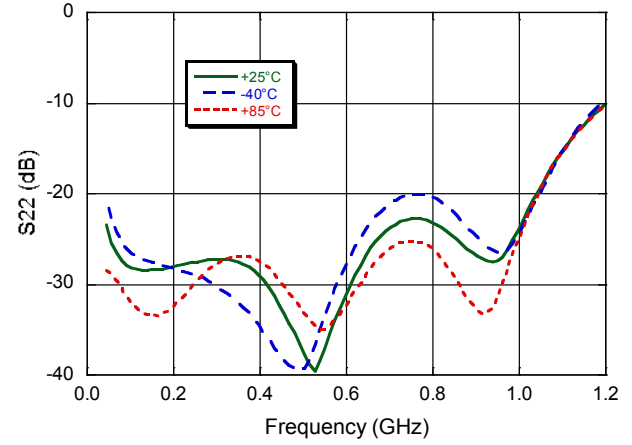

Reverse Isolation

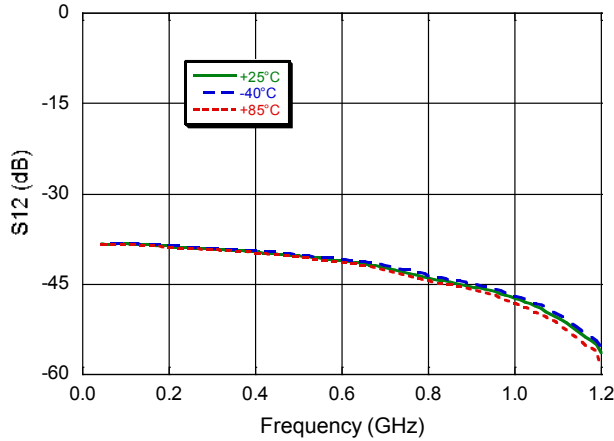

Noise Figure

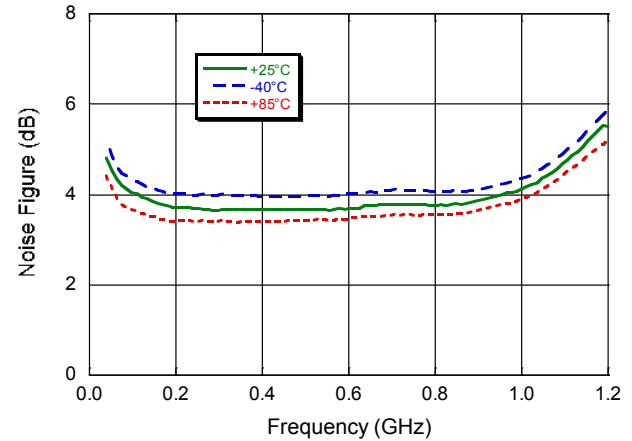

Typical Distortion Performance Curves: 79 NTSC $V_0 = +44$ dBmV Flat @ +25°C

CTB

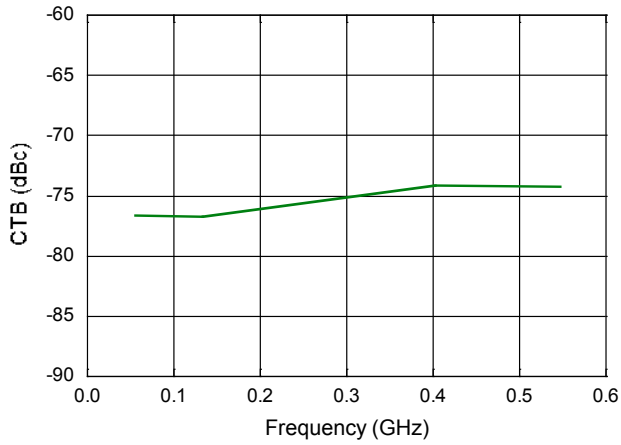

XMOD

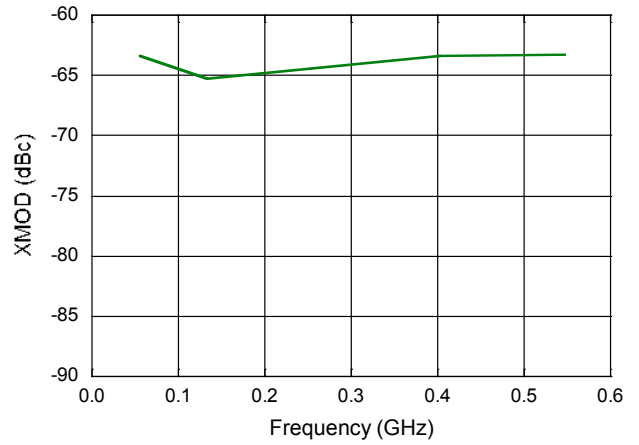

CSOL

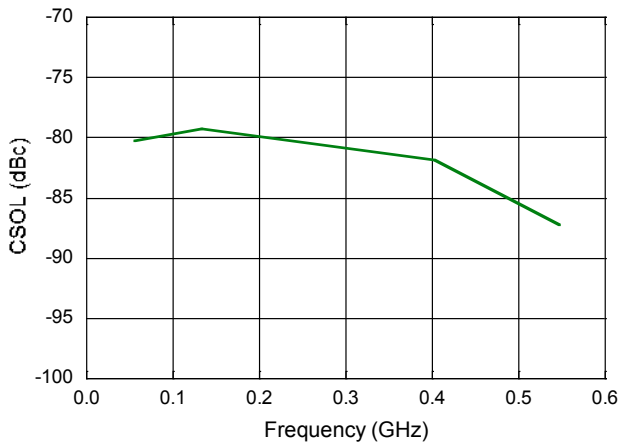

CSOH

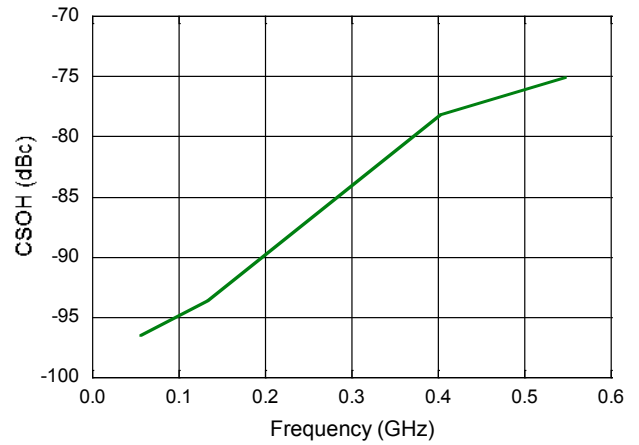

Typical Distortion Performance Curves: 79 NTSC + 75 ATSC $V_0 = +44$ dBmV Flat @ +25°C

CTB

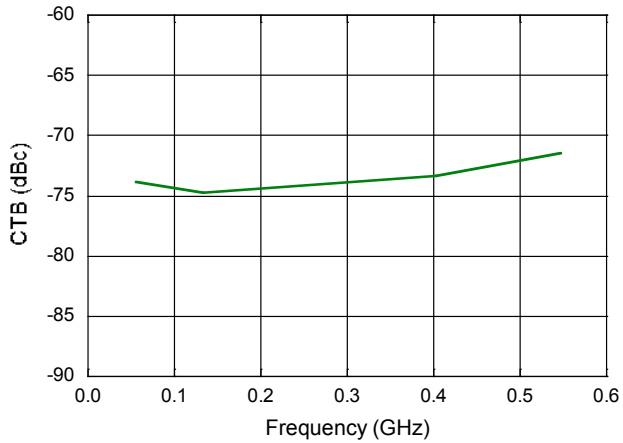

XMOD

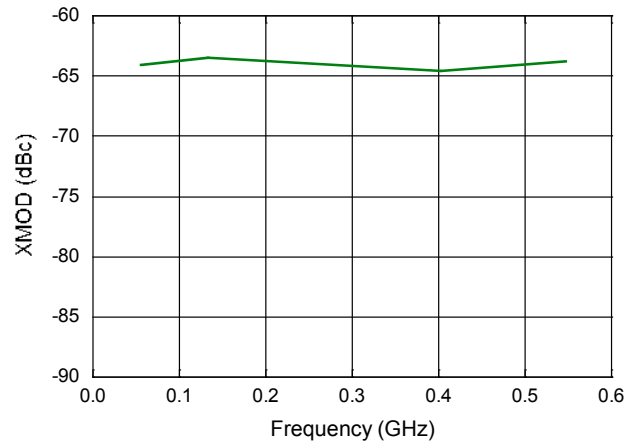

CSOL

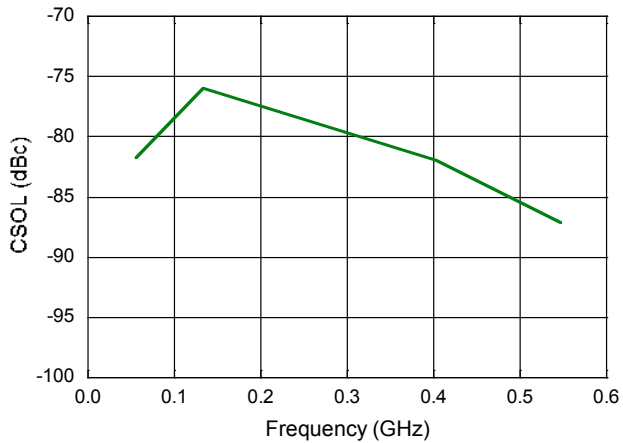

CSOH

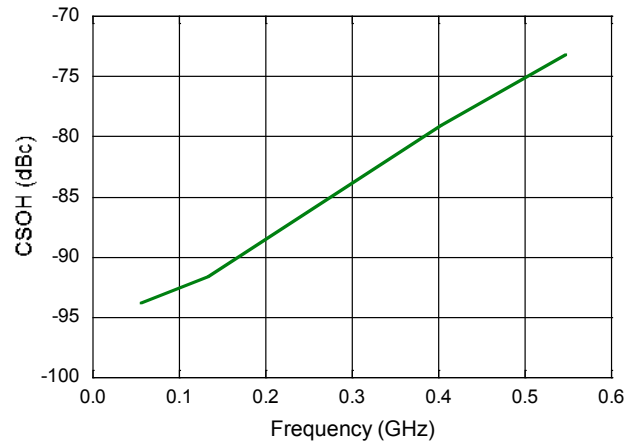

CCNR

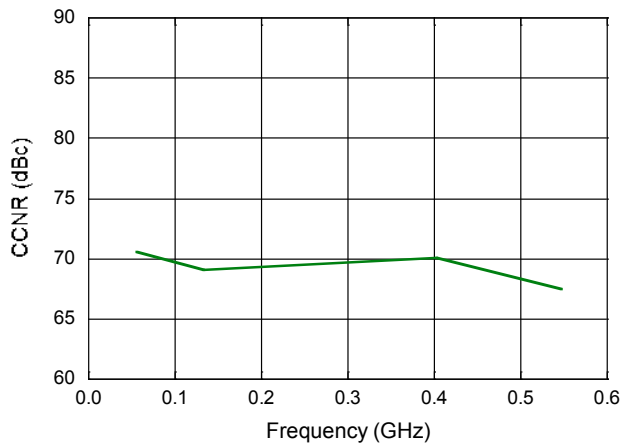

M/A-COM Technology Solutions Inc. All rights reserved.

Information in this document is provided in connection with M/A-COM Technology Solutions Inc ("MACOM") products. These materials are provided by MACOM as a service to its customers and may be used for informational purposes only. Except as provided in MACOM's Terms and Conditions of Sale for such products or in any separate agreement related to this document, MACOM assumes no liability whatsoever. MACOM assumes no responsibility for errors or omissions in these materials. MACOM may make changes to specifications and product descriptions at any time, without notice. MACOM makes no commitment to update the information and shall have no responsibility whatsoever for conflicts or incompatibilities arising from future changes to its specifications and product descriptions. No license, express or implied, by estoppel or otherwise, to any intellectual property rights is granted by this document.

THESE MATERIALS ARE PROVIDED "AS IS" WITHOUT WARRANTY OF ANY KIND, EITHER EXPRESS OR IMPLIED, RELATING TO SALE AND/OR USE OF MACOM PRODUCTS INCLUDING LIABILITY OR WARRANTIES RELATING TO FITNESS FOR A PARTICULAR PURPOSE, CONSEQUENTIAL OR INCIDENTAL DAMAGES, MERCHANTABILITY, OR INFRINGEMENT OF ANY PATENT, COPYRIGHT OR OTHER INTELLECTUAL PROPERTY RIGHT. MACOM FURTHER DOES NOT WARRANT THE ACCURACY OR COMPLETENESS OF THE INFORMATION, TEXT, GRAPHICS OR OTHER ITEMS CONTAINED WITHIN THESE MATERIALS. MACOM SHALL NOT BE LIABLE FOR ANY SPECIAL, INDIRECT, INCIDENTAL, OR CONSEQUENTIAL DAMAGES, INCLUDING WITHOUT LIMITATION, LOST REVENUES OR LOST PROFITS, WHICH MAY RESULT FROM THE USE OF THESE MATERIALS.

MACOM products are not intended for use in medical, lifesaving or life sustaining applications. MACOM customers using or selling MACOM products for use in such applications do so at their own risk and agree to fully indemnify MACOM for any damages resulting from such improper use or sale.