

# Digital Step Attenuator

75Ω DC-2000 MHz

31.5 dB, 0.5 dB Step

6 Bit, Serial Control Interface, Dual Supply Voltage

## Product Features

- Dual Supply Voltage:  $V_{DD}=+3V$ ,  $V_{SS}=-3V$
- Immune to latch up
- Excellent accuracy, 0.1 dB Typ
- Serial control interface
- Fast Switching control frequency, 1 MHz Typ
- Low Insertion Loss
- High IP3, +52 dBm Typ
- Very low DC power consumption
- Excellent return loss, 20 dB Typ
- Small size 4.0 x 4.0 mm

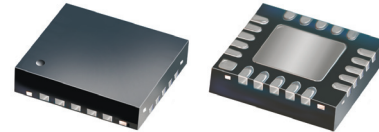

## DAT-31575-SN+

CASE STYLE: DG983-1  
PRICE: \$3.80 ea. QTY. (20)

## Typical Applications

- Base Station Infrastructure
- Portable Wireless
- CATV & DBS
- MMDS & Wireless LAN
- Wireless Local Loop
- UNII & Hiper LAN
- Power amplifier distortion canceling loops

### +RoHS Compliant

The +Suffix identifies RoHS Compliance. See our web site for RoHS Compliance methodologies and qualifications

## General Description

The DAT-31575-SN+ is a 75Ω RF digital step attenuator that offers an attenuation range up to 31.5 dB in 0.5 dB steps. The control is a 6-bit serial interface, operating on dual supply voltage:  $V_{DD}=+3V$ ,  $V_{SS}=-3V$ . The DAT-31575-SN+ is produced using a unique CMOS process on silicon, offering the performance of GaAs, with the advantages of conventional CMOS devices.

## Simplified Schematic

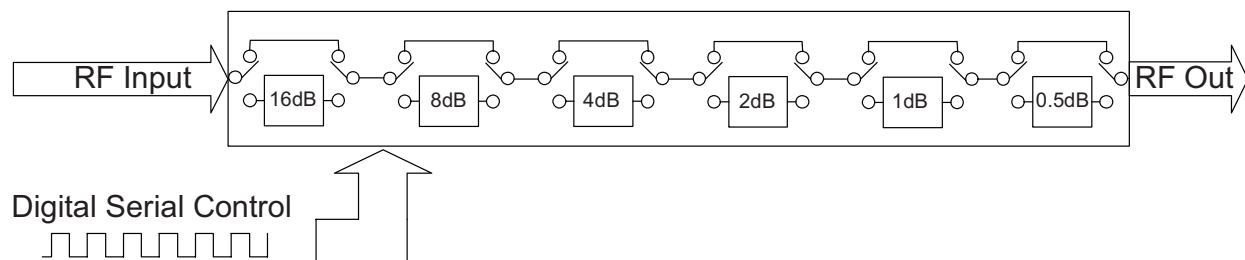

**Mini-Circuits**  
ISO 9001 ISO 14001 AS 9100 CERTIFIED  
IF/RF MICROWAVE COMPONENTS

For detailed performance specs  
& shopping online see web site

P.O. Box 350166, Brooklyn, New York 11235-0003 (718) 934-4500 Fax (718) 332-4661 The Design Engineers Search Engine Provides ACTUAL Data Instantly at [minicircuits.com](http://minicircuits.com)

Notes: 1. Performance and quality attributes and conditions not expressly stated in this specification sheet are intended to be excluded and do not form a part of this specification sheet. 2. Electrical specifications and performance data contained herein are based on Mini-Circuit's applicable established test performance criteria and measurement instructions. 3. The parts covered by this specification sheet are subject to Mini-Circuits standard limited warranty and terms and conditions (collectively, "Standard Terms"); Purchasers of this part are entitled to the rights and benefits contained therein. For a full statement of the Standard Terms and the exclusive rights and remedies thereunder, please visit Mini-Circuits' website at [www.minicircuits.com/MCLStore/terms.jsp](http://www.minicircuits.com/MCLStore/terms.jsp).

REV. H  
M133118  
DAT-31575-SN+  
120624  
Page 1 of 12

# Digital Step Attenuator

# DAT-31575-SN+

**RF Electrical Specifications, DC-2000 MHz, T<sub>AMB</sub>=25°C, V<sub>DD</sub>=+3V, V<sub>SS</sub>=-3V**

Parameter	Freq. Range (GHz)	Min.	Typ.	Max.	Units
Accuracy @ 0.5 dB Attenuation Setting	DC-1.2	—	0.03	0.17	dB
	1.2-2.0	—	0.05	0.18	dB
Accuracy @ 1 dB Attenuation Setting	DC-1.2	—	0.03	0.24	dB
	1.2-2.0	—	0.1	0.25	dB
Accuracy @ 2 dB Attenuation Setting	DC-1.2	—	0.07	0.28	dB
	1.2-2.0	—	0.15	0.3	dB
Accuracy @ 4 dB Attenuation Setting	DC-1.2	—	0.05	0.36	dB
	1.2-2.0	—	0.15	0.4	dB
Accuracy @ 8 dB Attenuation Setting	DC-1.2	—	0.1	0.52	dB
	1.2-2.0	—	0.24	0.6	dB
Accuracy @ 16 dB Attenuation Setting	DC-1.2	—	0.23	0.84	dB
	1.2-2.0	—	0.8	1.0	dB
Insertion Loss <sup>(note1)</sup> @ all attenuator set to 0dB	DC-1.2	—	1.2	1.8	dB
	1.2-2.0	—	1.6	2.1	dB
Input IP3 <sup>(note2)</sup> (at Min. and Max. Attenuation)	DC-2.0	—	+52	—	dBm
Input Power @ 0.2dB Compression <sup>(note2)</sup> (at Min. and Max. Attenuation)	DC-2.0	—	+24	—	dBm
VSWR	DC-1.2	—	1.6	2.0	—
	1.2-2.0	—	1.7	2.0	—

## DC Electrical Specifications

Parameter	Min.	Typ.	Max.	Units
V <sub>DD</sub> , Supply Voltage	2.7	3	3.3	V
V <sub>SS</sub> , Supply Voltage	-3.3	-3	-2.7	V
I <sub>DD</sub> (I <sub>SS</sub> ), Supply Current, quiescent <sup>(note 3)</sup>	—	—	100	μA
Control Input Low	—	—	0.3xV <sub>DD</sub>	V
Control Input High	0.7xV <sub>DD</sub>	—	—	V
Control Current	—	—	1	μA

### Notes:

1. Loss values are de-embedded from test board Loss (test board's Insertion Loss: 0.10dB @100MHz, 0.40dB @1200MHz, 0.55dB @2000MHz, 0.75dB @4000MHz).
2. Input IP3 and 1dB compression degrades below 1 MHz.
3. During turn-on and transition between attenuation states, device may draw up to 2mA.

## Switching Specifications

Parameter	Min.	Typ.	Max.	Units
Switching Speed, 50% Control to 0.5dB of Attenuation Value	—	1.0	—	μSec
Switching Control Frequency	—	1.0	—	MHz

## Absolute Maximum Ratings

Parameter	Ratings
Operating Temperature	-40°C to 85°C
Storage Temperature	-55°C to 100°C
V <sub>DD</sub>	-0.3V Min., 4V Max.
V <sub>SS</sub>	-4V Min., 0.3V Max.
Voltage on any input	-0.3V Min., V <sub>DD</sub> +0.3V Max.
ESD, HBM	500V
ESD, MM	100V
Input Power	+24dBm

Permanent damage may occur if any of these limits are exceeded.



For detailed performance specs & shopping online see web site

P.O. Box 350166, Brooklyn, New York 11235-0003 (718) 934-4500 Fax (718) 332-4661 The Design Engineers Search Engine Provides ACTUAL Data Instantly at [minicircuits.com](http://minicircuits.com)

Notes: 1. Performance and quality attributes and conditions not expressly stated in this specification sheet are intended to be excluded and do not form a part of this specification sheet. 2. Electrical specifications and performance data contained herein are based on Mini-Circuit's applicable established test performance criteria and measurement instructions. 3. The parts covered by this specification sheet are subject to Mini-Circuits standard limited warranty and terms and conditions (collectively, "Standard Terms"); Purchasers of this part are entitled to the rights and benefits contained therein. For a full statement of the Standard Terms and the exclusive rights and remedies thereunder, please visit Mini-Circuits' website at [www.minicircuits.com/MCLStore/terms.jsp](http://www.minicircuits.com/MCLStore/terms.jsp).

## Pin Description

Function	Pin Number	Description
C16	1	Control for Attenuation bit, 16dB (Notes 3,4)
RF in	2	RF in port (Note 1)
Data	3	Serial Interface data input (Note 3)
Clock	4	Serial Interface clock input
LE	5	Latch Enable Input (Note 2)
V <sub>DD</sub>	6	Positive Supply Voltage
N/C	7	Not connected
N/C	8	Not connected
V <sub>DD</sub>	9	Positive Supply Voltage
GND	10	Ground connection
GND	11	Ground connection
V <sub>SS</sub>	12	Negative Supply Voltage
V <sub>DD</sub>	13	Positive Supply Voltage
RF out	14	RF out port (Note 1)
C8	15	Control for attenuation bit, 8 dB (Note 4)
C4	16	Control for attenuation bit, 4 dB (Note 4)
C2	17	Control for attenuation bit, 2 dB (Note 4)
GND	18	Ground Connection
C1	19	Control for attenuation bit, 1 dB (Note 4)
C0.5	20	Control for attenuation bit, 0.5 dB (Note 4)
GND	Paddle	Paddle ground (Note 5)

## Pin Configuration (Top View)

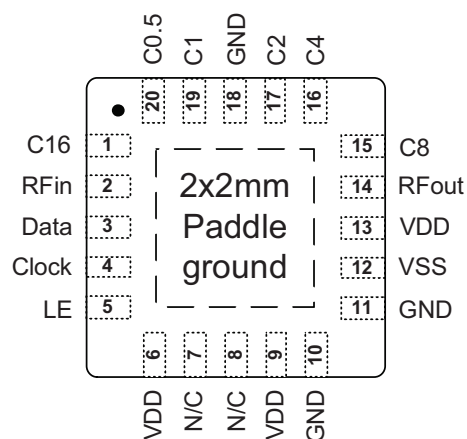

### Notes:

- Both RF ports must be held at 0VDC or DC blocked with an external series capacitor.
- Latch Enable (LE) has an internal 100KΩ resistor to V<sub>DD</sub>.
- Place a 10KΩ resistor in series, as close to pin as possible to avoid freq. resonance.
- Refer to Power-up Control Settings.
- The exposed solder pad on the bottom of the package (See Pin configuration) must be grounded for proper device operation.

## Typical Performance Curves

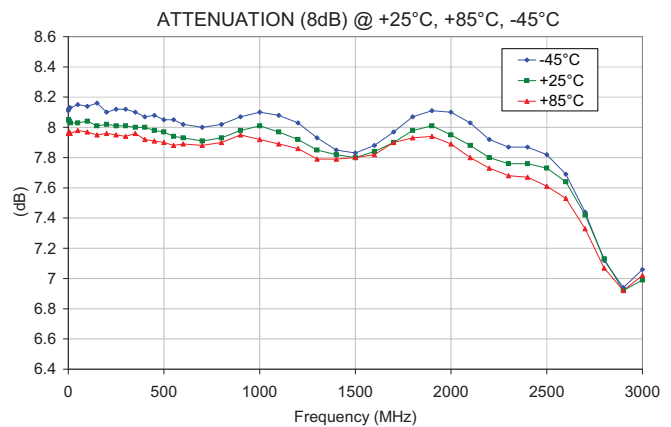
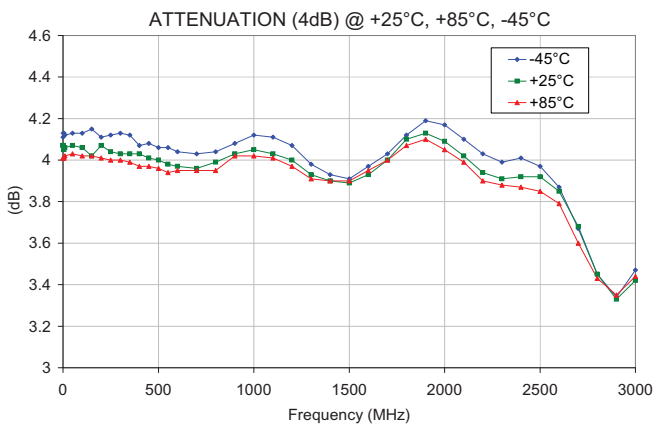
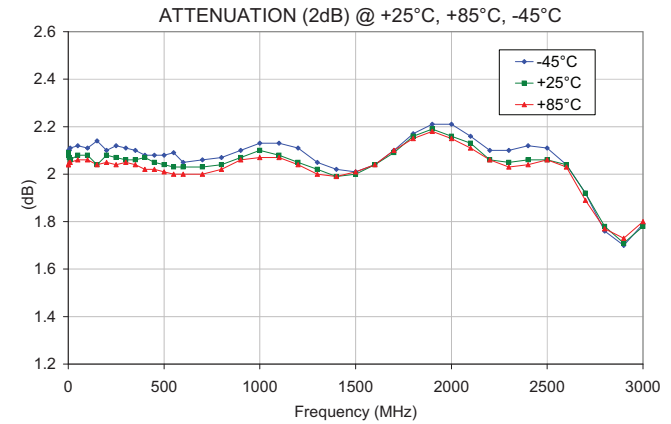
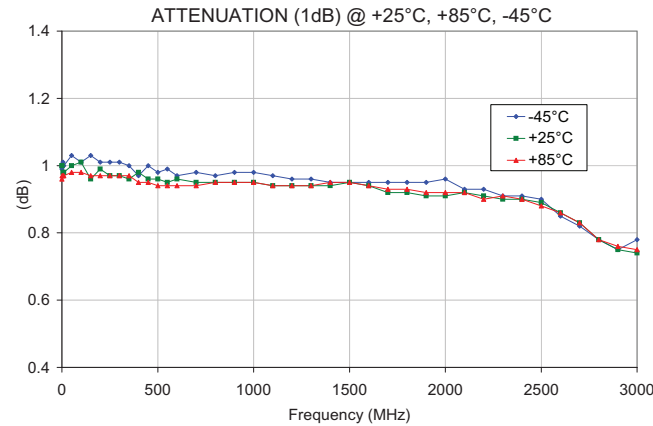
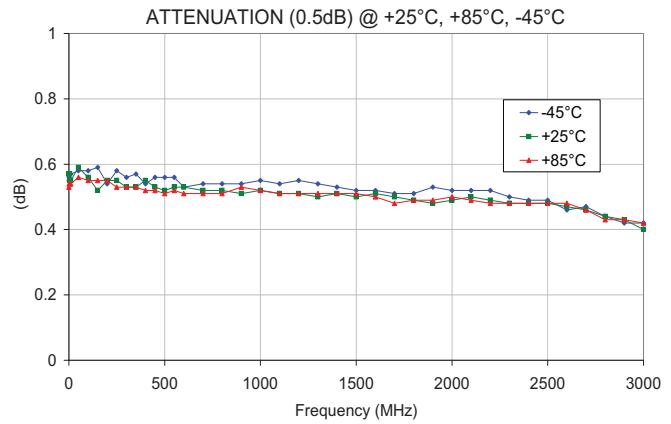
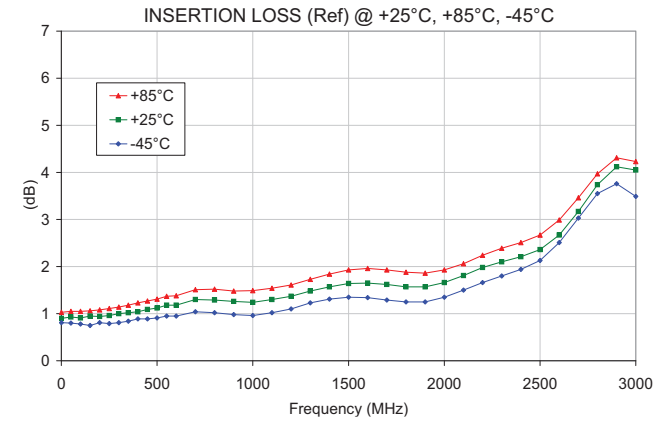

## Typical Performance Curves

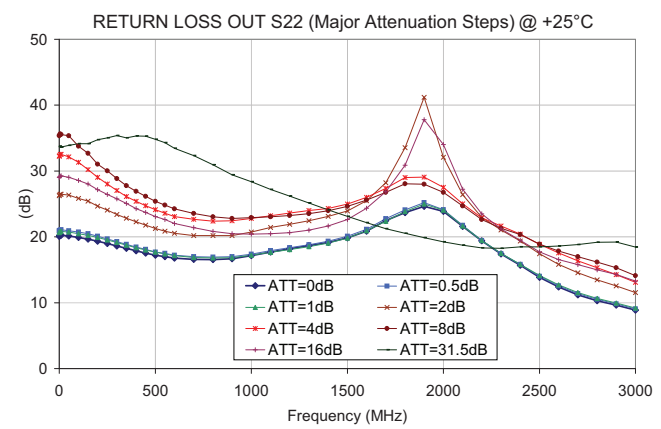
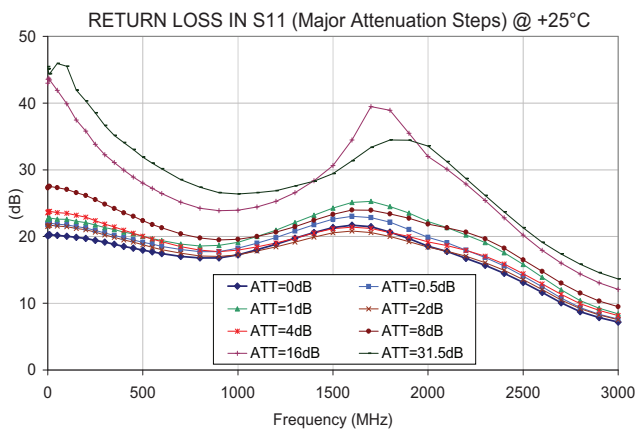
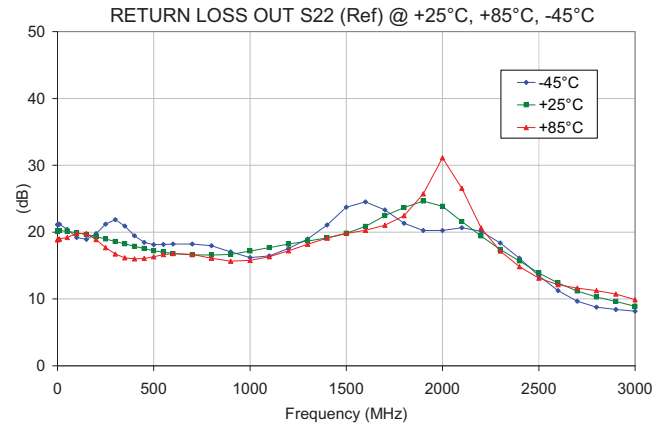
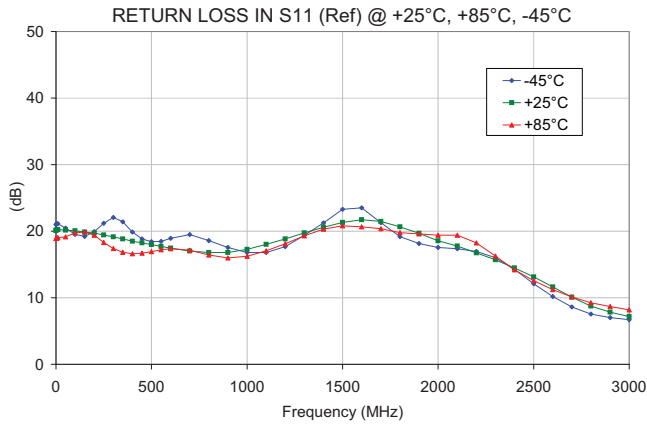
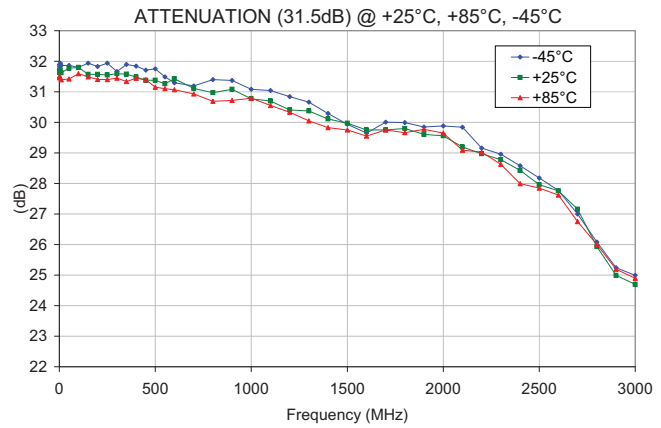
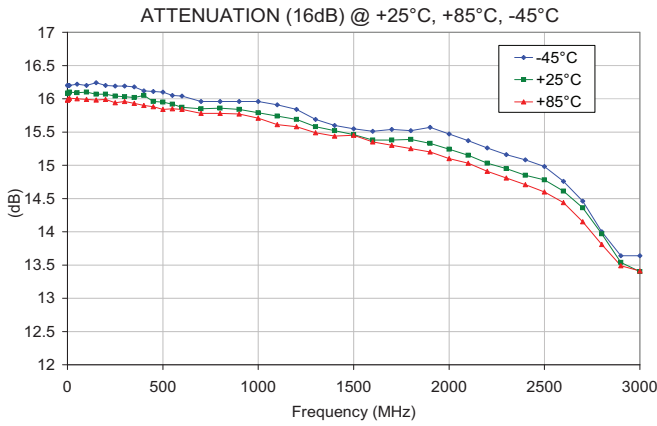

## Typical Performance Curves

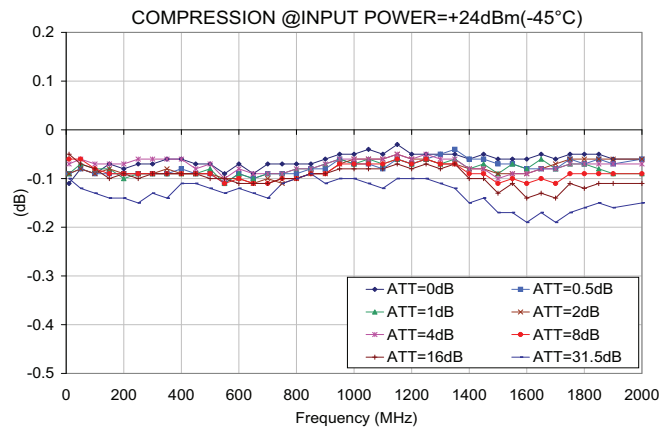
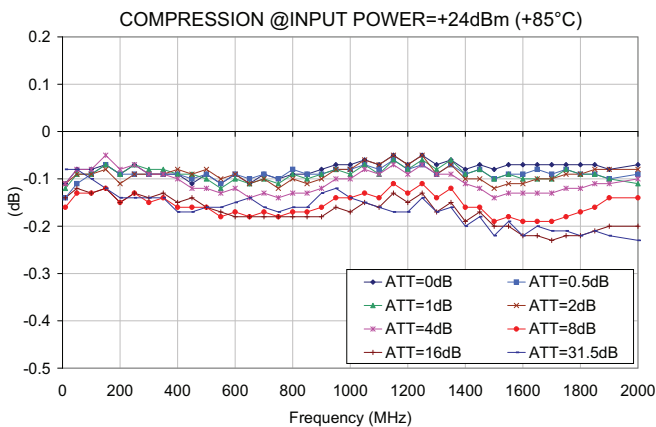
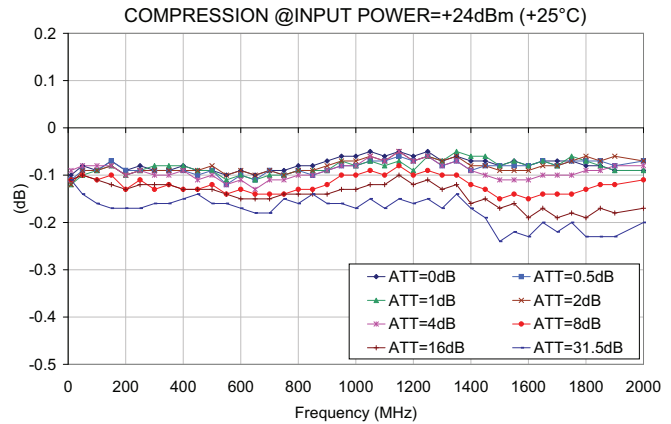
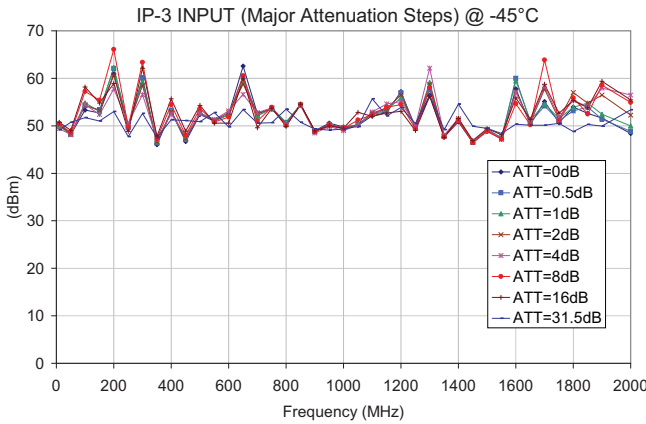
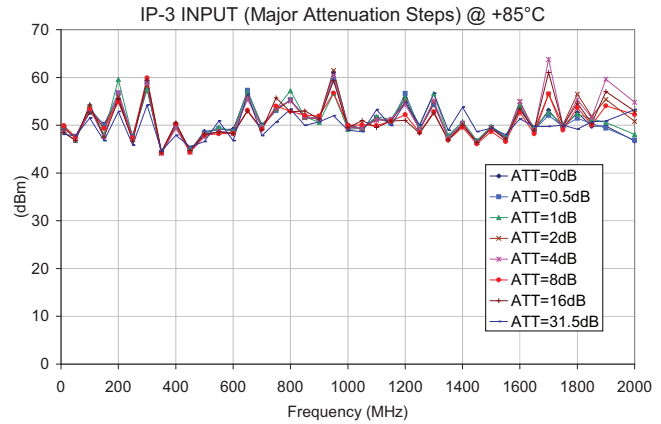
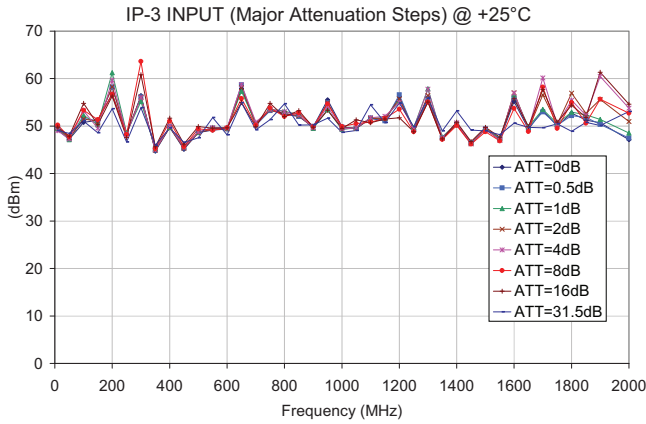

## Outline Drawing (DG983-1)

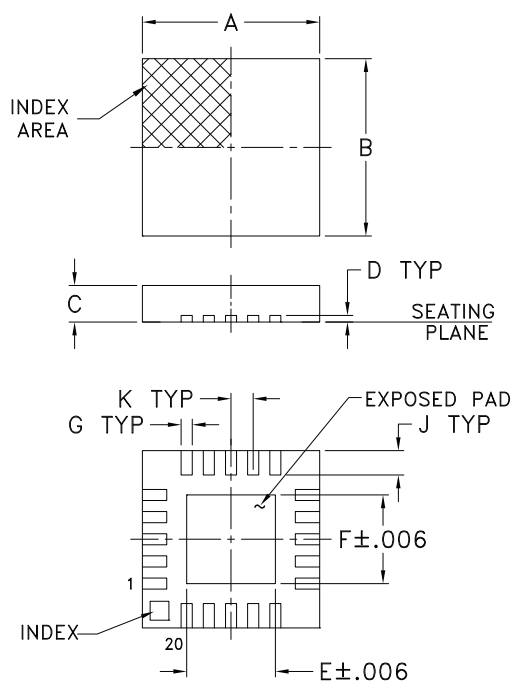

## PCB Land Pattern

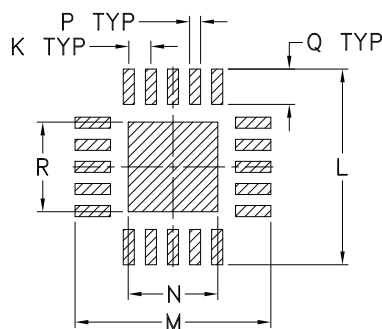

Suggested Layout,  
Tolerance to be within ±.002

## Device Marking

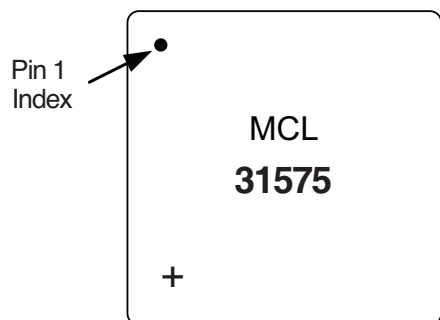

## Outline Dimensions (inch/mm)

A	B	C	D	E	F	G	H	J	K	L	M	N	P	Q	R	WT. GRAMS
.157	.157	.035	.008	.081	.081	.010	—	.022	.020	.177	.177	.081	.010	.032	.081	.04
4.00	4.00	0.90	0.20	2.06	2.06	0.25	—	0.56	0.50	4.50	4.50	2.06	0.25	0.81	2.06	

## Suggested Layout for PCB Design (PL-185)

The suggested Layout shows only the footprint area of the DAT, and the components located near this area (i.e.: R1-R7). For the complete Layout, see photo and schematic diagram on page 11 of 12.

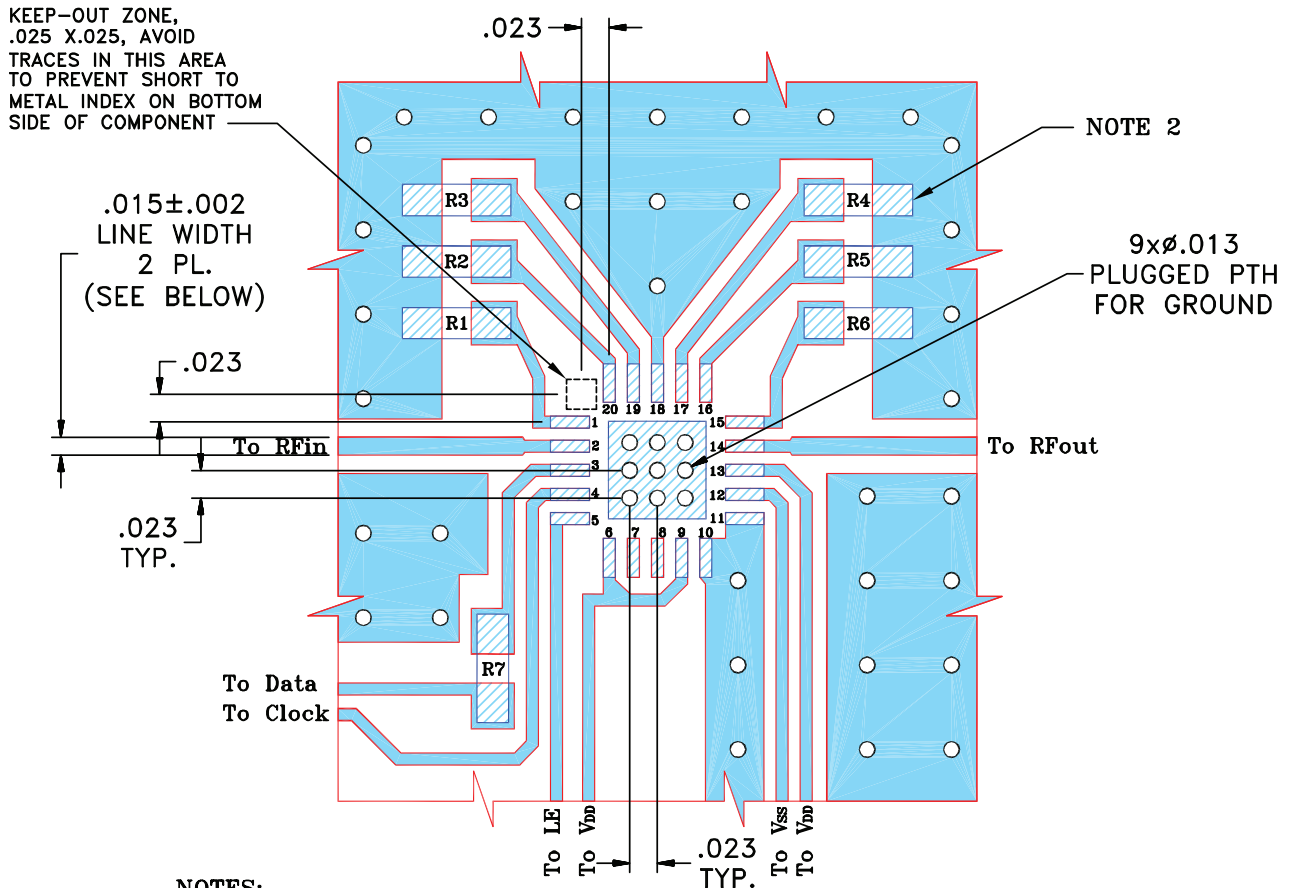

### NOTES:

1. TRACE WIDTH IS SHOWN FOR FR4 WITH DIELECTRIC THICKNESS .025"±.002". COPPER: 1/2 OZ. EACH SIDE. FOR OTHER MATERIALS TRACE WIDTH MAY NEED TO BE MODIFIED.
2. 0603 SIZE CHIP FOOT PRINTS SHOWN FOR REFERENCE, VALUES OF RESISTORS WILL VARY BASED ON APPLICATION.
3. BOTTOM SIDE OF THE PCB IS CONTINUOUS GROUND PLANE.



DENOTES PCB COPPER LAYOUT WITH SMOBC (SOLDER MASK OVER BARE COPPER)



DENOTES COPPER LAND PATTERN FREE OF SOLDER MASK



## Simplified Schematic

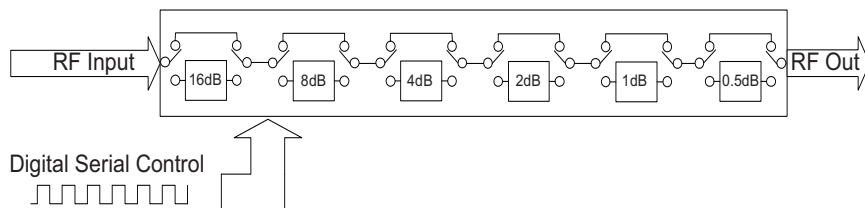

The DAT-31575-SN+ serial interface consists of 6 control bits that select the desired attenuation state, as shown in **Table 1: Truth Table**

Table 1. Truth Table						
Attenuation State	C16	C8	C4	C2	C1	C0.5
Reference	0	0	0	0	0	0
0.5 (dB)	0	0	0	0	0	1
1 (dB)	0	0	0	0	1	0
2 (dB)	0	0	0	1	0	0
4 (dB)	0	0	1	0	0	0
8 (dB)	0	1	0	0	0	0
16 (dB)	1	0	0	0	0	0
31.5 (dB)	1	1	1	1	1	1

Note: Not all 64 possible combinations of C0.5 - C16 are shown in table

The serial interface is a 6-bit serial in, parallel-out shift register buffered by a transparent latch.

It is controlled by three CMOS-compatible signals: Data, Clock, and Latch Enable (LE). The Data and Clock inputs allow data to be serially entered into the shift register, a process that is independent of the state of the LE input.

The LE input controls the latch. When LE is HIGH, the latch is transparent and the contents of the serial shift register control the attenuator. When LE is brought LOW, data in the shift register is latched.

The shift register should be loaded while LE is held LOW to prevent the attenuator value from changing as data is entered. The LE input should then be toggled HIGH and brought LOW again, latching the new data. The timing for this operation is defined by **Figure 1** (Serial Interface Timing Diagram) and **Table 2** (Serial Interface AC Characteristics).

**Figure 1: Serial Interface Timing Diagram**

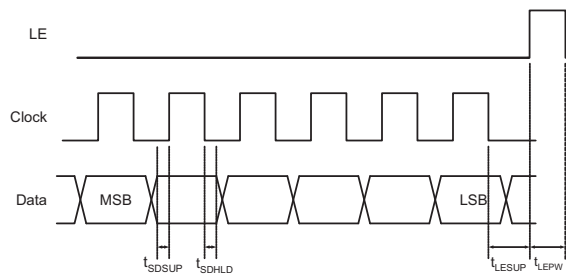

Table 2. Serial Interface AC Characteristics				
Symbol	Parameter	Min.	Max.	Units
$f_{clk}$	Serial data clock frequency (Note 1)		10	MHz
$t_{clkH}$	Serial clock HIGH time	30		ns
$t_{clkL}$	Serial clock LOW time	30		ns
$t_{LESUP}$	LE set-up time after last clock falling edge	10		ns
$t_{LEPW}$	LE minimum pulse width	30		ns
$t_{SDSUP}$	Serial data set-up time before clock rising edge	10		ns
$t_{SDHLD}$	Serial data hold time after clock falling edge	10		ns

Note 1. fclk verified during the functional pattern test. Serial programming sections of the functional pattern are clocked at 10MHz to verify fclk specification.

The DAT-31575-SN+, uses a common 6-bit serial word format, as shown in **Table 3**: 6-Bit attenuator Serial Programming Register Map.

The first bit, the MSB, corresponds to the 16 dB Step and the last bit, the LSB, corresponds to the 0.5 dB step.

**Table 3. 6-Bit attenuator Serial Programming Register Map**

B5	B4	B3	B2	B1	B0
C16	C8	C4	C2	C1	C0.5

↑
↑  
 MSB (first in)
 LSB (last in)

### Power-up Control Settings

The DAT-31575-SN+ always assumes a specifiable attenuation setting on power-up, allowing a known attenuation state to be established before an initial serial control word is provided.

When the attenuator powers up, the six control bits are set to whatever data is present on the six data inputs (C0.5 to C16).

This allows any one of the 64 attenuation settings to be specified as the power-up state.

## TB-343 Evaluation Board Schematic Diagram

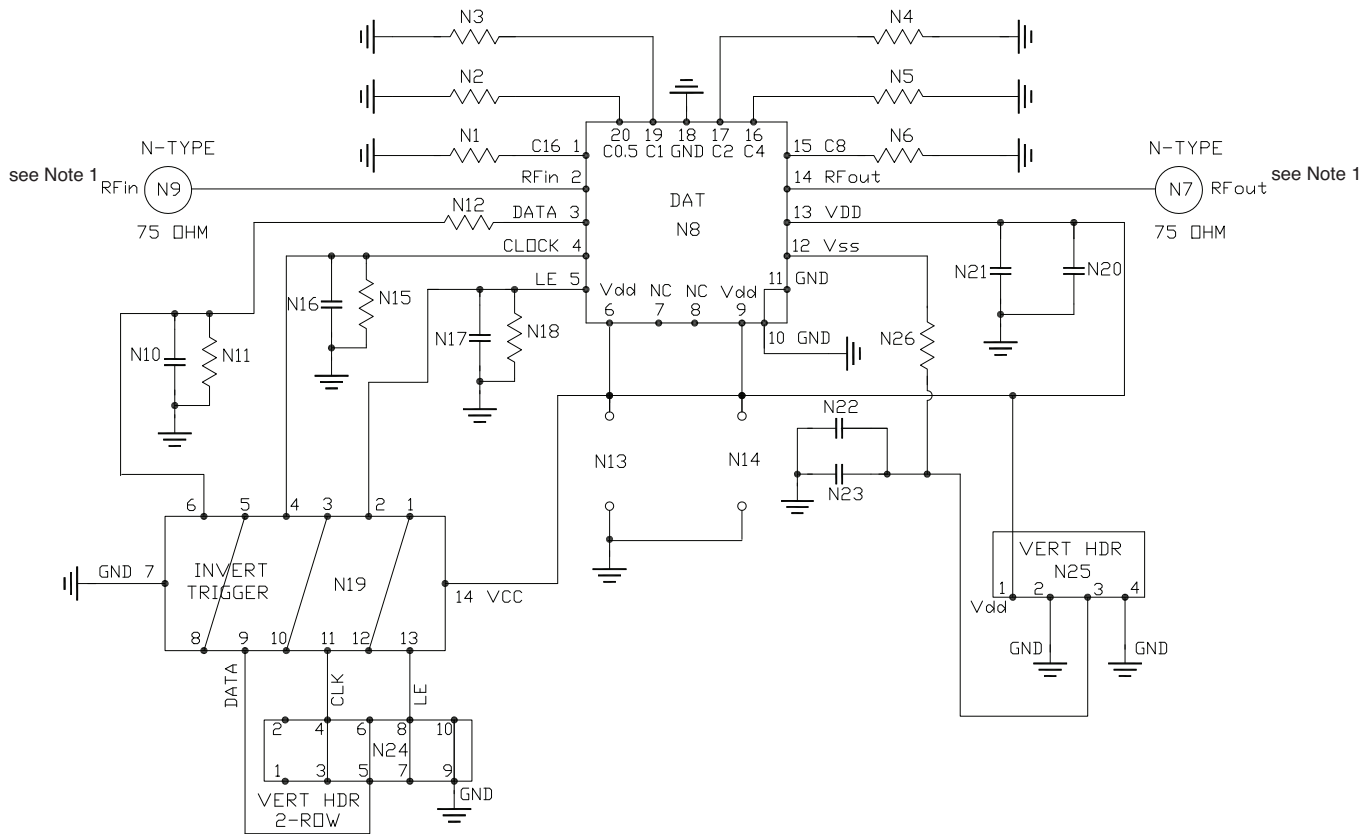

Note 1: Both RF ports must be held at 0VDC or DC blocked with an external series capacitor.

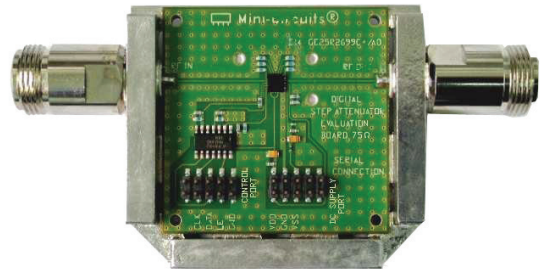

**TB-343**

Bill of Materials	
N1-N6, N11, N12, N15 & N18	Resistor 0603 10 KOhm +/- 1%
N26	Resistor 0603 0 Ohm
N10, N16, N17, N20 & N23	NPO Capacitor 0603 100pF +/- 5%
N21 & N22	Tantalum Capacitor 0805 100nF +/- 10%
N19	Hex Invert Schmitt Trigger MSL1



P.O. Box 350166, Brooklyn, New York 11235-0003 (718) 934-4500 Fax (718) 332-4661 The Design Engineers Search Engine Provides ACTUAL Data Instantly at [minicircuits.com](http://minicircuits.com) IF/RF MICROWAVE COMPONENTS

For detailed performance specs & shopping online see web site

Notes: 1. Performance and quality attributes and conditions not expressly stated in this specification sheet are intended to be excluded and do not form a part of this specification sheet. 2. Electrical specifications and performance data contained herein are based on Mini-Circuits' applicable established test performance criteria and measurement instructions. 3. The parts covered by this specification sheet are subject to Mini-Circuits standard limited warranty and terms and conditions (collectively, "Standard Terms"); Purchasers of this part are entitled to the rights and benefits contained therein. For a full statement of the Standard Terms and the exclusive rights and remedies thereunder, please visit Mini-Circuits' website at [www.minicircuits.com/MCLStore/terms.jsp](http://www.minicircuits.com/MCLStore/terms.jsp). Page 11 of 12

## Tape and Reel Packaging Information

Table T&R

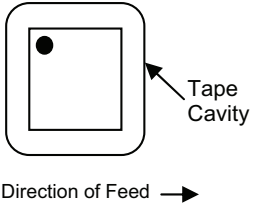
TR No.	No. of Devices	Reel Size	Tape Width	Pitch	Unit Orientation
F87	Small quantity standards 20, 50, 100, 200	7 inch	12 mm	8 mm	
	3000 (Standard)	13 inch			