

Features:

- Octave bandwidth, specification from 10~1500MHz, usable from 10~2000MHz
- Low noise figure, and high gain
- Low VSWR, unconditional stable
- Small size, low cost
- SMA female connector I/O
- Single DC power supply, internal voltage regulator, operating voltage from +12~+15V
- Operating temperature -40~+75°C, storage temperature -55~+125°C

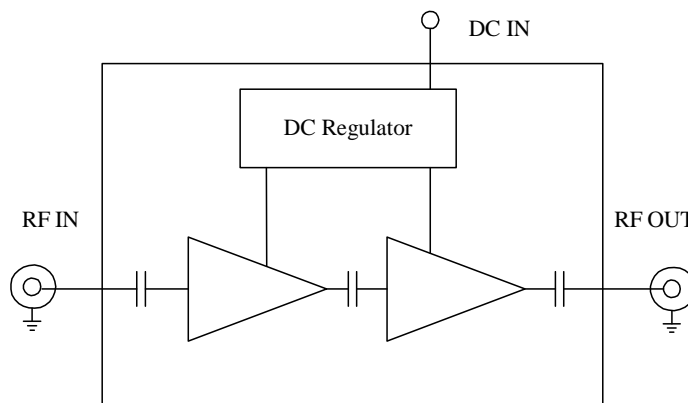

Functional Diagram



Electrical Specifications

Frequency Range	10 MHz		1500 MHz
Noise Figure (from 30MHz)		2.0dB	2.5dB
P-1dB Compression Point	+10dBm	+11dBm	
Nominal Gain @25°C	28 dB	30 dB	32 dB
Gain flatness			+/-1.0 dB
Gain Variation		+/-1.0 dB	
Input VSWR			1.5:1
Output VSWR			2.0:1
Reverse Isolation	50dB.		
Non-Harmonic Spurious			-60 dBc
Operating Temperature	-40°C		+75°C
Survival Temperature	-55°C		+125°C
DC Power Supply Voltage	+10V	+12V	+15V
DC Power Supply Current	80 mA	90mA	100mA
In/Out connectors	SMA female		
Size	1.5"x0.85"x0.375		

Mechanical Structure:

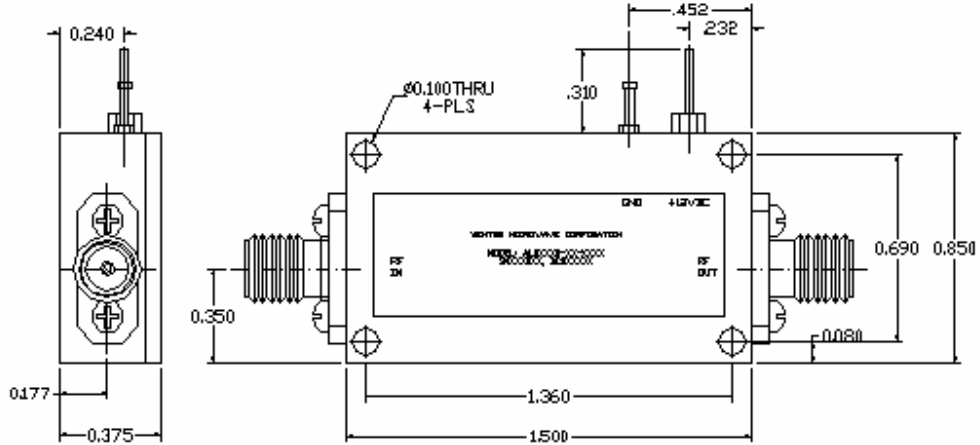

Note: All units in inches.

Typical Test Results:

ABL0150-01-3025 Measured Gain and Return Loss vs Frequency

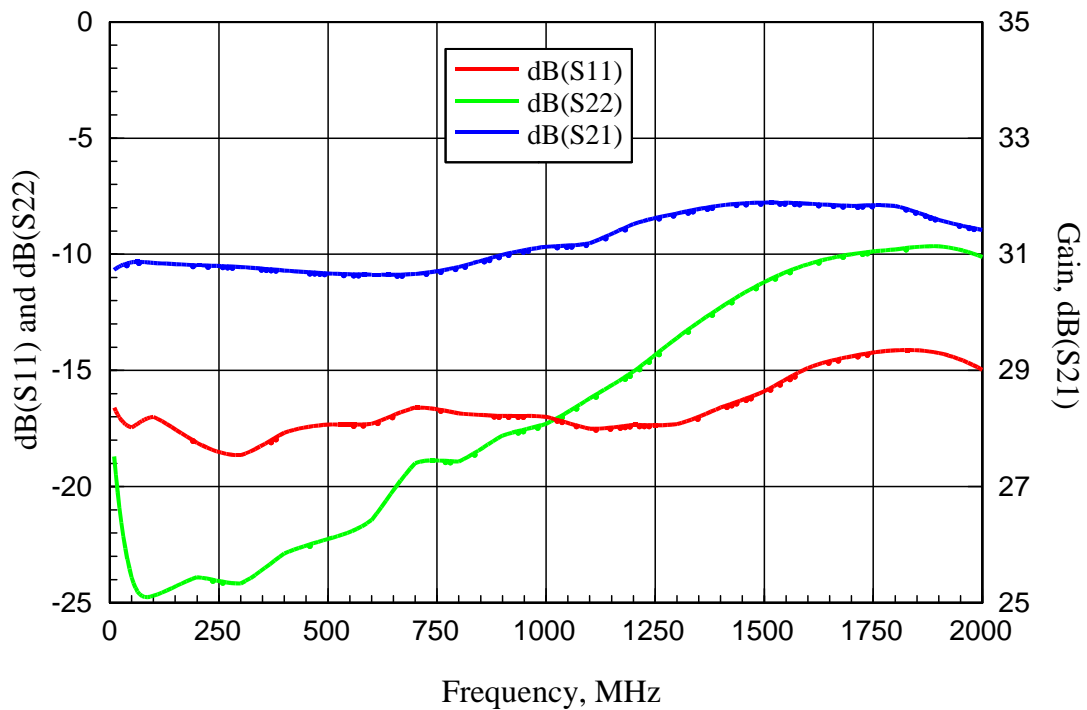

ABL0150-01-3025 Measured Noise Figure vs Frequency

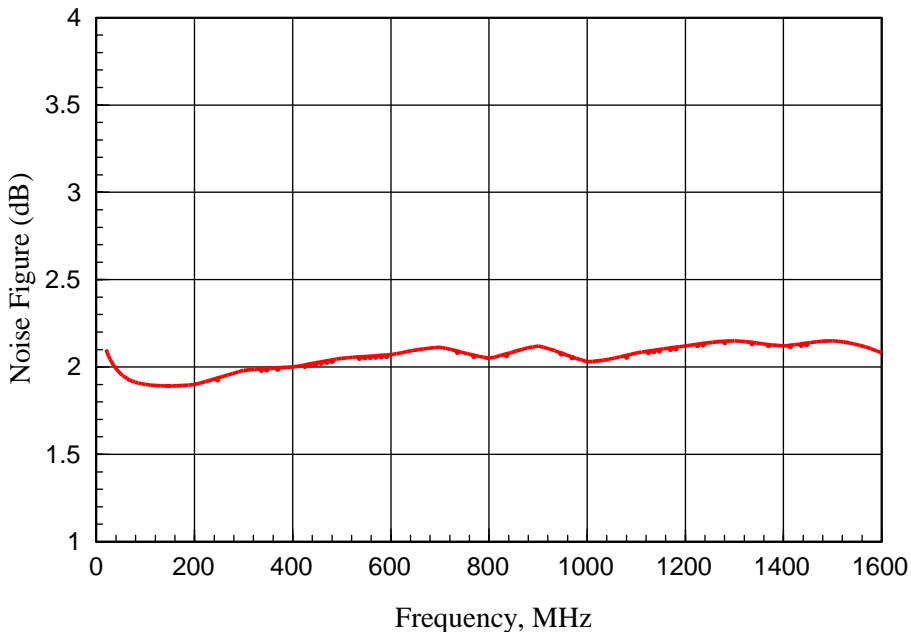

ABL0150-01-3025 Measured Gain and Output Power vs Input Power
Test Frequency: 100MHz

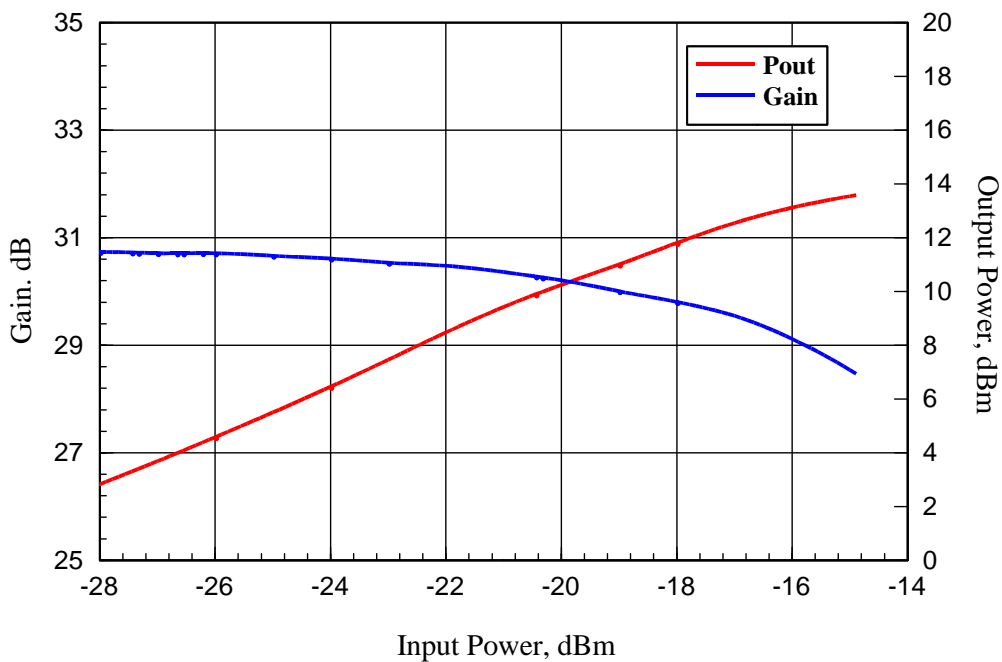

ABL0150-01-3025 Measured Gain and Output Power vs Input Power
Test Frequency: 750MHz

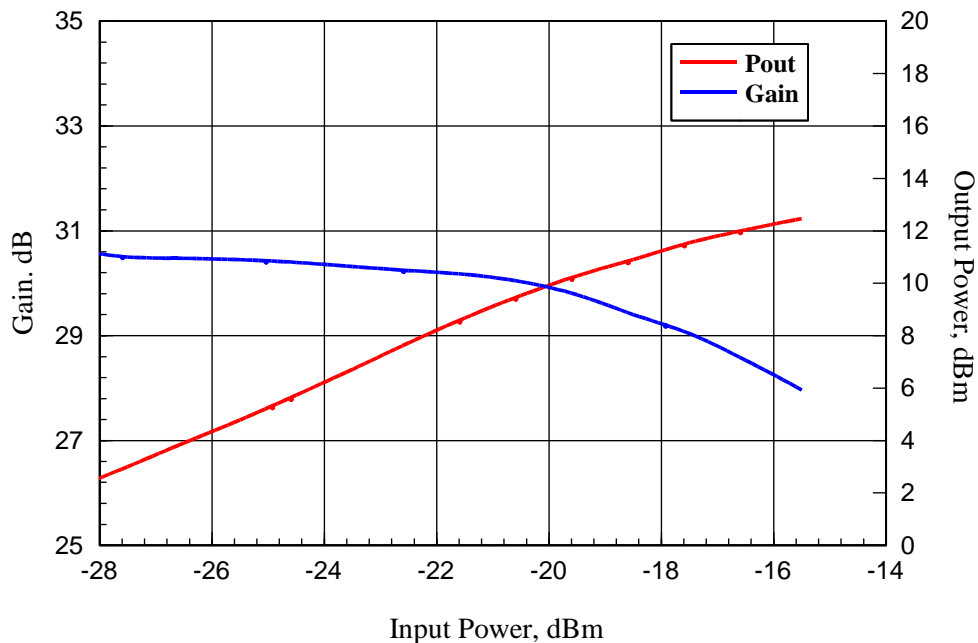

ABL0150-01-3025 Measured Gain and Output Power vs Input Power
Test Frequency: 1500MHz

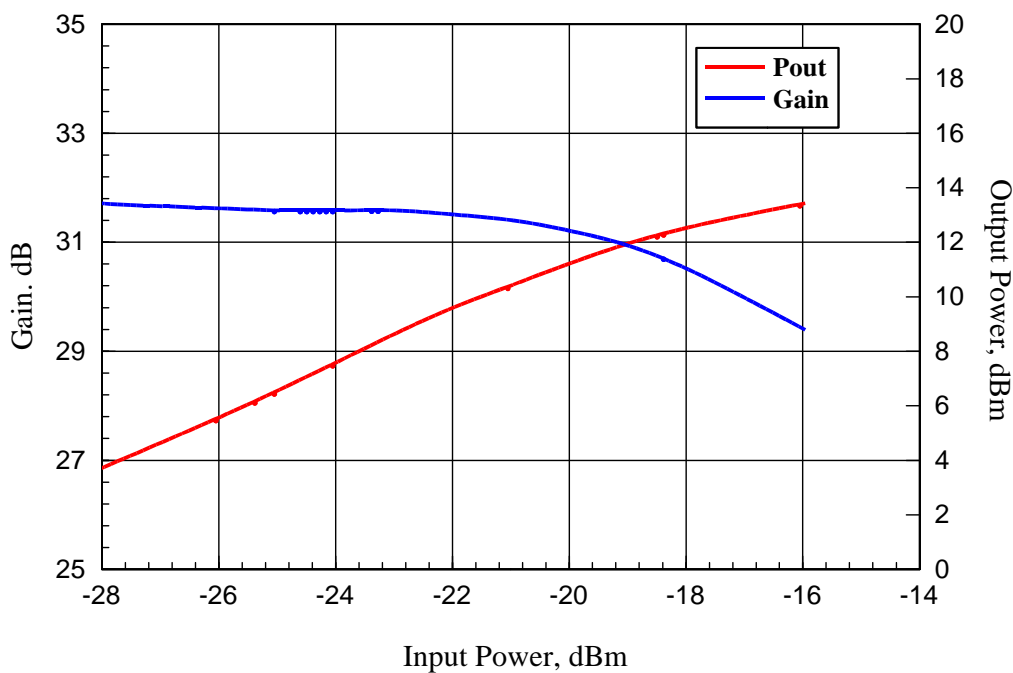



BROADBAND LOW NOISE AMPLIFIER
ABL0150-01-3025

Absolute Maximum Ratings

DC Voltage	+15V
RF Input Power	+18dBm
Storage Temperature	-55~+125°C
Operating Temperature	-40~+75°C