

# Analog Devices Welcomes Hittite Microwave Corporation

NO CONTENT ON THE ATTACHED DOCUMENT HAS CHANGED



**THIS PAGE INTENTIONALLY LEFT BLANK**

### Typical Applications

The HMC375LP3 / HMC375LP3E is ideal for basestation receivers:

- GSM, GPRS & EDGE
- CDMA & W-CDMA
- DECT

### Features

- Noise Figure: 0.9 dB
- Output IP3: +34 dBm
- Gain: 17 dB
- Very Stable Gain vs. Supply & Temperature
- Single Supply: +5V @ 136 mA
- 50 Ohm Matched Output

### Functional Diagram

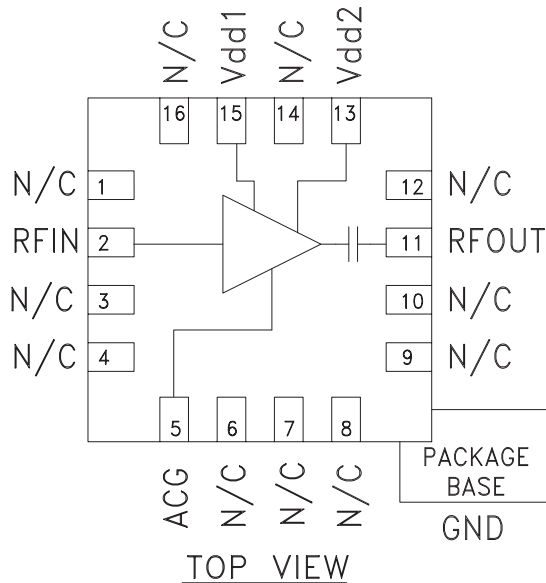

### General Description

The HMC375LP3 & HMC375LP3E high dynamic range GaAs PHEMT MMIC Low Noise Amplifiers are ideal for GSM & CDMA cellular basestation front-end receivers operating between 1.7 and 2.2 GHz. This LNA has been optimized to provide 0.9 dB noise figure, 17 dB gain and +33 dBm output IP3 from a single supply of +5V @ 136mA. Input and output return losses are 14 dB typical with the LNA requiring minimal external components to optimize the RF input match, RF ground and DC bias. For applications which require improved noise figure, please see the HMC618LP3(E).

### Electrical Specifications, $T_A = +25^\circ C$ , $V_s = +5V$

Parameter	Min.	Typ.	Max.	Min.	Typ.	Max.	Min.	Typ.	Max.	Min.	Typ.	Max.	Units
Frequency Range	1.8 - 1.9			1.9 - 2.0			2.0 - 2.1			2.1 - 2.2			GHz
Gain	16.5	18.5		15.5	17.5		15	17		13	15		dB
Gain Variation Over Temperature		0.014	0.021		0.014	0.021		0.014	0.021		0.014	0.021	dB/°C
Noise Figure		1.0	1.35		0.95	1.2		0.9	1.2		0.9	1.3	dB
Input Return Loss		12			13			14			15		dB
Output Return Loss		13			16			11			8		dB
Reverse Isolation		35			34			34			34		dB
Output Power for 1dB Compression (P1dB)	16	18.5		16	18.5		15	18		14.5	17.5		dBm
Saturated Output Power (P <sub>sat</sub> )		19.5			19.5			19.5			19.5		dBm
Output Third Order Intercept (IP3) (-20 dBm Input Power per tone, 1 MHz tone spacing)		34			33.5			33			32.5		dBm
Supply Current (I <sub>dd</sub> )		136			136			136			136		mA



**Broadband Gain & Return Loss**

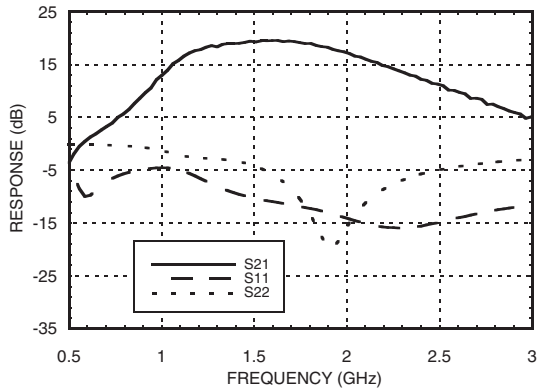

**Noise Figure vs. Temperature**

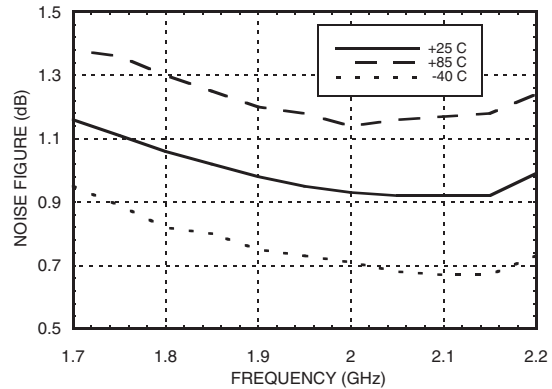

**Gain vs. Temperature**

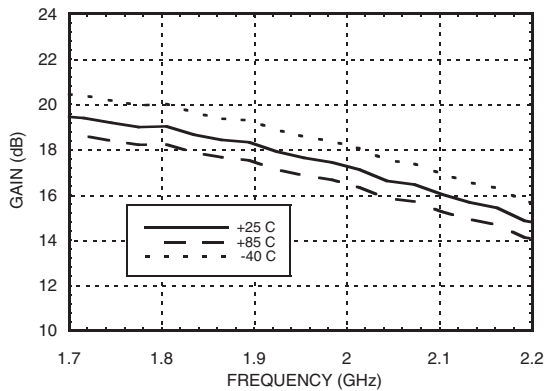

**Noise Figure vs. Vdd**

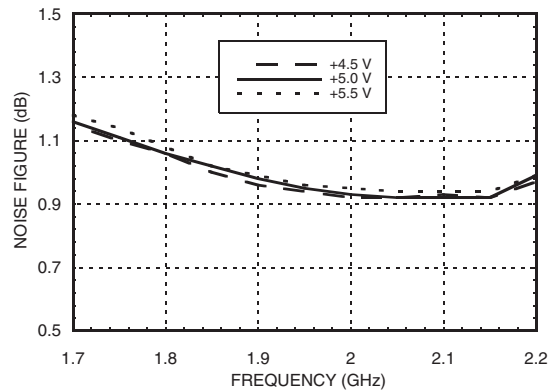

**Gain vs. Vdd**

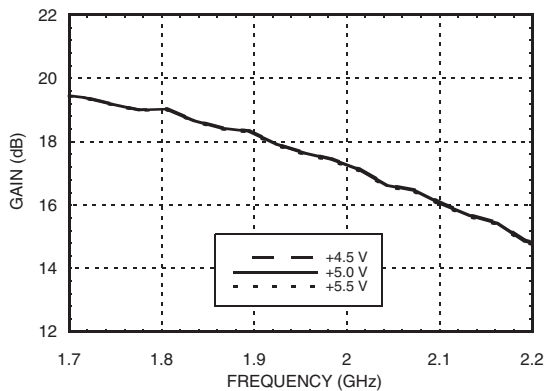

**Reverse Isolation vs. Temperature**

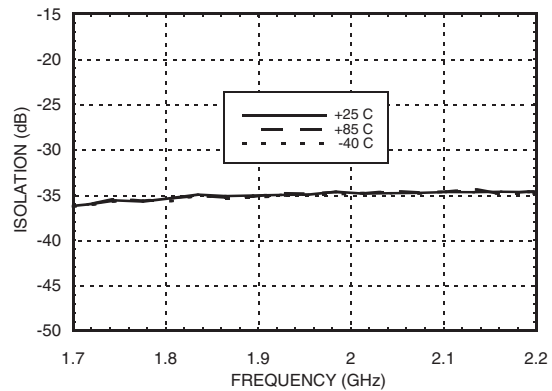

**Input Return Loss vs. Temperature**

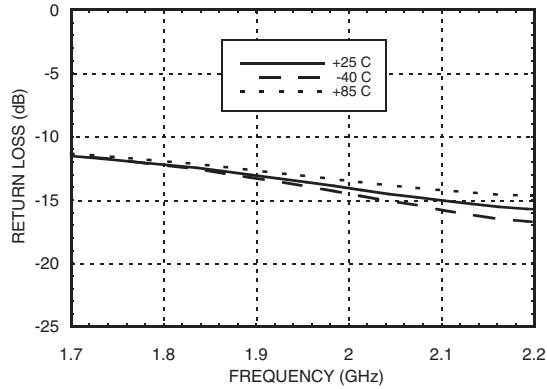

**Output Return Loss vs. Temperature**

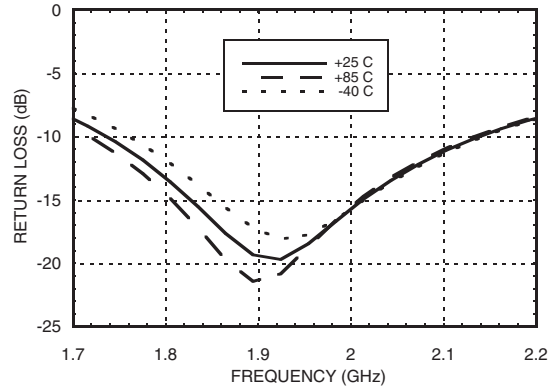

**Output IP3 vs. Temperature**

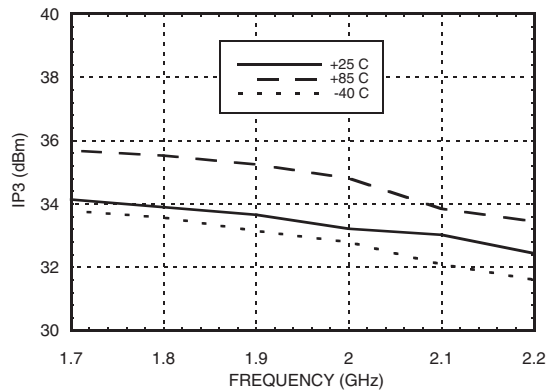

**P1dB & PSAT vs. Temperature**

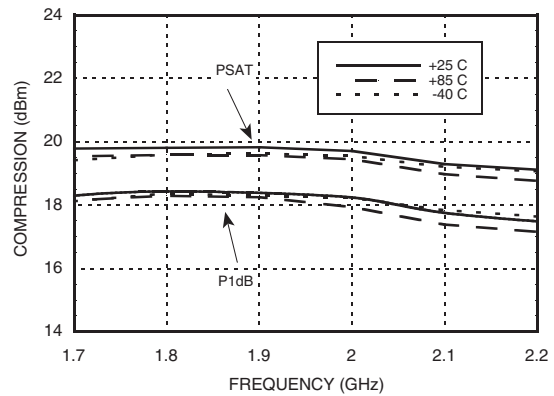

**Output IP3 vs. Vdd**

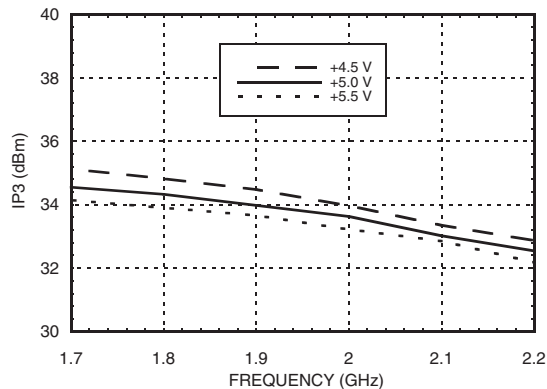

**P1dB vs. Vdd**

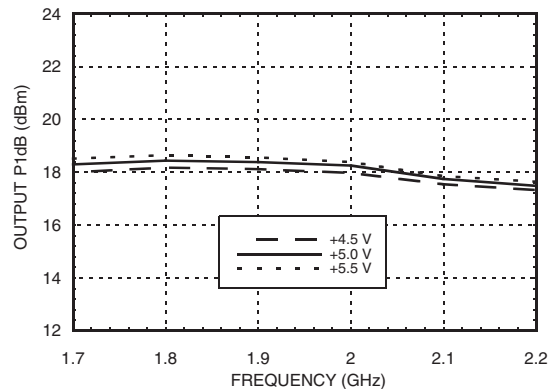

### Absolute Maximum Ratings

Drain Bias Voltage (Vdd1, Vdd2)	+8.0 Vdc
RF Input Power (RFIN)(Vs = +5.0 Vdc)	+10 dBm
Channel Temperature	150 °C
Continuous P <sub>diss</sub> (T = 85 °C) (derate 15.6 mW/°C above 85 °C)	1.015 W
Thermal Resistance (channel to ground paddle)	64.1 °C/W
Storage Temperature	-65 to +150 °C
Operating Temperature	-40 to +85 °C

### Typical Supply Current vs. Vdd

Vdd (Vdc)	I <sub>dd</sub> (mA)
+4.5	135
+5.0	136
+5.5	137



ELECTROSTATIC SENSITIVE DEVICE  
OBSERVE HANDLING PRECAUTIONS

### Outline Drawing

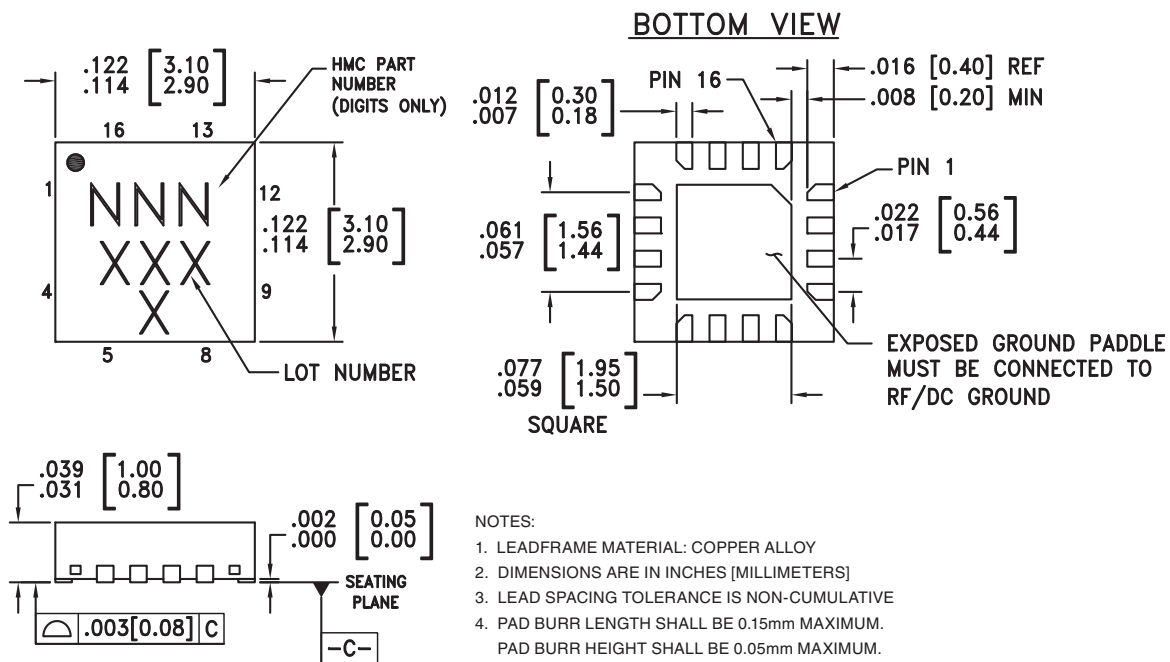

- NOTES:
1. LEADFRAME MATERIAL: COPPER ALLOY
  2. DIMENSIONS ARE IN INCHES [MILLIMETERS]
  3. LEAD SPACING TOLERANCE IS NON-CUMULATIVE
  4. PAD BURR LENGTH SHALL BE 0.15mm MAXIMUM.  
PAD BURR HEIGHT SHALL BE 0.05mm MAXIMUM.
  5. PACKAGE WARP SHALL NOT EXCEED 0.05mm.
  6. ALL GROUND LEADS AND GROUND PADDLE MUST BE SOLDERED TO PCB RF GROUND.
  7. REFER TO HITTITE APPLICATION NOTE FOR SUGGESTED LAND PATTERN.

### Package Information

Part Number	Package Body Material	Lead Finish	MSL Rating	Package Marking <sup>[3]</sup>
HMC375LP3	Low Stress Injection Molded Plastic	Sn/Pb Solder	MSL1 <sup>[1]</sup>	375 XXXX
HMC375LP3E	RoHS-compliant Low Stress Injection Molded Plastic	100% matte Sn	MSL1 <sup>[2]</sup>	375 XXXX



[1] Max peak reflow temperature of 235 °C

[2] Max peak reflow temperature of 260 °C

[3] 4-Digit lot number XXXX

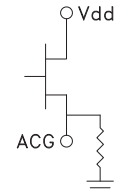

### Pin Descriptions

Pin Number	Function	Description	Interface Schematic
1, 3, 4, 6-10, 12, 14, 16	N/C	No connection necessary. These pins may be connected to RF/DC ground.	
2	RFIN	This pin is matched to 50 Ohms with a 13 nH inductor to ground. See Application Circuit.	RFIN ○ —
5	ACG	AC Ground - An external capacitor of 0.01μF to ground is required for low frequency bypassing. See Application Circuit for further details.	
11	RFOUT	This pin is AC coupled and matched to 50 Ohms.	—    ○ RFOUT
13,15	Vdd2, Vdd1	Power supply voltage. Choke inductor and bypass capacitor are required. See application circuit.	
	GND	Package bottom must be connected to RF/DC ground.	○ GND ⏏

### Application Circuit

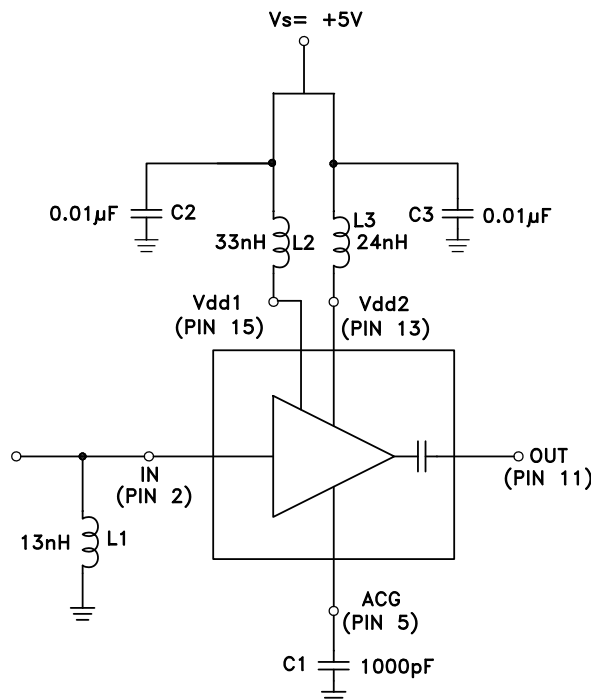

Note: L1, L2, L3 and C1 should be located as close to pins as possible.

**Evaluation PCB**

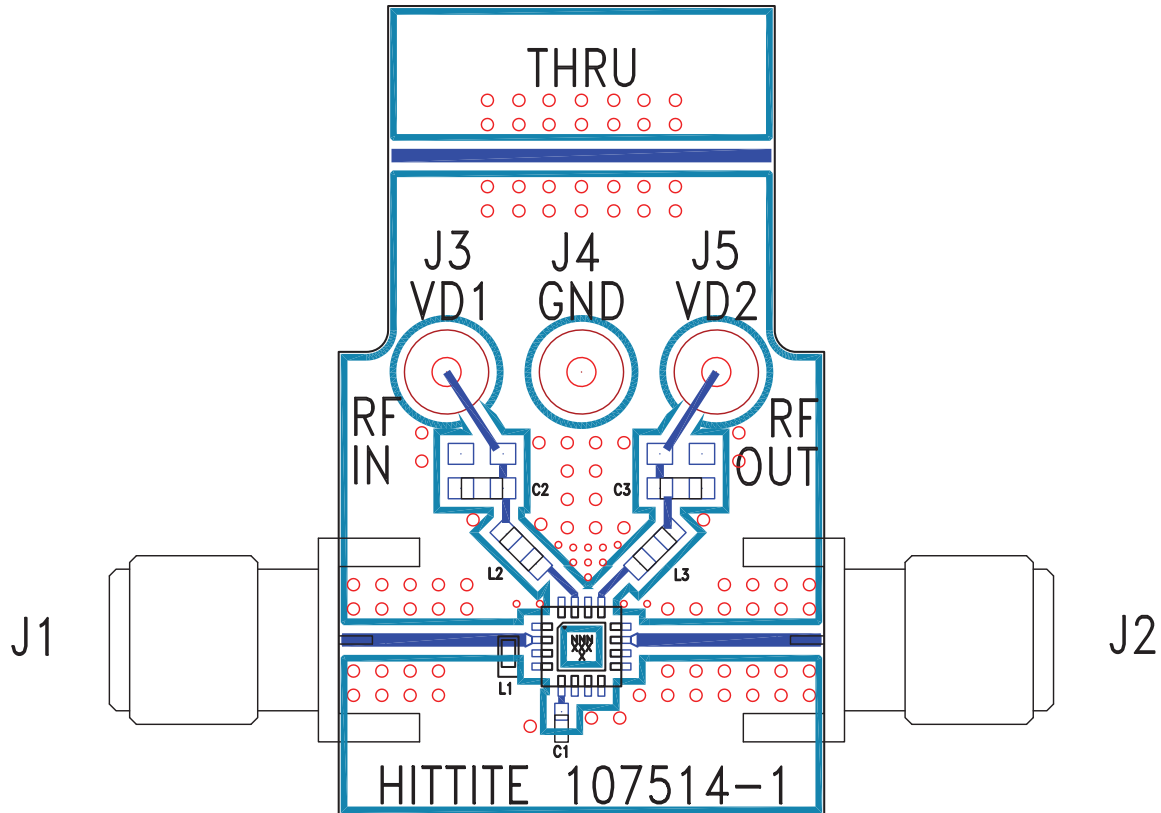

**List of Materials for Evaluation PCB 107726 [1]**

Item	Description
J1 - J2	PCB Mount SMA RF Connector
J3 - J4	DC Pin
C1	1000 pF Capacitor, 0402 Pkg.
C2, C3	10000 pF Capacitor, 0603 Pkg.
L1	13nH Inductor, 0402 Pkg.
L2	33nH Inductor, 0603 Pkg.
L3	24nH Inductor, 0402 Pkg.
U1	HMC375LP3 / HMC375LP3E Amplifier
PCB [2]	107514 Evaluation PCB

The circuit board used in the application should use RF circuit design techniques. Signal lines should have 50 Ohm impedance while the package ground leads and exposed paddle should be connected directly to the ground plane similar to that shown. A sufficient number of via holes should be used to connect the top and bottom ground planes. The evaluation circuit board shown is available from Hittite upon request.

[1] Reference this number when ordering complete evaluation PCB

[2] Circuit Board Material: Rogers 4350