

Features:

- Broad bandwidth, high gain, specification from 10MHz to 6 GHz, usable from 10MHz to 7.5 GHz
- Low VSWR, unconditional stable
- Small size, low cost
- SMA female connector I/O
- Single DC power supply, internal voltage regulator, operating voltage from +9~+15V
- Operating temperature -40~+75°C, storage temperature -55~+125°C

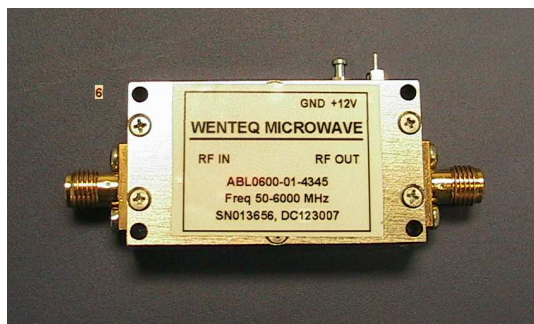

Electrical Specifications

Parameters	Minimum	Typical	Maximum
Frequency Range	10 MHz		6000MHz
Noise Figure (from 50MHz)		4.5 dB	5.0 dB
Nominal SS Gain @25°C	40 dB	43dB	46 dB
P-1dB Compression Point			
100MHz	+13dBm	+15 dBm	
3 GHz	+12 dBm	+14 dBm	
6GHz	+11 dBm	+13 dBm	
Gain flatness		+/-1.25 dB	+/-1.50 dB
Gain Variation		+/-1.5 dB	
Input VSWR		1.5:1	1.8:1
Output VSWR		1.5:1	1.8:1
Reverse Isolation	55dB	60dB	
Spurious			-60 dBc
Operating Temperature	-40°C		+75°C
Survival Temperature	-55°C		+125°C
DC Voltage	+9V	+12 V	+15 V
DC Supply Current	140 mA	160 mA	180 mA
In/Out connectors	SMA female		
Size	1.7"x0.95"x0.375		

Functional Diagram

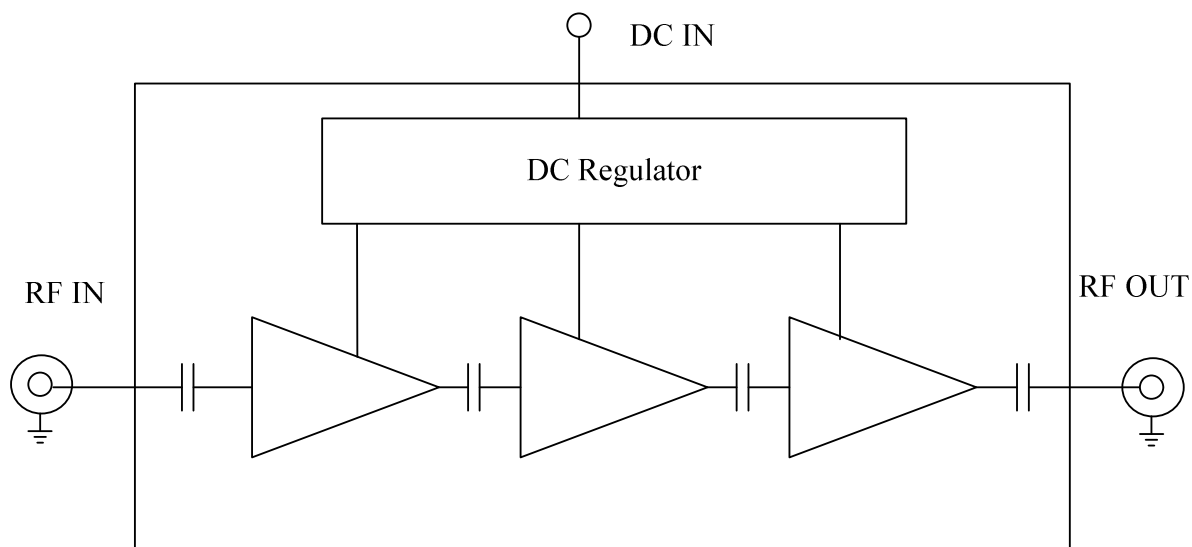

Mechanical Structure:

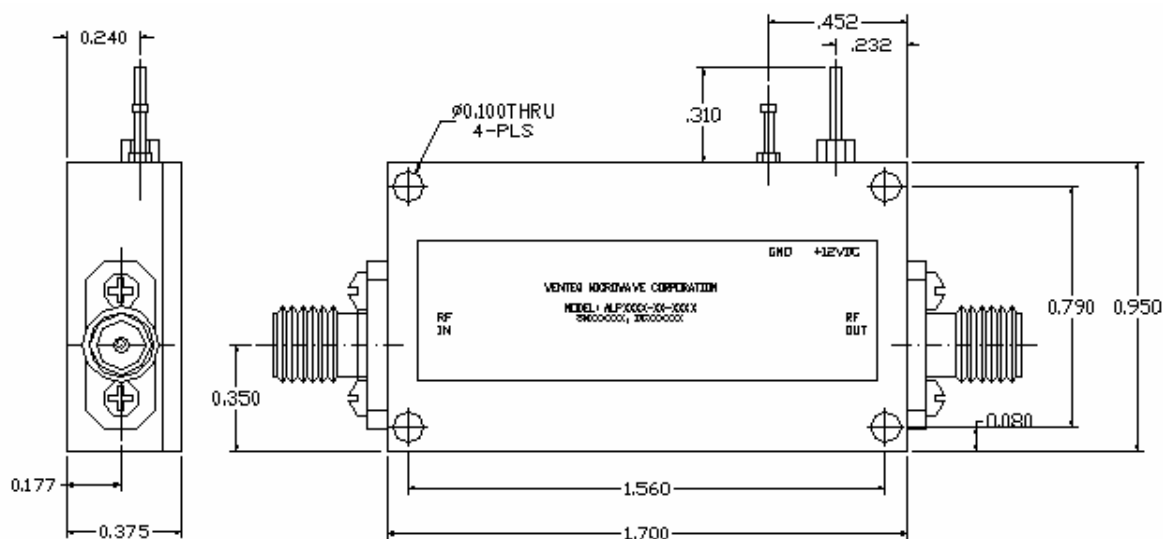

Note: All units in inches.

Typical Test Results:

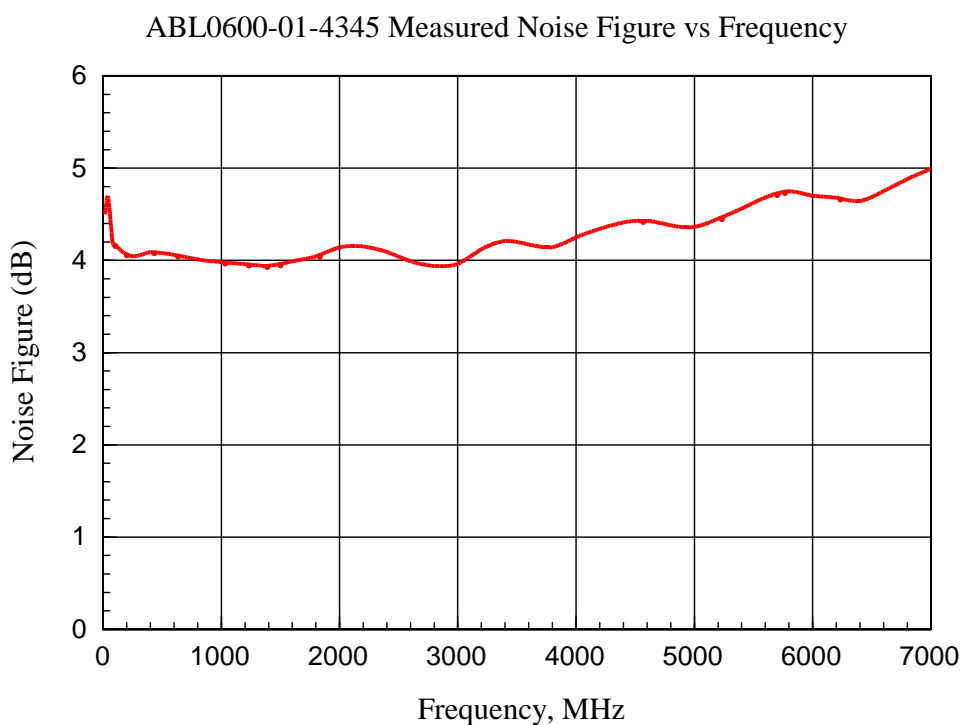
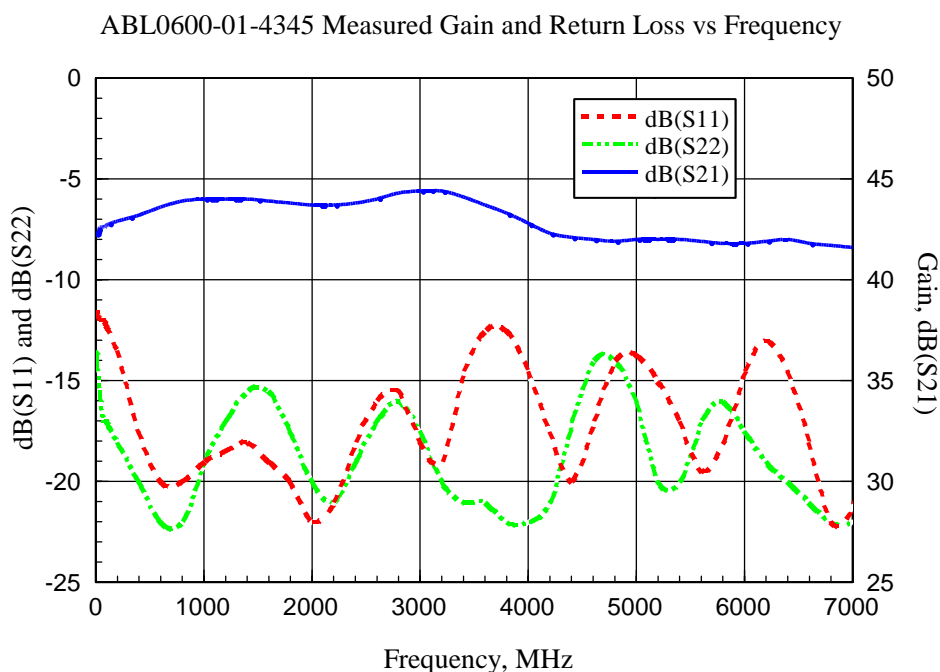

ABL0600-01-4345 Measured Gain and Output Power vs Input Power  
Test Frequency: 100MHz

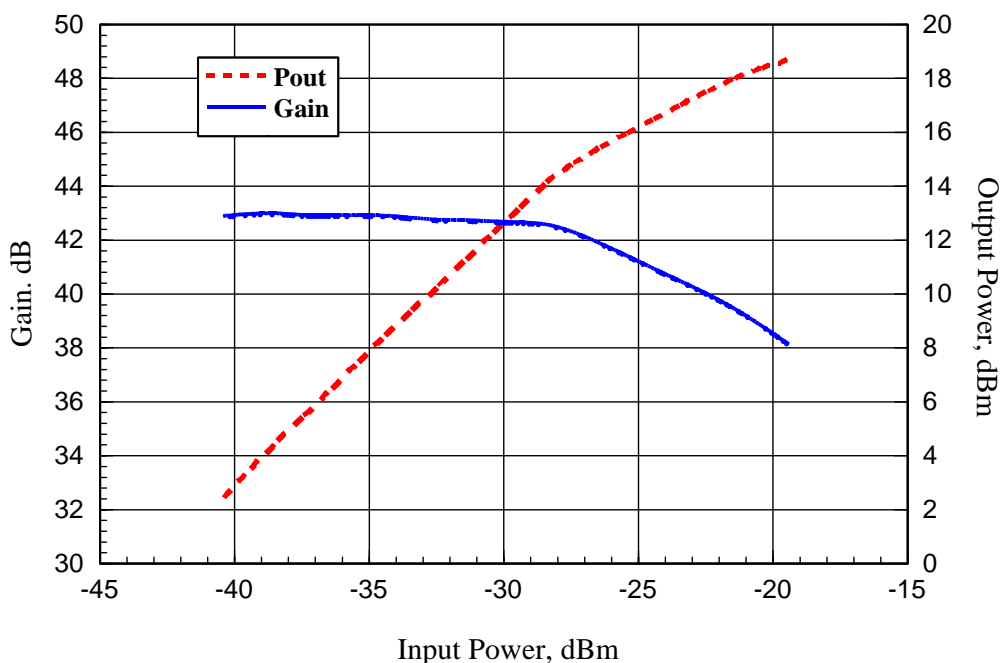

ABL0600-01-4345 Measured Gain and Output Power vs Input Power  
Test Frequency: 3000MHz

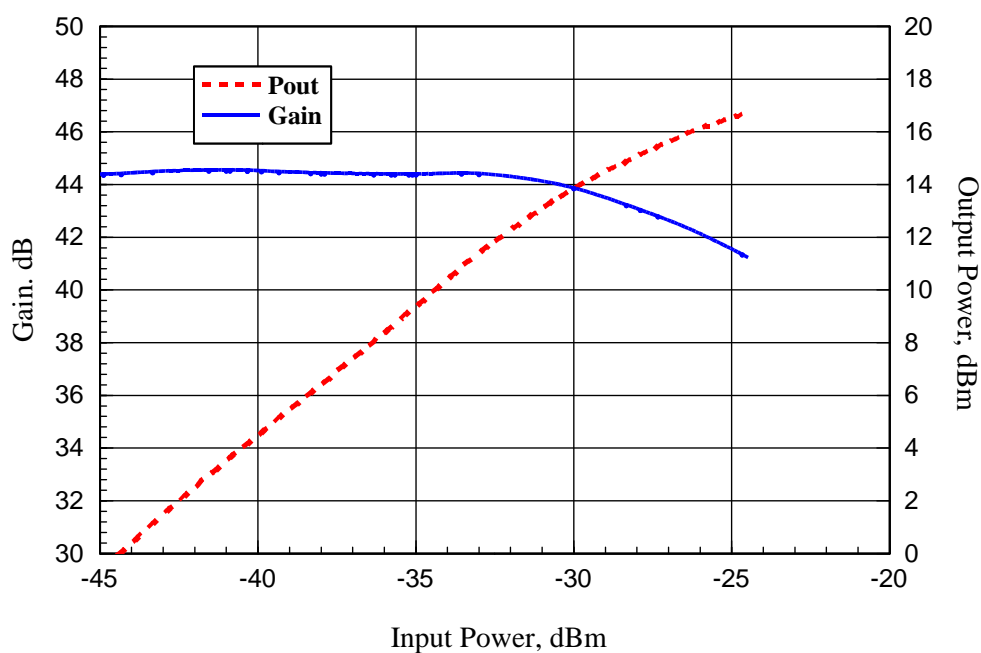

ABL0600-01-4345 Measured Gain and Output Power vs Input Power  
Test Frequency: 6000MHz

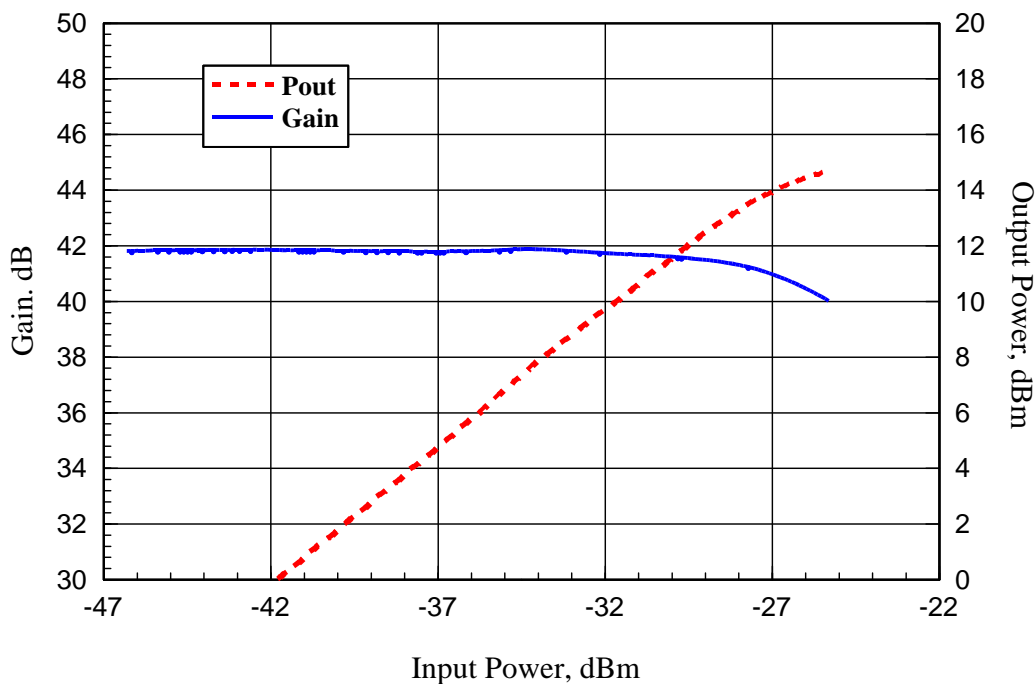

**Absolute Maximum Ratings**

DC Voltage	+15V
RF Input Power	+10 dBm
Storage Temperature	-55~+125°C
Operating Temperature	-40~+75°C