

Coaxial Circulators

Part Number: KTCC-0301A

Main Features:

- Frequency Range: 0.3GHz - 0.4GHz
- Small Size, High Isolation, Low Insertion Loss, High Power Handling
- Wide Operating Temperature: -15°C~+60°C
- Commercial, Military and Space Applications

Electrical Specifications at Room Temperature:

Part Number	Freq. Range (GHz)	Bandwidth Max. (MHz)	Insertion Loss Max. (dB)	Isolation Min. (dB)	VSWR Max.	Average Power (W)	Connector Type
KTCC-0301A	0.3 - 0.4	30	0.3	25	1.20	150	SMA/N

Mechanical Dimensions (mm):

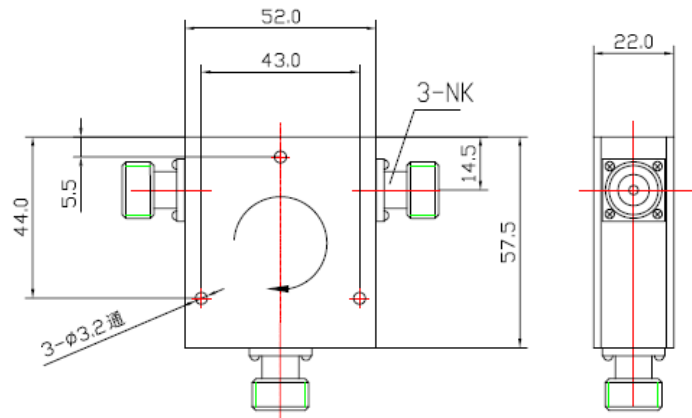

HOW TO ORDER

