

## ASF143 Data Sheet

*3.3 V IF Gain Block Amplifier MMIC over DC~1000 MHz*

### 1. Product Overview

#### 1.1 General Description

ASF143, 3.3V internally matched IF gain block amplifier MMIC, has excellent input and output return loss, high linearity, and low noise over a wide range of frequency DC~1000 MHz, being suitable for use in both receiver and transmitter of telecommunication systems up to 1 GHz. The amplifier is available in a SOT343 package and passes through the stringent 100% DC & RF test via an automated test handler.



#### 1.2 Features

- 22.6 dB Gain at 150 MHz
- 20 dBm P1dB at 150 MHz
- 38 dBm Output IP3 at 150 MHz
- 2.0 dB NF at 150 MHz
- MTTF > 100 Years
- Minimum External Matching Components
- Single Supply: +3.3 V

#### 1.3 Applications

- Base Station Infrastructure
- Repeater
- Telecommunication System

#### 1.4 Package Profile & RoHS Compliance

	
<p>SOT343, 2.15x2.0 mm<sup>2</sup>, surface mount</p>	<p>RoHS-compliant</p>

## 2. Summary on Product Performances

### 2.1 Typical Performance

Supply voltage = +3.3 V, T<sub>A</sub> = +25 °C, Z<sub>O</sub> = 50 Ω.

Parameter	Typical					Unit
Frequency	70	150	300	450	900	MHz
Gain	22.7	22.6	22.3	21.8	19.9	dB
S11	-18.5	-22.0	-21.0	-19.0	-13.0	dB
S22	-21.0	-21.0	-19.0	-15.5	-9.0	dB
Noise Figure	1.8	2.0	2.0	2.0	2.1	dB
Output IP3 <sup>1)</sup>	37.5	38.0	38.5	36.5	35.0	dBm
Output P1dB	19.5	20.0	20.0	19.5	19.0	dBm
Current	87					mA
Device Voltage	+3.3					V

1) OIP3 is measured with two tones at the output power of +5 dBm/tone separated by 1 MHz.

### 2.2 Product Specification

Supply voltage = +3.3 V, T<sub>A</sub> = +25 °C, Z<sub>O</sub> = 50 Ω.

Parameter	Min	Typ	Max	Unit
Frequency		150		MHz
Gain		22.6		dB
S11		-22		dB
S22		-21		dB
Noise Figure		2.0		dB
Output IP3		38		dBm
Output P1dB		20		dBm
Current		87		mA
Device Voltage		+3.3		V

### 2.3 Pin Configuration

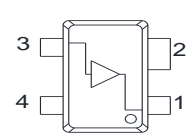
Pin	Description	Simplified Outline
1	RF_OUT & Bias	
2, 4	Ground	
3	RF_IN	

## 2.4 Absolute Maximum Ratings

Parameters	Max. Ratings
Operation Case Temperature	-40 to +85 °C
Storage Temperature	-40 to +150 °C
Device Voltage	+6 V
Operation Junction Temperature	+150 °C
Input RF Power (CW, 50 Ω matched)	+25 dBm

## 2.5 Thermal Resistance

Symbol	Description	Typ	Unit
R <sub>th</sub>	Thermal resistance from junction to lead	45	°C/W

## 2.6 ESD Classification & Moisture Sensitivity Level

### ESD Classification

HBM	Class 1B	Voltage Level: 500 ~ 1000 V
MM	Class A	Voltage Level: <200 V

CAUTION: Gallium Arsenide Integrated Circuits are sensitive to electrostatic discharge (ESD) and can be damaged by static electricity. Proper ESD control techniques should be used when handling these devices.

### Moisture Sensitivity Level

MSL 3 at 260 °C reflow
------------------------

*(Intentionally Blanked)*

## 3. Application: 50 ~ 1000 MHz (IF, $V_{\text{supply}} = +3.3 \text{ V}$ )

### 3.1 Application Circuit & Evaluation Board

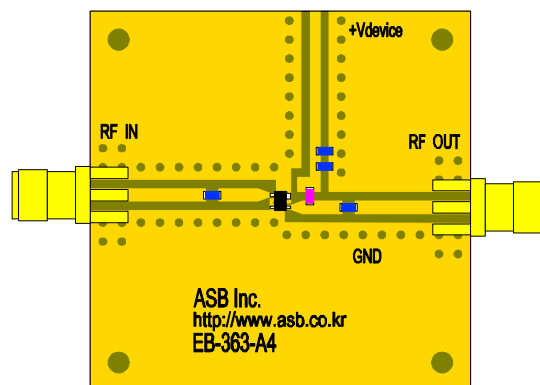
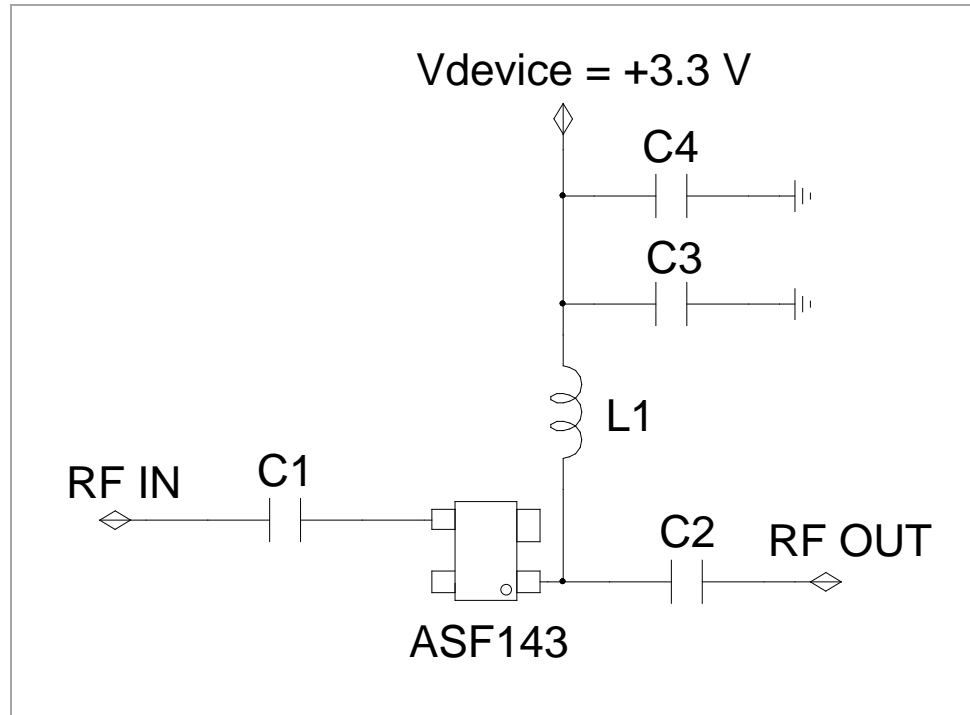

#### PCB Information

Material	FR4
Thickness (mm)	0.8
Size (mm)	40x40
EB No.	EB-363-A4

#### Bill of Material

Symbol	Value	Size	Description	Manufacturer
ASF143	-	-	MMIC Amplifier	ASB
C1, C2	1 nF	0603	DC blocking capacitor	Murata
C3	100 pF	0603	Bypass capacitor	Murata
C4	1 $\mu$ F	0603	Decoupling capacitor	Murata
L1	680 nH	0603	RF choke inductor	Samsung

## 3.2 Performance Table

Supply voltage = +3.3 V,  $T_A = +25\text{ }^\circ\text{C}$ ,  $Z_0 = 50\ \Omega$ .

Parameter	Typical					Unit
Frequency	70	150	300	450	900	MHz
Gain	22.7	22.6	22.3	21.8	19.9	dB
S11	-18.5	-22.0	-21.0	-19.0	-13.0	dB
S22	-21.0	-21.0	-19.0	-15.5	-9.0	dB
Noise Figure	1.8	2.0	2.0	2.0	2.1	dB
Output IP3 <sup>1)</sup>	37.5	38.0	38.5	36.5	35.0	dBm
Output P1dB	19.5	20.0	20.0	19.5	19.0	dBm
Current	87					mA
Device Voltage	+3.3					V

1) OIP3 is measured with two tones at the output power of +5 dBm/tone separated by 1 MHz.

## 3.3 Plot of S-parameter & Stability Factor

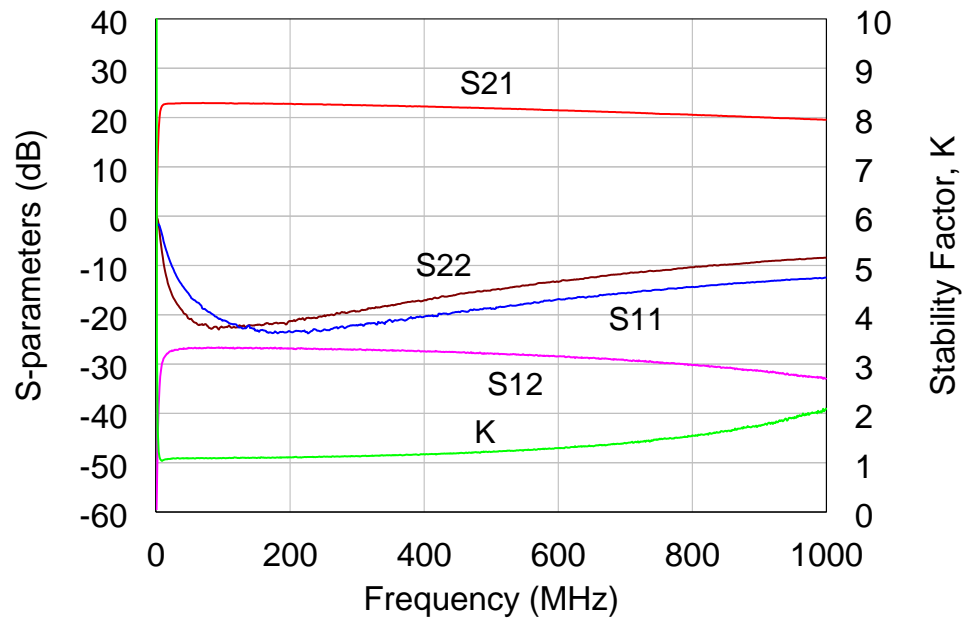

## 3.4 Plots of Noise Figure, ACLR (for LTE) and Performances with Temperature

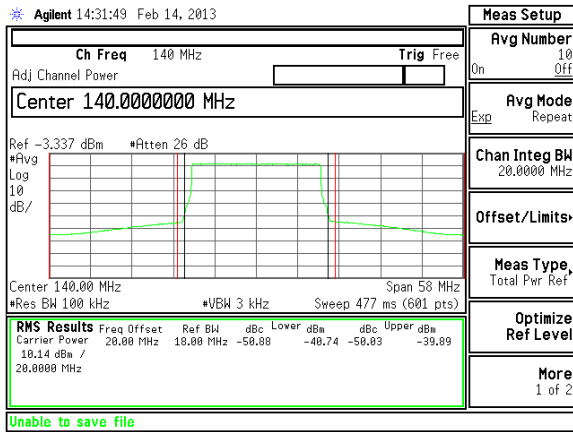
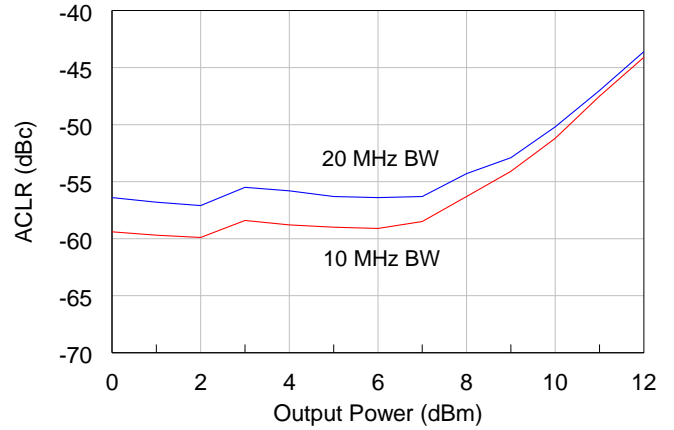
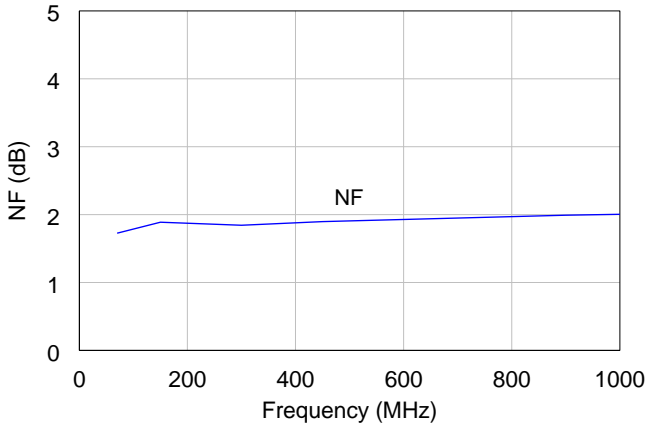

Note that ACLR test conditions are as follows;

- 1) Test Source: LTE\_FDD\_test model 3.1, BW: 10 MHz & 20 MHz, Test Frequency: 140 MHz
- 2) Test Source: LTE\_FDD\_test model 3.1, BW: 20 MHz, Test Frequency: 140 MHz

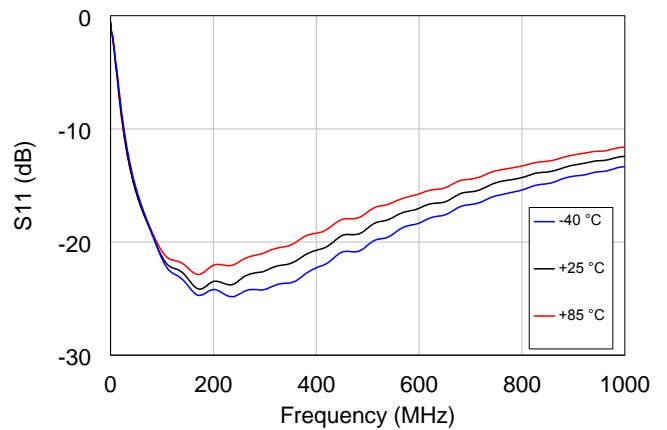
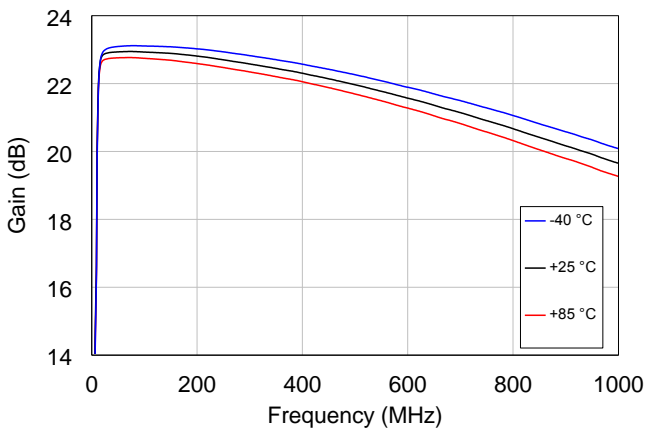

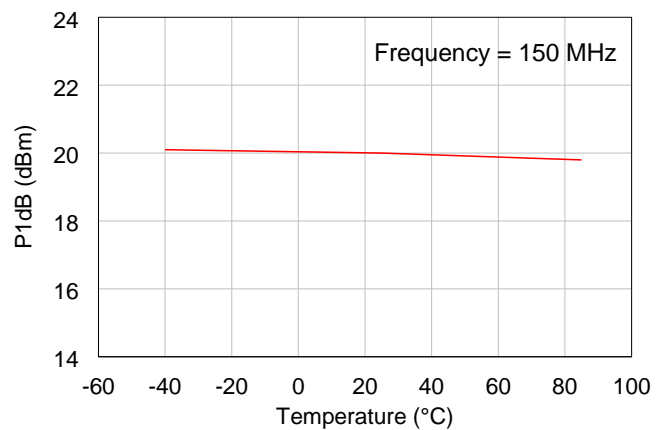
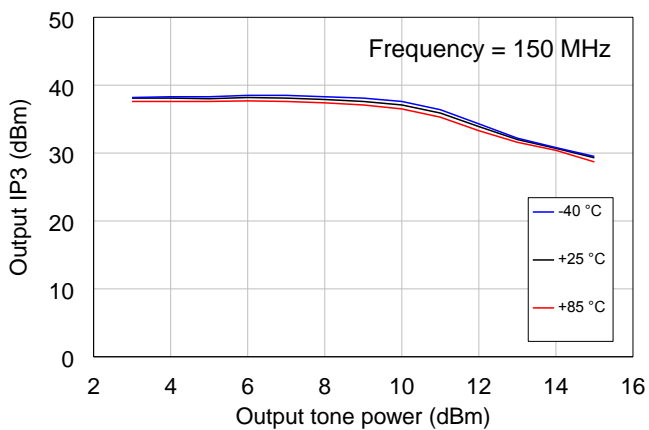
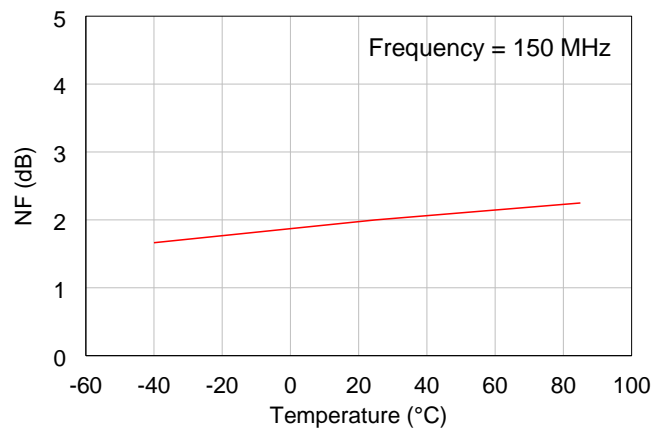
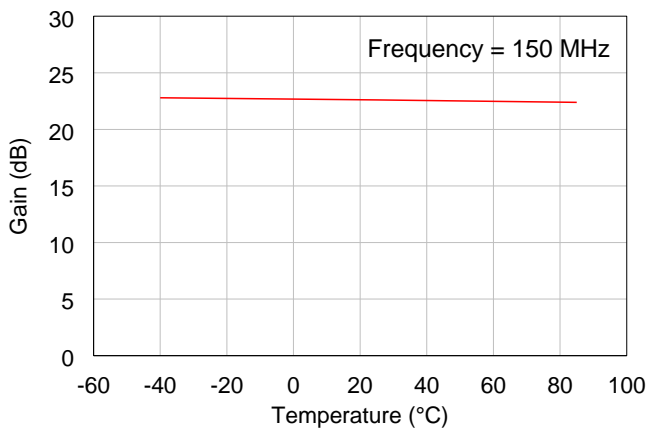
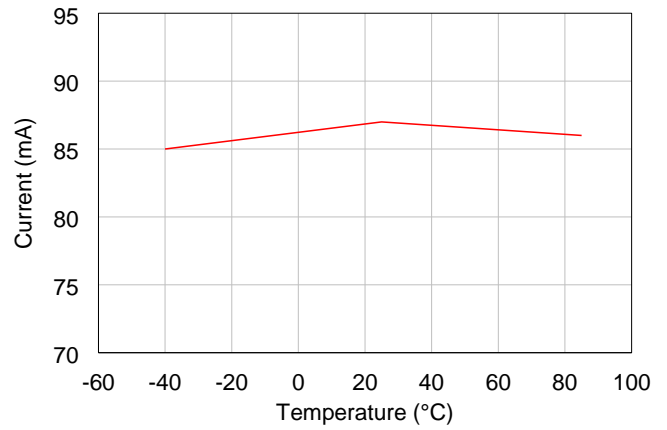
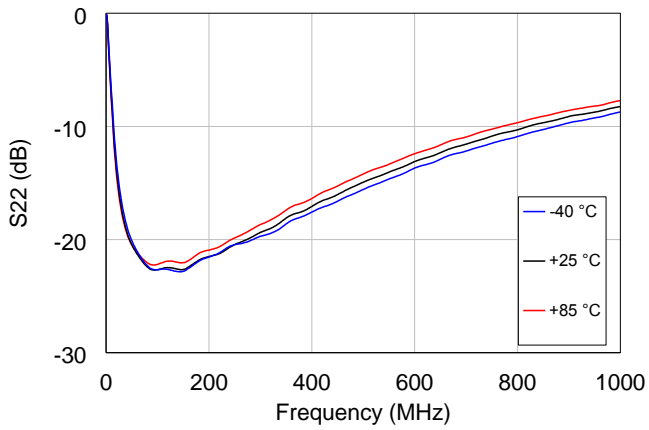

#### 4. Package Outline (SOT343, 2.15x2.0x1.0 mm)

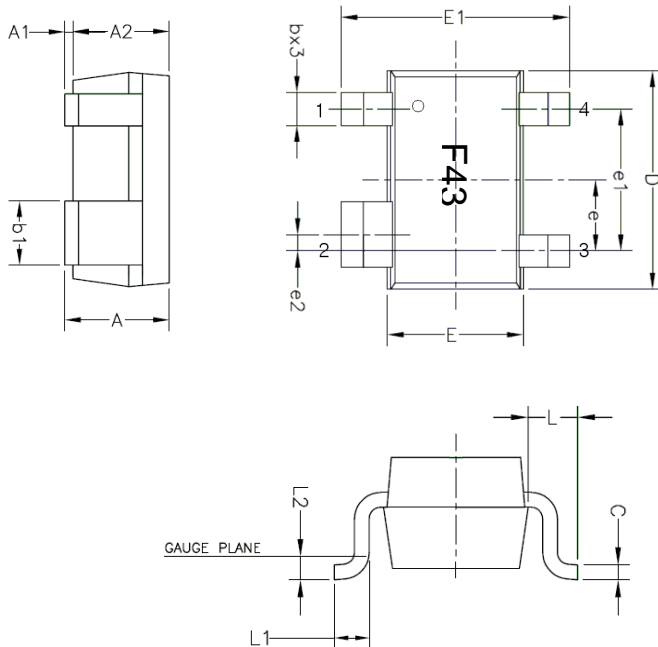

Symbols	Dimensions (In mm)	
	MIN	MAX
A	0.90	1.10
A1	0.025	0.10
A2	0.875	1.00
b	0.20	0.40
b1	0.50	0.70
C	0.10	0.15
D	1.90	2.10
E	1.15	1.35
E1	2.00	2.30
e	0.65BSC	
e1	1.30BSC	
e2	0.15BSC	
L	0.425REF	
L1	0.300REF	
L2	0.200REF	

#### 5. Surface Mount Recommendation (In mm)

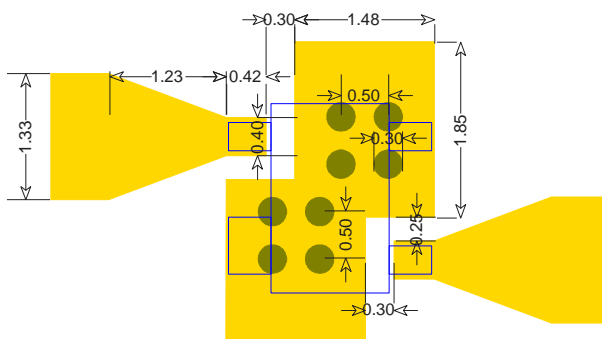

**NOTE**

1. The number and size of ground via holes in a circuit board are critical for thermal and RF grounding considerations.
2. Recommend is that the ground via holes be placed on the bottom of the ground leads and exposed pad of the device for better RF and thermal performance, as shown in the drawing at the left side.



## 6. Recommended Soldering Reflow Profile

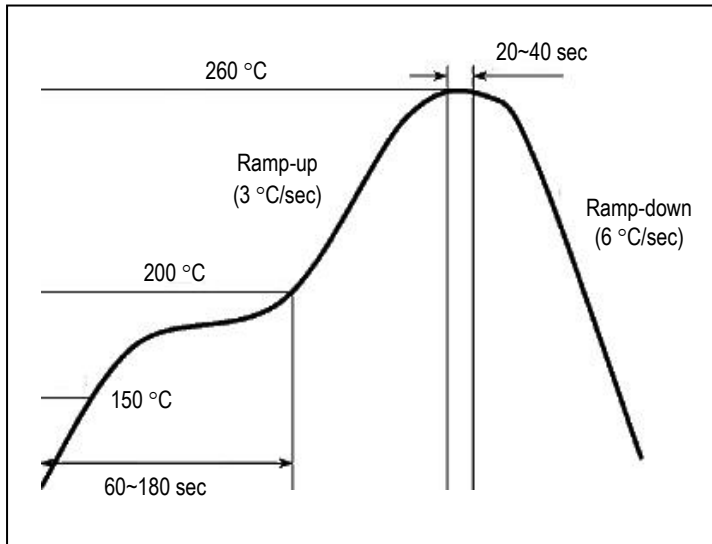

*(End of Datasheet)*