

Analog Devices Welcomes Hittite Microwave Corporation

NO CONTENT ON THE ATTACHED DOCUMENT HAS CHANGED



THIS PAGE INTENTIONALLY LEFT BLANK

Typical Applications

The HMC372LP3 / HMC372LP3E is ideal for basestation receivers:

- GSM, GPRS & EDGE
- CDMA & W-CDMA
- Private Land Mobile Radio

Features

- Noise Figure: < 1 dB
- Output IP3: +34 dBm
- Gain: 15 dB
- Very Stable Gain vs. Supply & Temperature
- Single Supply: +5V @ 100 mA
- 50 Ohm Matched Output

Functional Diagram

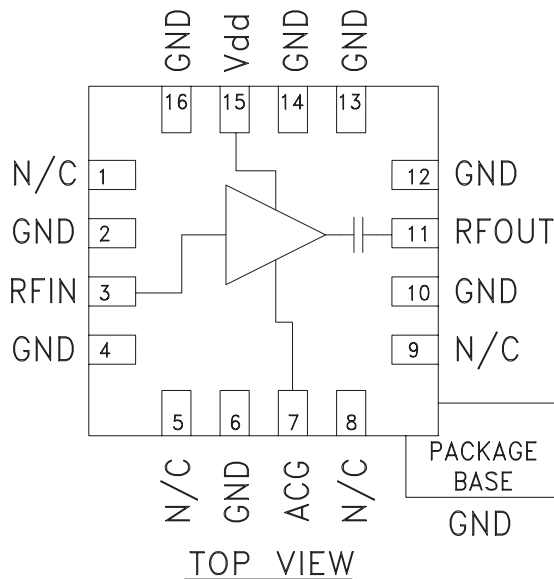

General Description

The HMC372LP3 & HMC372LP3E are GaAs PHEMT MMIC Low Noise Amplifiers that are ideal for GSM & CDMA cellular basestation front-end receivers operating between 700 and 1000 MHz. The amplifier has been optimized to provide 1 dB noise figure, 15 dB gain and +34 dBm output IP3 from a single supply of +5V @ 100 mA. Input and output return losses are 25 and 14 dB respectively with the LNA requiring only four external components to optimize the RF Input match, RF ground and DC bias. For applications which require improved noise figure, please see the HMC617LP3(E).

Electrical Specifications, $T_A = +25^\circ C$, $V_S = +5V$

Parameter	Min.	Typ.	Max.	Min.	Typ.	Max.	Units
Frequency Range	810 - 960			700 - 1000			MHz
Gain	12.5	14.5		11.5	14.5		dB
Gain Variation Over Temperature		0.008	0.015		0.008	0.015	dB / °C
Noise Figure		1.0	1.3		1.0	1.3	dB
Input Return Loss		25			25		dB
Output Return Loss		14			12		dB
Reverse Isolation		20			22		dB
Output Power for 1dB Compression (P1dB)	18	21		17	20		dBm
Saturated Output Power (Psat)		23.5			22.5		dBm
Output Third Order Intercept (IP3) (-20 dBm Input Power per tone, 1 MHz tone spacing)		34		30	33		dBm
Supply Current (I _{dd})		100			100		mA



**GaAs PHEMT MMIC LOW NOISE
AMPLIFIER, 700 - 1000 MHz**

Broadband Gain & Return Loss

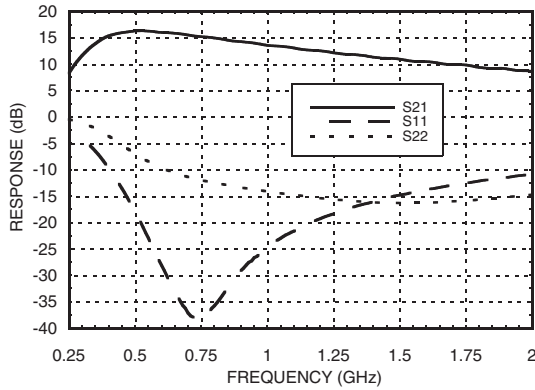

Gain, Noise Figure & Power vs. Supply Voltage @ 850MHz

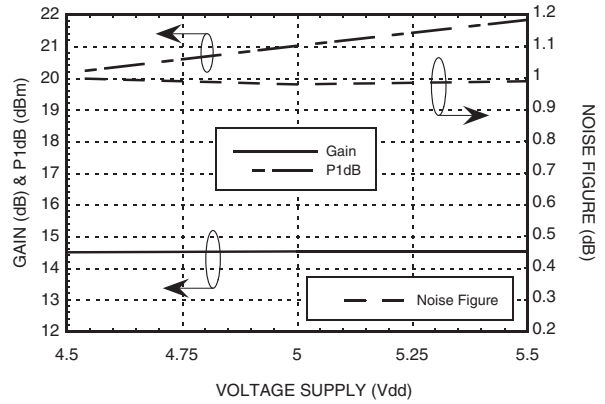

Gain vs. Temperature

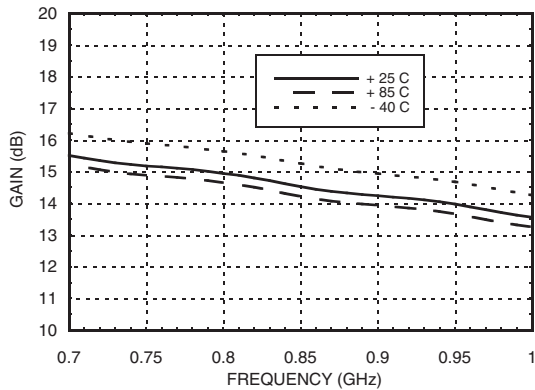

Noise Figure vs. Temperature

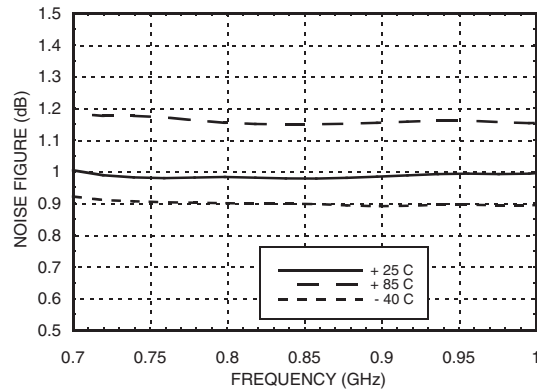

Gain vs. Vdd

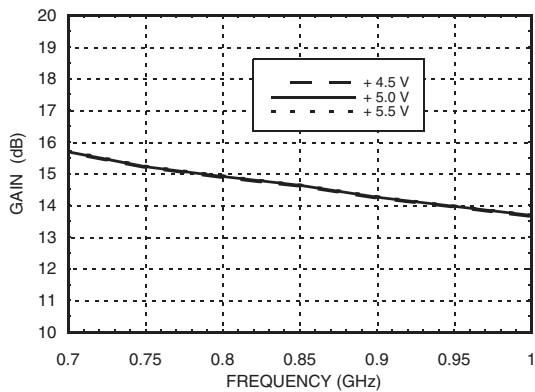

Noise Figure vs. Vdd

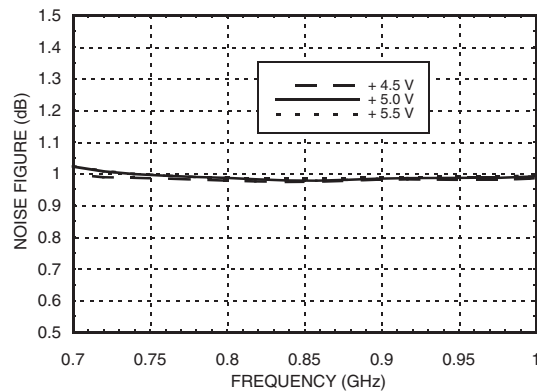



HMC372LP3 / 372LP3E

GaAs PHEMT MMIC LOW NOISE AMPLIFIER, 700 - 1000 MHz

Input Return Loss vs. Temperature

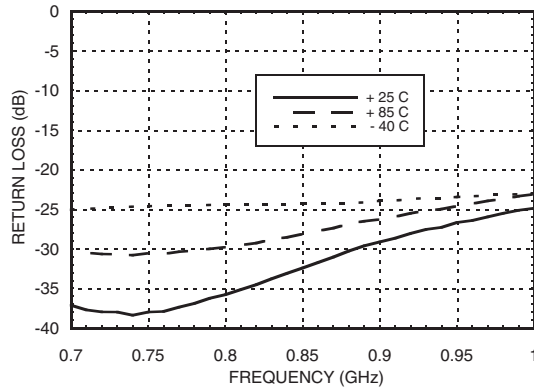

Output Return Loss vs. Temperature

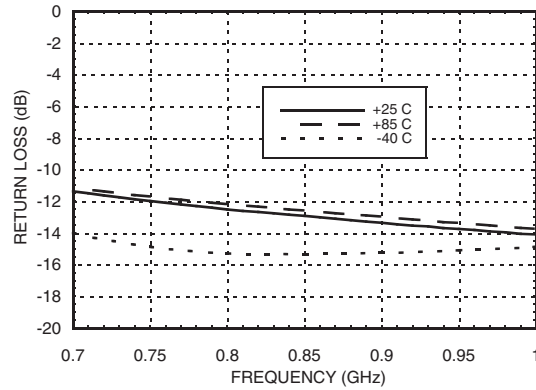

Output IP3 vs. Temperature

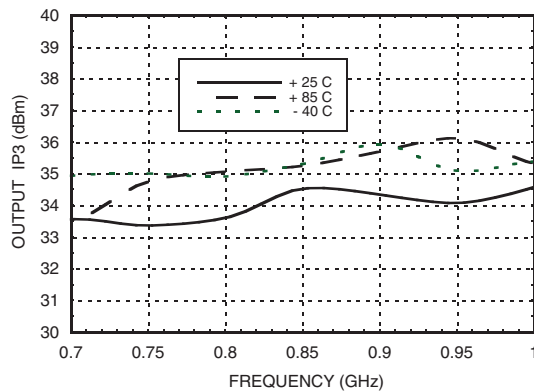

P1dB & Psat vs. Temperature

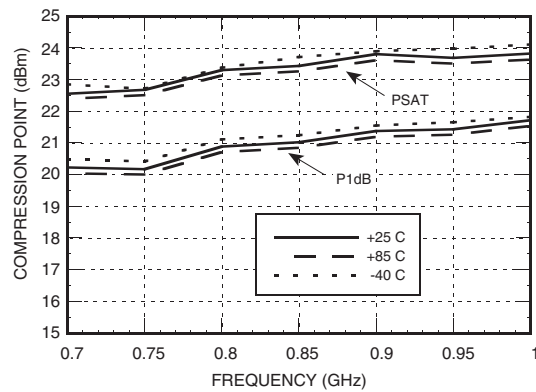

Output IP3 vs. Vdd

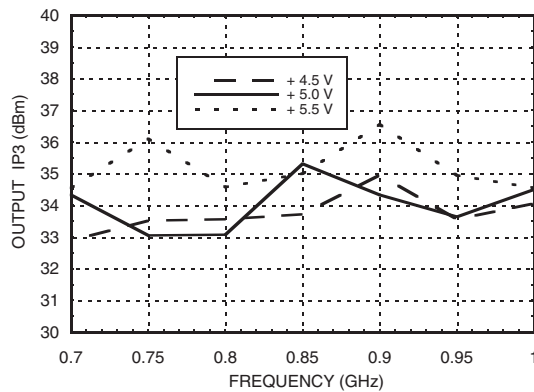

P1dB vs. Vdd

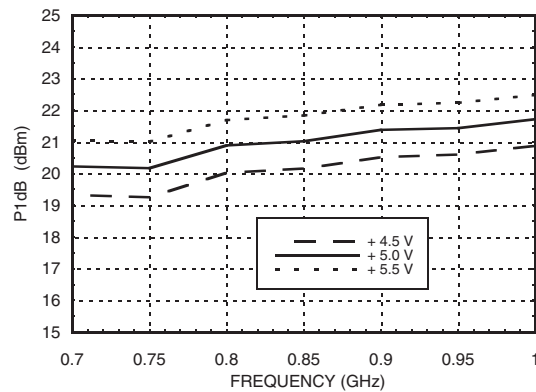



Output IP3 vs. Input Power @ 950 MHz

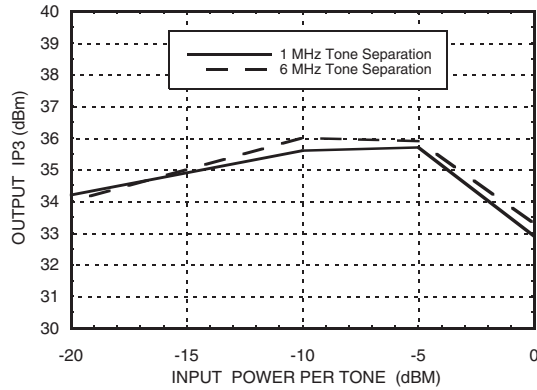

Reverse Isolation vs. Temperature

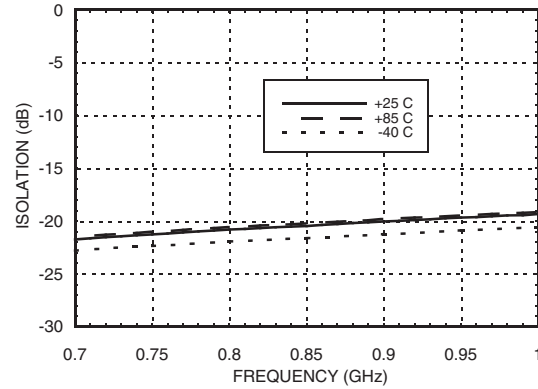

Absolute Maximum Ratings

Drain Bias Voltage (Vdd)	+8.0 Vdc
RF Input Power (RFIN)(Vs = +5.0 Vdc)	+15 dBm
Channel Temperature	150 °C
Continuous Pdiss (T = 85 °C) (derate 15.6 mW/°C above 85 °C)	1.015 W
Thermal Resistance (channel to ground paddle)	64.1 °C/W
Storage Temperature	-65 to +150 °C
Operating Temperature	-40 to +85 °C

Typical Supply Current vs. Vdd

Vdd (Vdc)	Idd (mA)
+4.5	98
+5.0	100
+5.5	102

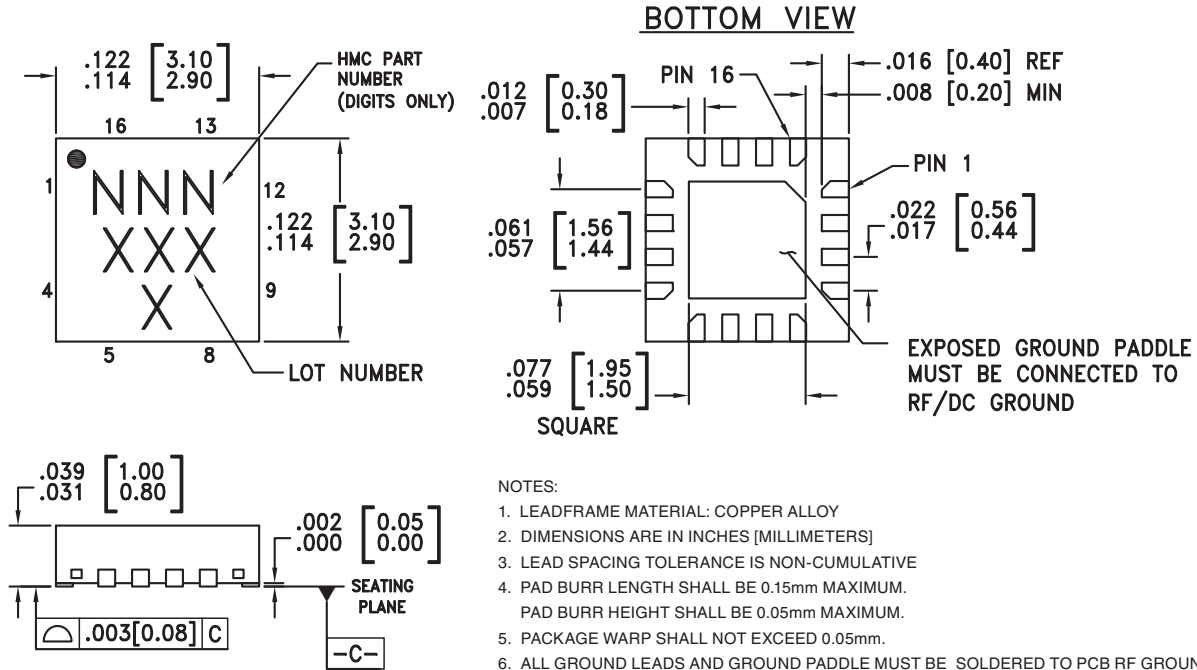

**ELECTROSTATIC SENSITIVE DEVICE
OBSERVE HANDLING PRECAUTIONS**

Outline Drawing

Package Information

Part Number	Package Body Material	Lead Finish	MSL Rating	Package Marking ^[3]
HMC372LP3	Low Stress Injection Molded Plastic	Sn/Pb Solder	MSL1 ^[1]	H372 XXXX
HMC372LP3E	RoHS-compliant Low Stress Injection Molded Plastic	100% matte Sn	MSL1 ^[2]	H372 XXXX

[1] Max peak reflow temperature of 235 °C

[2] Max peak reflow temperature of 260 °C

[3] 4-Digit lot number XXXX

Pin Descriptions

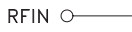
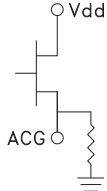
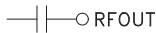
Pin Number	Function	Description	Interface Schematic
1, 5, 8, 9	N/C	No connection necessary. These pins may be connected to RF/DC ground.	
2, 4, 6, 10, 12, 13, 14, 16	GND	These pins must be connected to RF/DC ground.	
3	RF IN	This pin is matched to 50 Ohms with a 22 nH inductor to ground. See Application Circuit.	
7, 15	ACG	AC Ground - An external capacitor of 0.01µF to ground is required for low frequency bypassing. See Application Circuit for further details.	
	Vdd	Power supply voltage. Choke inductor and bypass capacitor are required. See application circuit.	
11	RF OUT	This pin is AC coupled and matched to 50 Ohms.	

Application Circuit

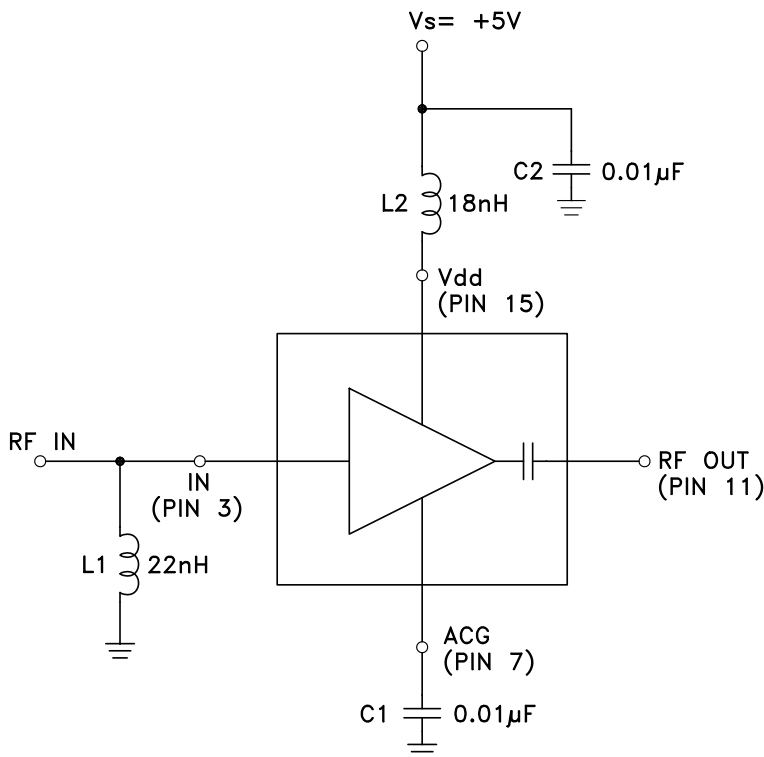

Note 1: Choose value of capacitor C1 for low frequency bypassing. A 0.01 µF ±10% capacitor is recommended.
 Note 2: L1, L2 and C1 should be located as close to the pins as possible.

Evaluation PCB

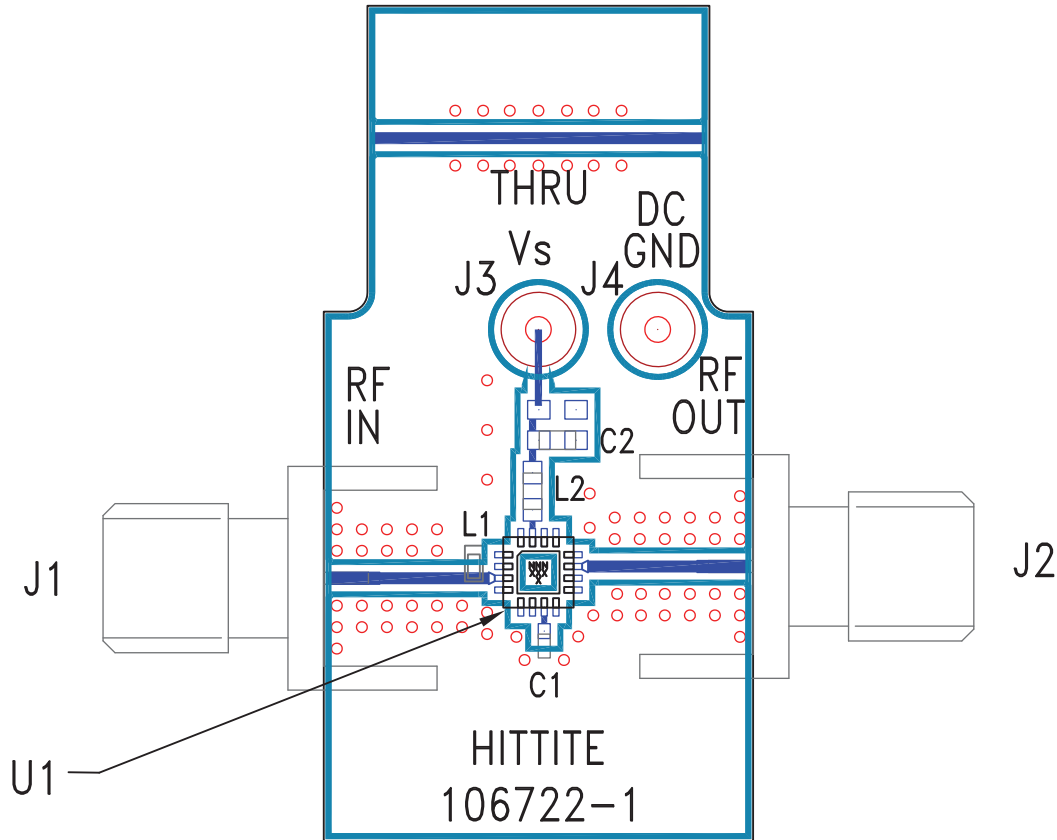

List of Materials for Evaluation PCB 106821 [1]

Item	Description
J1 - J2	PCB Mount SMA RF Connector
J3 - J4	DC Pin
C1	10000 pF Capacitor, 0402 Pkg.
C2	10000 pF Capacitor, 0060 Pkg.
L1	22nH Inductor, 0402 Pkg.
L2	18nH Inductor, 0603 Pkg.
U1	HMC372LP3 / HMC372LP3E Amplifier
PCB [2]	106722 Evaluation PCB

[1] Reference this number when ordering complete evaluation PCB

[2] Circuit Board Material: Rogers 4350

The circuit board used in the application should use RF circuit design techniques. Signal lines should have 50 Ohm impedance while the package ground leads and exposed paddle should be connected directly to the ground plane similar to that shown. A sufficient number of via holes should be used to connect the top and bottom ground planes. The evaluation circuit board shown is available from Hittite upon request.



Notes: