

Microstrip Isolators

Part Number: **KTMI-902A7**

Main Features:

- Frequency Range: 8.5GHz - 10.5GHz
- Small Size, Low Profile, Compact Design
- High Isolation, Low Insertion Loss
- Wide Operating Temperature : -40°C~+70°C
- Commercial, Military and Space Applications

Electrical Specifications at Room Temperature:

Part Number	Freq. Range (GHz)	Bandwidth Max. (MHz)	Insertion Loss Max. (dB)	Isolation Min. (dB)	VSWR Max.	Forward Power (W)	Reverse Power (W)
KTMI-902A7	8.5 - 10.5	full	0.5	18	1.30	2	1

Mechanical Dimensions (mm):

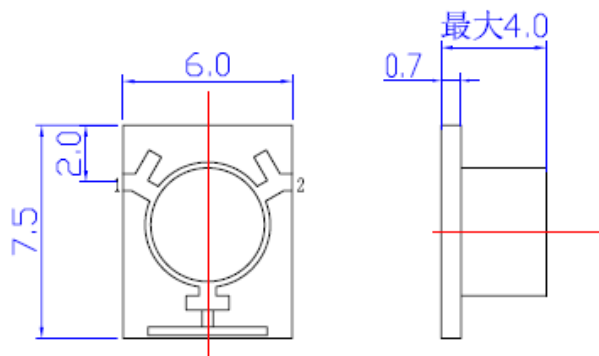

HOW TO ORDER

