

SMT GaAs MMIC x2 ACTIVE FREQUENCY MULTIPLIER, 20 - 25 GHz OUTPUT

Typical Applications

The HMC448LC3B is suitable for:

- Clock Generation Applications:
SONET OC-192 & SDH STM-64
- Point-to-Point & VSAT Radios
- Test Instrumentation
- Military & Space

Features

- Output Power: +11 dBm
- Wide Input Power Range: -4 to +6 dBm
- Fo, 3Fo Isolation: >20 dBc @ Fout= 20 GHz
- 100 KHz SSB Phase Noise: -135 dBc/Hz
- Single Supply: +5V@ 48 mA
- RoHS Compliant 3x3 mm SMT Package

Functional Diagram

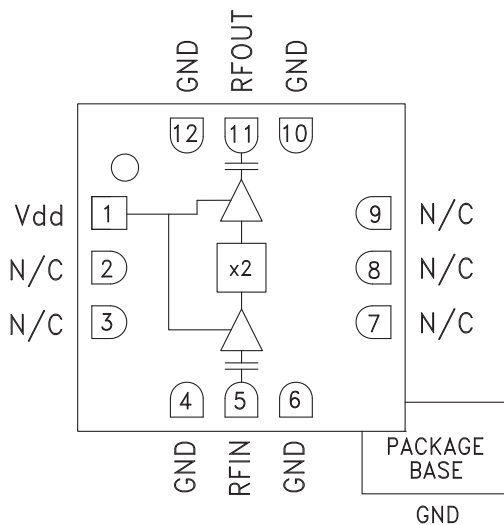

General Description

The HMC448LC3B is a x2 active broadband frequency multiplier utilizing GaAs PHEMT technology in a leadless RoHS compliant SMT package. When driven by a 0 dBm signal, the multiplier provides +11 dBm typical output power from 22 to 25 GHz. The Fo and 3Fo isolations are >20 dBc up to 22 GHz. This multi-rate frequency multiplier can be used in the generation of a half rate clock for 40 Gbps systems or as part of a multiplier chain to generate a full rate 40 Gbps clock. The HMC448LC3B is also ideal for use in LO multiplier chains for Pt to Pt & VSAT Radios yielding reduced parts count vs. traditional approaches. The low additive SSB Phase Noise of -135 dBc/Hz at 100 kHz offset helps maintain good system noise performance. The HMC448LC3B eliminates the need for wire bonding, allowing the use of surface mount manufacturing techniques.

Electrical Specifications, $T_A = +25^\circ C$, $V_{dd} = +5V$, 0 dBm Drive Level

Parameter	Min.	Typ.	Max.	Min.	Typ.	Max.	Units
Frequency Range, Input	10 - 11		11 - 12.5				GHz
Frequency Range, Output	20 - 22		22 - 25				GHz
Output Power	5	9		7.5	11		dBm
Fo Isolation (with respect to output level)		24			15		dBc
3Fo Isolation (with respect to output level)		25			25		dBc
Input Return Loss		10			7		dB
Output Return Loss		6			10		dB
SSB Phase Noise (100 kHz Offset)		-135			-135		dBc/Hz
Supply Current (I _{dd})		48			48		mA

SMT GaAs MMIC x2 ACTIVE FREQUENCY MULTIPLIER, 20 - 25 GHz OUTPUT



Output Power vs. Temperature @ 0 dBm Drive Level

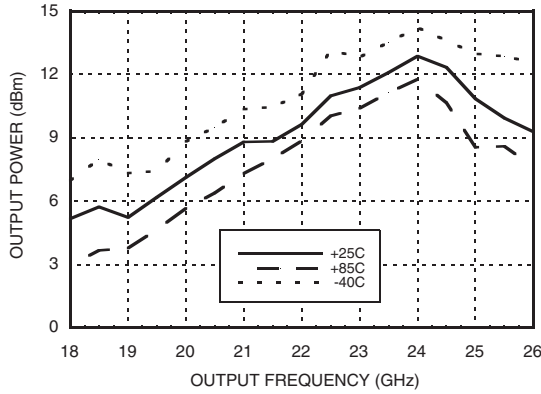

Output Power vs. Drive Level

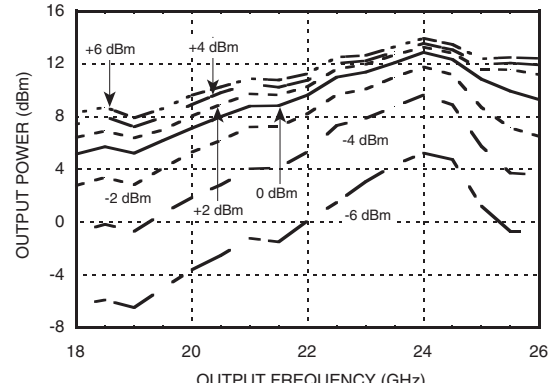

Output Power vs. Supply Voltage @ 0 dBm Drive Level

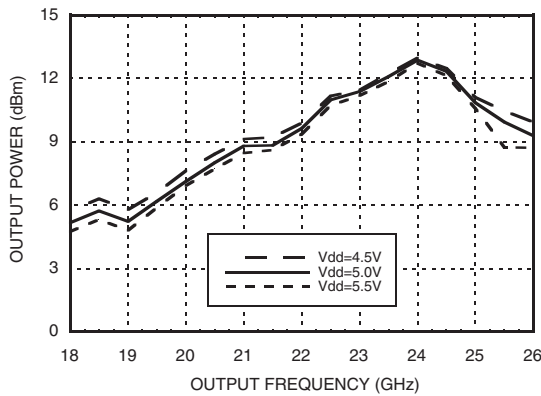

Isolation @ 0 dBm Drive Level

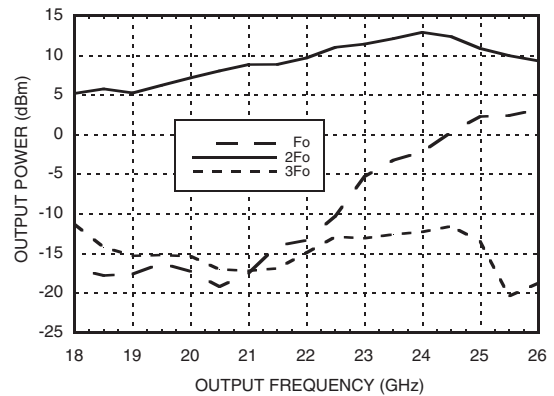

Pin vs. Pout @ 3 Frequencies

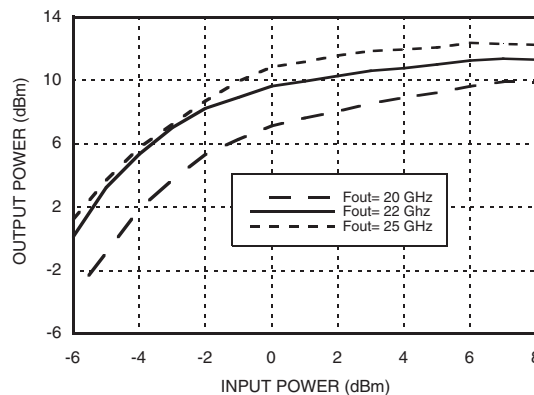



SMT GaAs MMIC x2 ACTIVE FREQUENCY MULTIPLIER, 20 - 25 GHz OUTPUT

7

FREQ. MULTIPLIERS - ACTIVE - SMT

Input Return Loss vs. Temperature

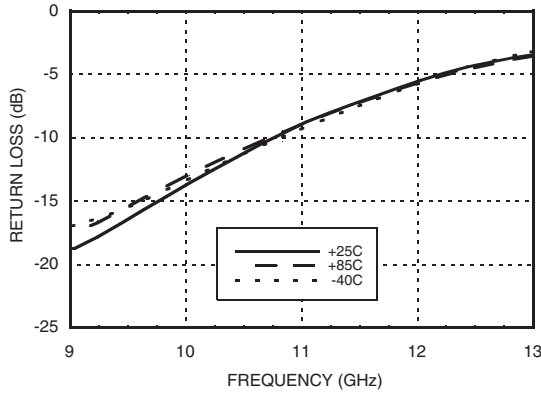

Output Return Loss vs. Temperature

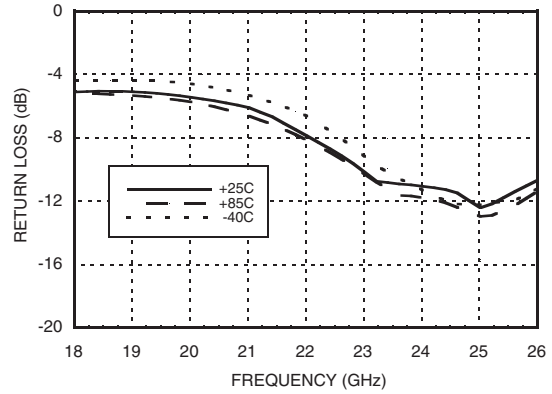

SSB Phase Noise Performance, Fout = 20.4 GHz, Pin = 0 dBm

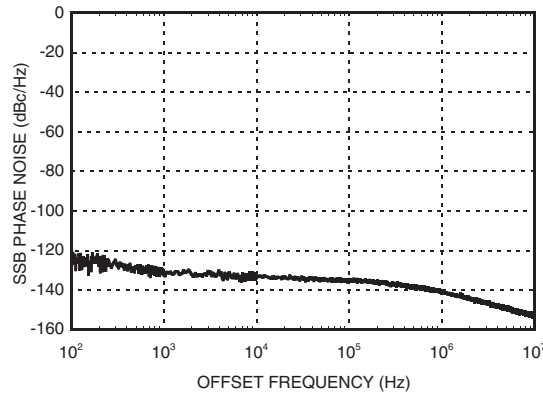

SMT GaAs MMIC x2 ACTIVE FREQUENCY MULTIPLIER, 20 - 25 GHz OUTPUT

Absolute Maximum Ratings

RF Input (Vcc= +5V)	+20 dBm
Supply Voltage (Vdd)	+6.0 Vdc
Channel Temperature	175 °C
Continuous Pdiss (T= 85 °C) (derate 8.3 mW/°C above 85 °C)	744 mW
Thermal Resistance (channel to ground paddle)	121 °C/W
Storage Temperature	-65 to +150 °C
Operating Temperature	-40 to +85 °C

Typical Supply Current vs. Vdd

Vdd (Vdc)	Idd (mA)
4.5	47
5.0	48
5.5	49

Note:
Multiplier will operate over full voltage range shown above.



ELECTROSTATIC SENSITIVE DEVICE
OBSERVE HANDLING PRECAUTIONS

Outline Drawing

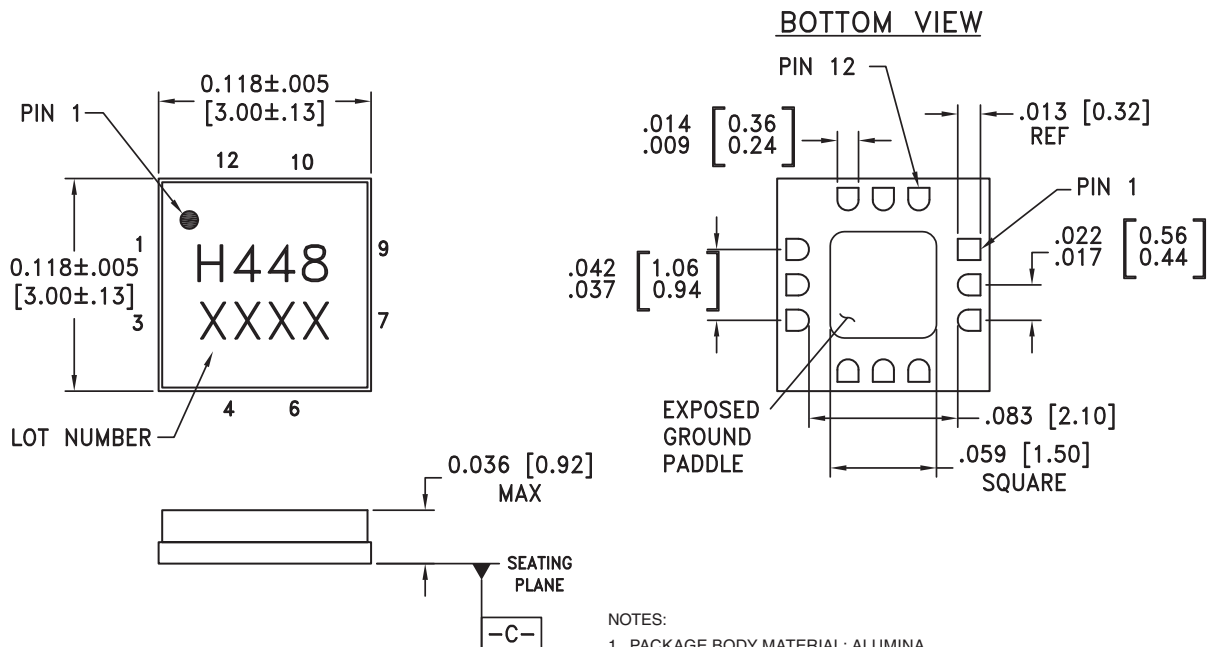



NOTES:

1. PACKAGE BODY MATERIAL: ALUMINA
2. LEAD AND GROUND PADDLE PLATING: 30-80 MICROINCHES GOLD OVER 50 MICROINCHES MINIMUM NICKEL.
3. DIMENSIONS ARE IN INCHES [MILLIMETERS].
4. LEAD SPACING TOLERANCE IS NON-CUMULATIVE
5. PACKAGE WARP SHALL NOT EXCEED 0.05mm DATUM **-C-**
6. ALL GROUND LEADS AND GROUND PADDLE MUST BE SOLDERED TO PCB RF GROUND.
7. CLASSIFIED AS MOISTURE SENSITIVITY LEVEL (MSL) 1.

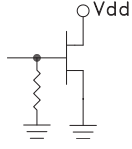

SMT GaAs MMIC x2 ACTIVE FREQUENCY MULTIPLIER, 20 - 25 GHz OUTPUT

Pin Description

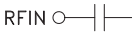
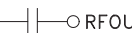
Pin Number	Function	Description	Interface Schematic
1	Vdd	Supply voltage $5V \pm 0.5V$. External bypass capacitors of 100 pF, 1,000 pF and 2.2 μF are required.	
2, 3, 7-9	N/C	This pin may be connected to RF/DC ground. Performance will not be affected.	
4, 6, 10, 12	GND	Package bottom must also be connected to RF/DC ground.	
5	RFIN	Pin is AC coupled and matched to 50 Ohm from 10.0 - 12.5 GHz.	
11	RFOUT	Pin is AC coupled and matched to 50 Ohm from 20 - 25 GHz.	

Application Circuit

Component	Value
C1	100 pF
C2	1,000 pF
C3	2.2 μF

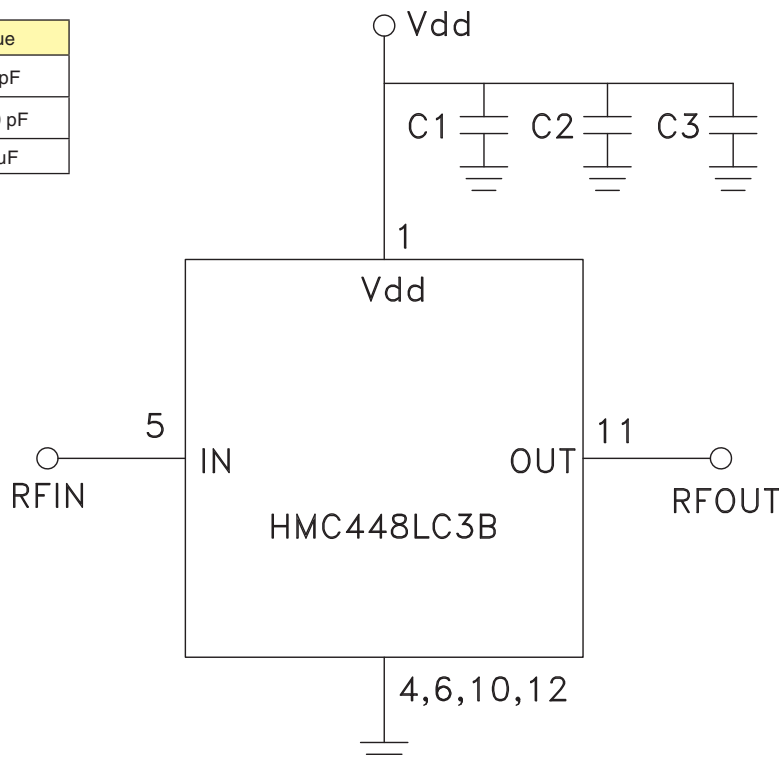

Evaluation PCB

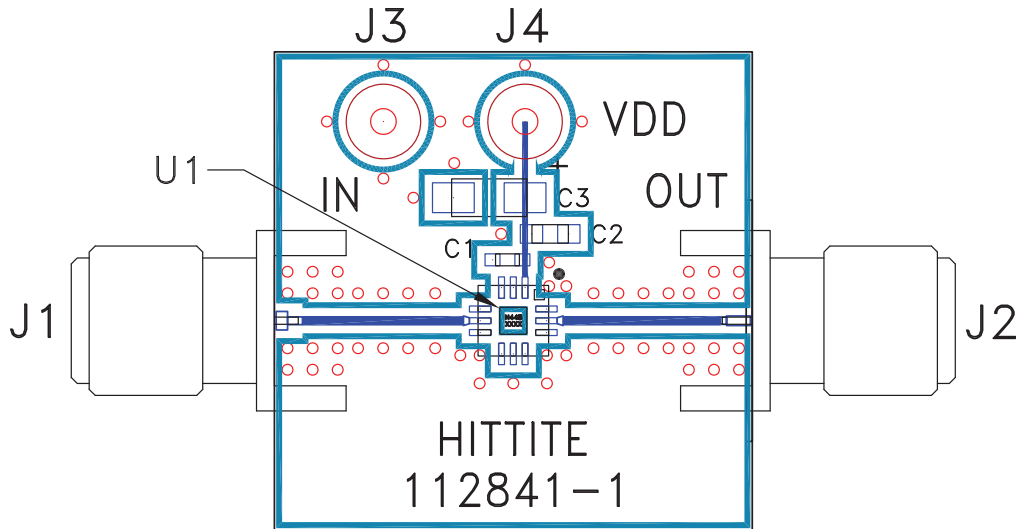

List of Materials for Evaluation PCB 112697 [1]

Item	Description
J1	PCB Mount SRI SMA Connector
J2	PCB Mount SRI K Connector
J3 - J4	DC Pin
C1	100 pF Capacitor, 0402 Pkg.
C2	1,000 pF Capacitor, 0603 Pkg.
C3	2.2 μ F Tantalum Capacitor
U1	HMC448LC3B x2 Active Multiplier
PCB [2]	112841 Eval Board

[1] Reference this number when ordering complete evaluation PCB

[2] Circuit Board Material: Rogers 4350

The circuit board used in the final application should be generated with proper RF circuit design techniques. Signal lines should have 50 ohm impedance while the package ground leads and exposed paddle should be connected directly to the ground plane similar to that shown. The evaluation circuit board shown is available from Hittite upon request.