

## GaAs pHEMT MMIC POWER AMPLIFIER, DC - 28 GHz

### Typical Applications

The HMC994ALP5E is ideal for:

- Test Instrumentation
- Microwave Radio & VSAT
- Telecom Infrastructure
- Military & Space
- Fiber optics

### Features

- P1dB Output Power: +27 dBm
- Psat Output Power: +29 dBm
- High Gain: 13 dB
- Output IP3: +38 dBm
- Supply Voltage: Vdd = +10V @ 250 mA
- 50 Ohm Matched Input/Output
- 32 Lead 5x5 mm SMT Package: 25 mm<sup>2</sup>

### Functional Diagram

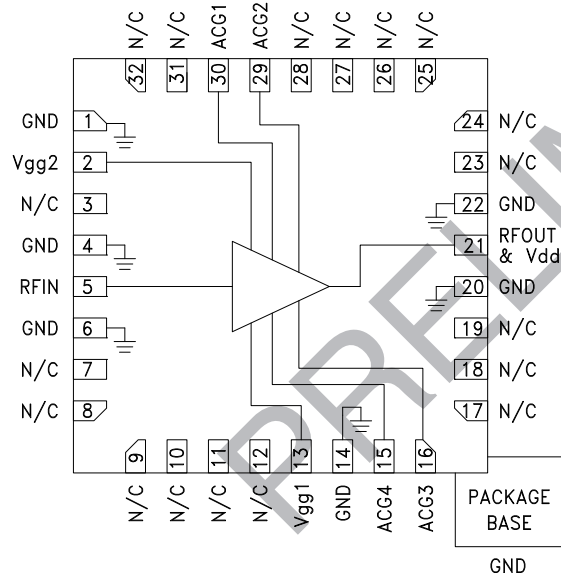

### General Description

The HMC994ALP5E is a GaAs pHEMT MMIC Distributed Wideband Power Amplifier which operates between DC and 28 GHz. The amplifier provides 13 dB of gain, +29 dBm of saturated output power, and 23% PAE from a +10V supply. With up to +38 dBm Output IP3 the HMC994ALP5E is ideal for high linearity applications in military and space as well as point-to-point and point-to-multi-point radios. The HMC994ALP5E exhibits a very flat gain from 4 to 16 GHz making it ideal for EW, ECM, Radar and test equipment applications. The HMC994LP4E amplifier I/Os are internally matched to 50 Ohms and is packaged in a leadless QFN 5x5 mm surface mount package.

### Electrical Specifications, $T_A = +25^\circ\text{C}$ , $V_{dd} = +10\text{V}$ , $V_{gg2} = +3.5\text{V}$ , $I_{dd} = 250\text{ mA}$ [1]

Parameter	Min.	Typ.	Max.	Min.	Typ.	Max.	Min.	Typ.	Max.	Units	
Frequency Range				DC - 10			10 - 20			20 - 28	GHz
Gain	11	13		11	13		11	13		dB	
Gain Flatness		±0.5			±0.5			±0.5		dB	
Gain Variation Over Temperature		0.008			0.011			1.016		dB/ °C	
Input Return Loss		18			15			12		dB	
Output Return Loss		18			16			12		dB	
Output Power for 1 dB Compression (P1dB)	26	28		24.5	27		22.5	25		dBm	
Saturated Output Power (Psat)		30			29.5			28		dBm	
Output Third Order Intercept (IP3) [2]		41			37			35		dBm	
Noise Figure		4			4			5		dB	
Total Supply Current		250	300		250	300		250	300	mA	

[1] Adjust Vgg1 between -2 to 0V to achieve Idd = 250 mA typical.

[2] Measurement taken at Pout / tone = +16 dBm.

## GaAs pHEMT MMIC POWER AMPLIFIER, DC - 28 GHz

### Pin Descriptions

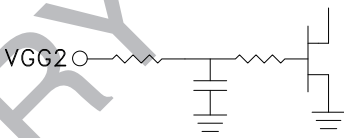
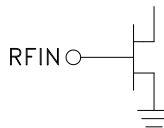
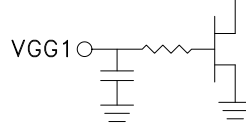
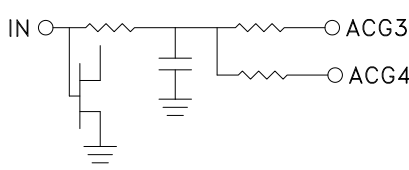
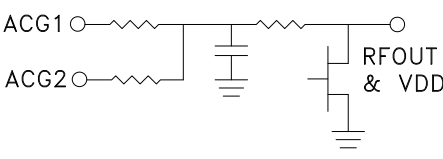
Pin Number	Function	Description	Interface Schematic
1, 4, 6, 14, 20, 22, Package Bottom	GND	These pins & exposed ground paddle must be connected to RF/DC ground.	
2	VGG2	Gate control 2 for amplifier. Attach bypass capacitor per application circuit herein. For nominal operation +3.5V should be applied to Vgg2	
3, 7, 8, 9, 10, 11, 12, 17, 18, 19, 23, 24, 25, 26, 27, 28, 31, 32	N/C	No connection required. These pins may be connected to RF/DC ground without affecting performance.	
5	RFIN	This pin is DC coupled and matched to 50 Ohms. Blocking capacitor is required.	
13	Vgg1	Gate control 1 for amplifier. Attach bypass capacitor per application circuit herein. Please follow "MMIC Amplifier Biasing Procedure" application note.	
15	ACG4	Low Frequency termination. Attach bypass capacitor per application circuit herein.	
16	ACG3		
21	RFOUT & Vdd	RF output for amplifier. Connect DC bias (Vdd) network to provide drain current (Idd). See application circuit herein.	
29	ACG2	Low frequency termination. Attach bypass capacitor per application circuit herein	
30	ACG1		

**GaAs pHEMT MMIC  
POWER AMPLIFIER, DC - 28 GHz**

**Outline Drawing**



**ELECTROSTATIC SENSITIVE DEVICE  
OBSERVE HANDLING PRECAUTIONS**

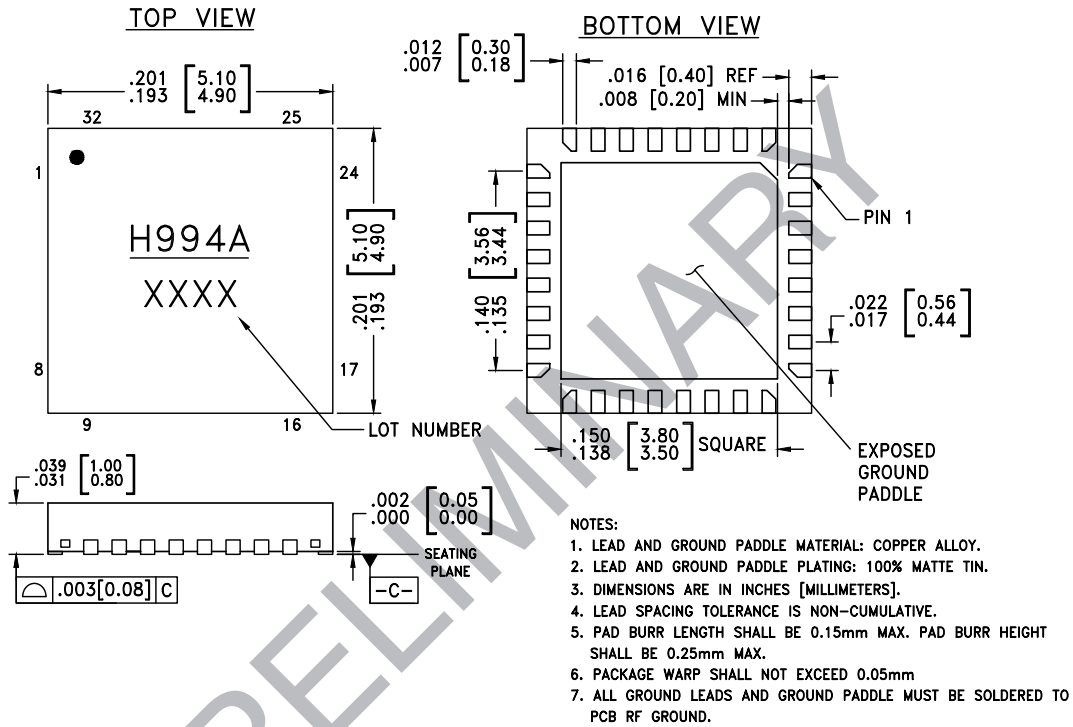

**Package Information**

Part Number	Package Body Material	Lead Finish	MSL Rating <sup>[2]</sup>	Package Marking <sup>[1]</sup>
HMC994ALP5E	RoHS-compliant Low Stress Injection Molded Plastic	100% matte Sn	MSL3	H994A XXXX

[1] 4-Digit lot number XXXX

[2] Max peak reflow temperature of 260 °C