

# Xinger®

## Ultra Low Profile 0805 Power Divider 50Ω to 50Ω

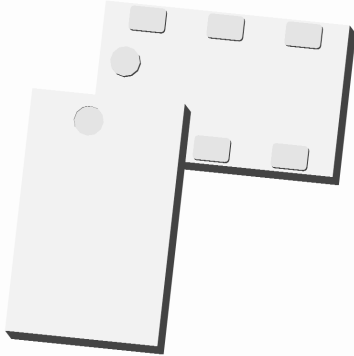

### Description

The PD3150J5050S2 is a low profile, sub-miniature Wilkinson power divider in an easy to use surface mount package. The PD3150J5050S2 is ideal for high volume manufacturing and delivers higher performances than traditional printed and lumped element solutions. The PD3150J5050S2 is matched to 50Ω and has a height profile of 0.5 mm which is ideal for high level integrations in the following markets: : DVB-S, GSM, DCS, PCS, WCDMA and GPS, 802.11a+g, Bluetooth, and Zigbee USA. The PD3150J5050S2 does not include the resistive element and therefore, requires an external resistor for operation. The PD3150J5050S2 is available on tape and reel for high volume manufacturing pick and place.

### Detailed Electrical Specifications: Specifications subject to change without notice.

Features:	Parameter	ROOM (25°C)			Unit
		Min.	Typ.	Max	
<ul style="list-style-type: none"> <li>• 3100-5000 MHz</li> <li>• 15 dB Isolation (output ports)</li> <li>• 0.5mm Height Profile</li> <li>• 50Ω Input / 50Ω Outputs</li> <li>• Low Insertion Loss</li> <li>• Surface Mountable</li> <li>• Tape &amp; Reel</li> <li>• Non-conductive Surface</li> <li>• RoHS Compliant</li> <li>• External Resistor required</li> </ul>	Frequency	3100		5000	MHz
	Input Port Impedance		50		Ω
	Output Port Impedance		50		Ω
	Return Loss	6.8	8.6		dB
	Insertion Loss*		1.0	1.3	dB
	Amplitude Balance		0.1	0.4	dB
	Phase Balance		1	2	Degrees
	Isolation (Output Ports)	13	15		dB
	Power Handling			2	Watts
	Operating Temperature		-55		+85

\* Insertion Loss stated at room temperature (Insertion Loss is approximately 0.1 dB higher at +85 °C)

### Outline Drawing

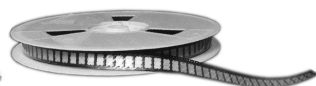
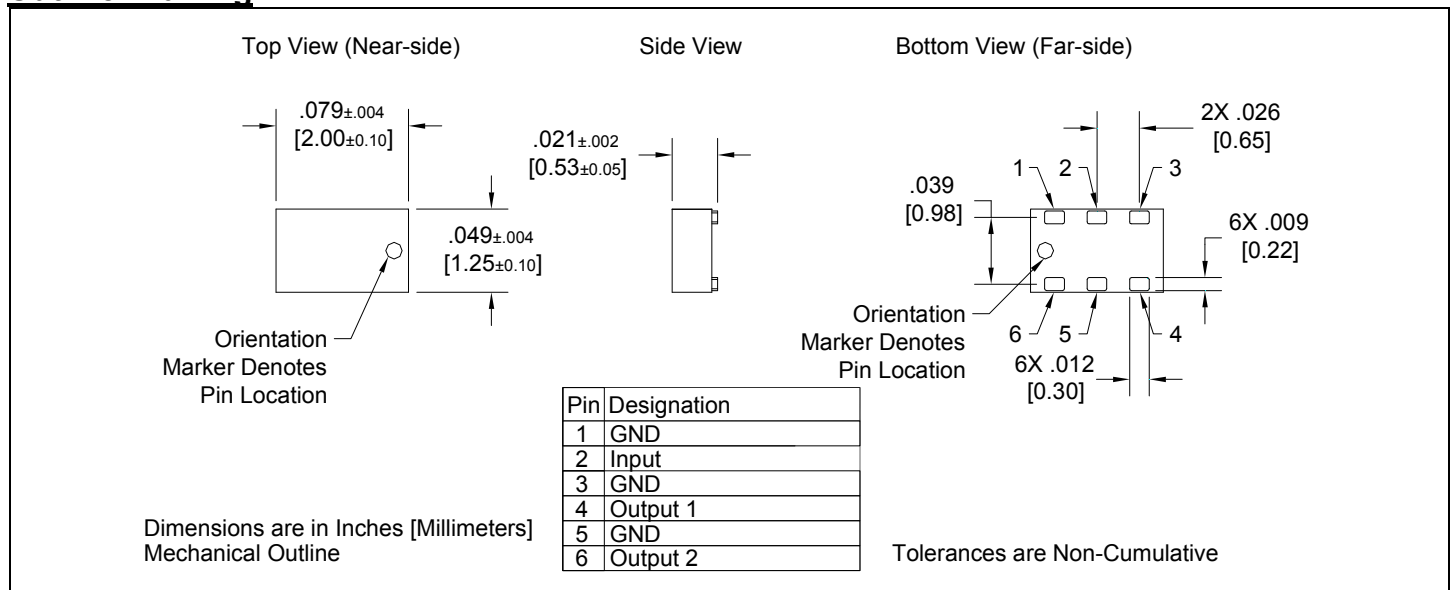

## Typical Broadband Performance: 500 MHz. to 8.0 GHz.

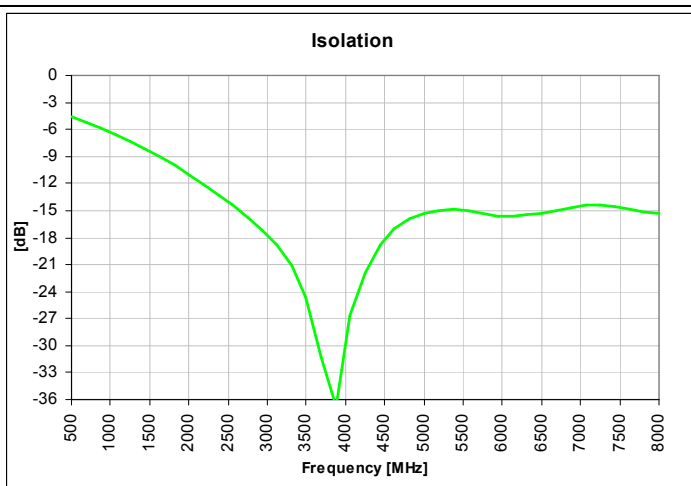
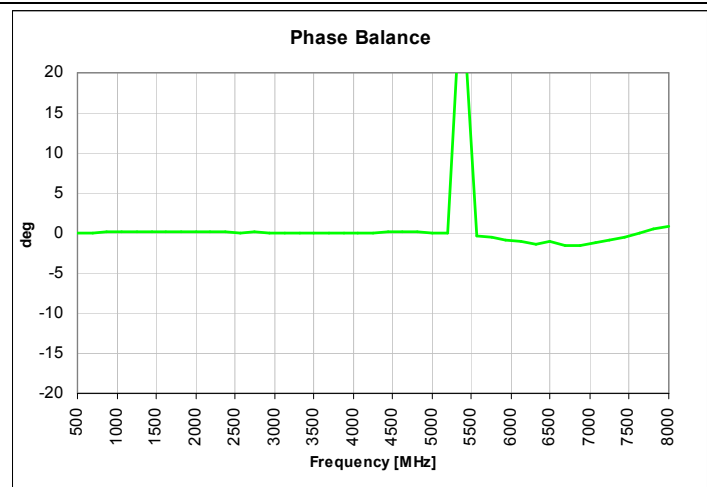
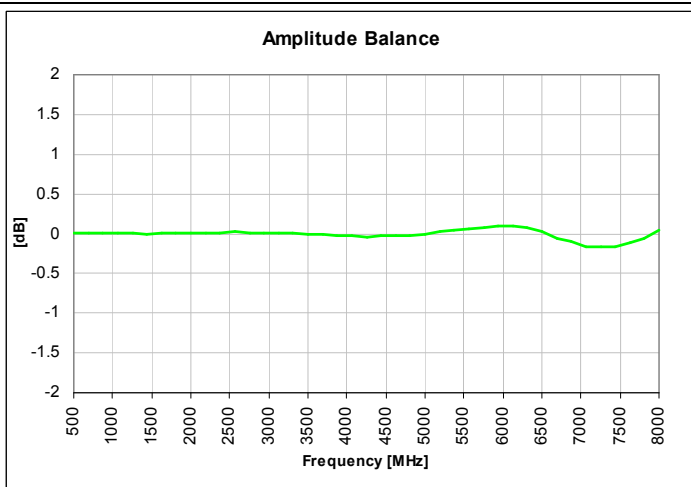
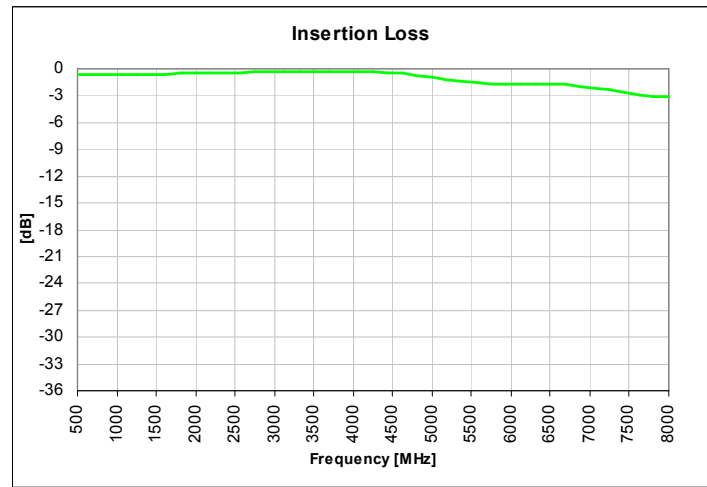
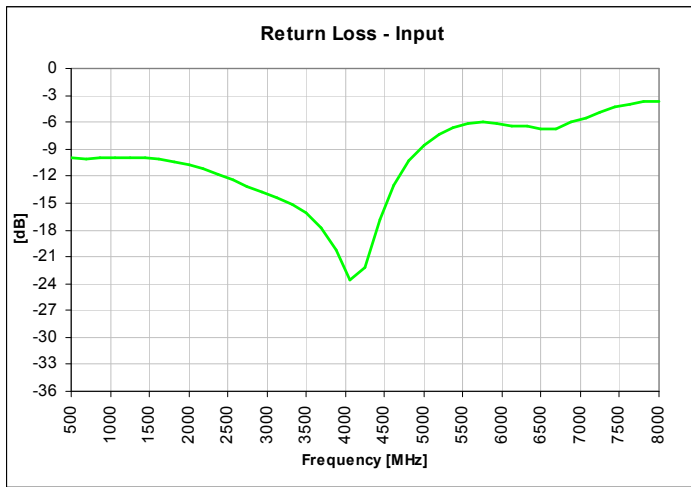

### Typical Performance: 3000 MHz. to 5100 MHz.

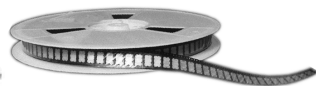
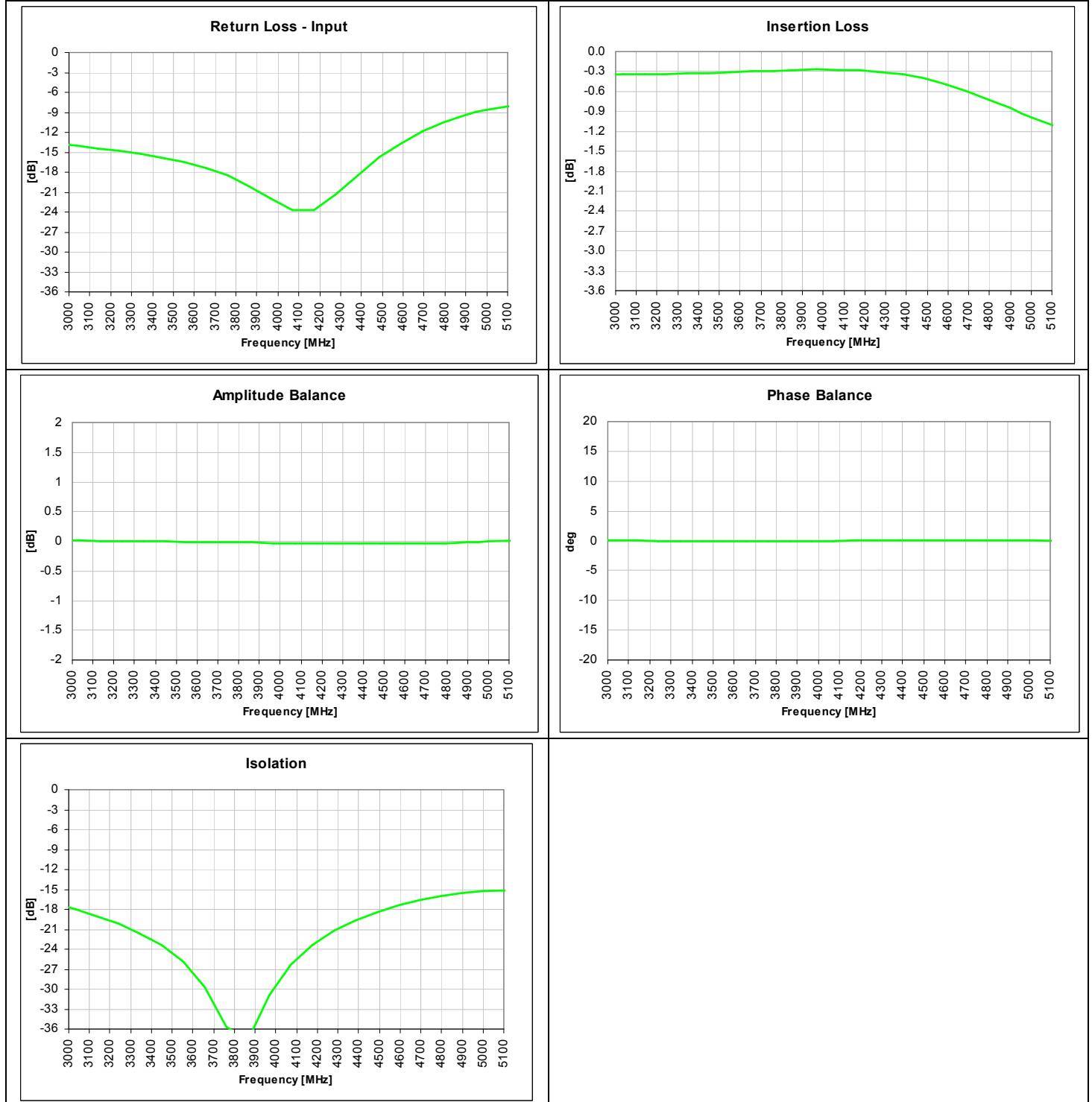

## Mounting Configuration:

In order for Xinger surface mount components to work optimally, the proper impedance transmission lines must be used to connect to the RF ports. If this condition is not satisfied, insertion loss, Isolation and VSWR may not meet published specifications.

An example of the PCB footprint used in the testing of these parts is shown below. In specific designs, the transmission line widths need to be adjusted to the unique dielectric coefficients and thicknesses as well as varying pick and place equipment tolerances. In addition, since the PD3150J5050S2 is a Wilkinson power divider, an external 0603 100Ω resistor must be mounted in locations R1 as shown in the Figure below.

All of the Xinger components are constructed from ceramic filled PTFE composites which possess excellent electrical and mechanical stability having X and Y thermal coefficient of expansion (CTE) of 17 ppm/°C.

### Pad Footprint w/ 0603 Resistor Locations

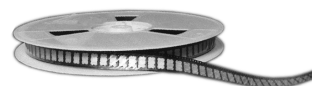
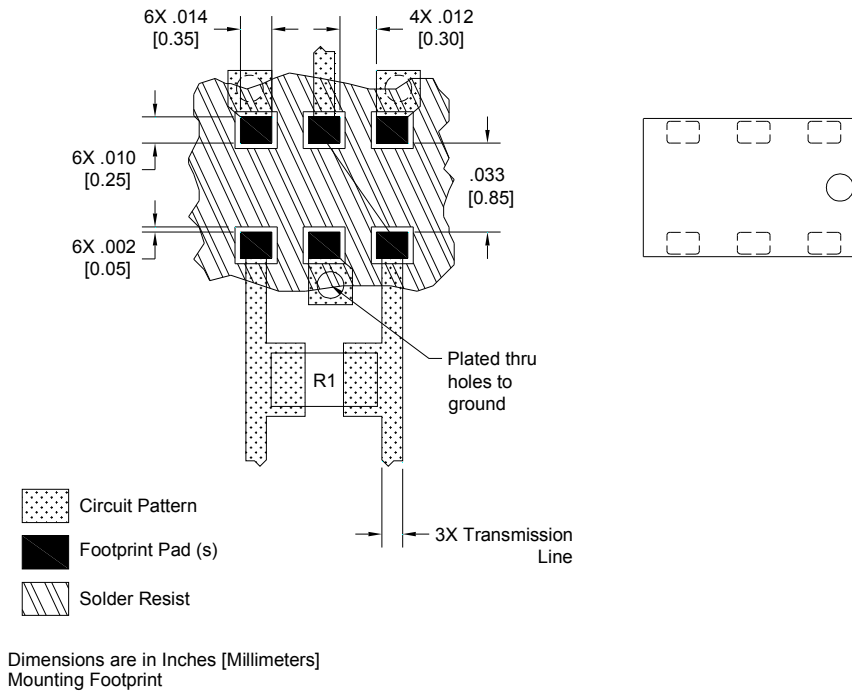

### Packaging and Ordering Information

Parts are available in reels and are packaged per EIA 481-2. Parts are oriented in tape and reel as shown below. Minimum order quantities are 4000 per reel. See Model Numbers below for further ordering information.

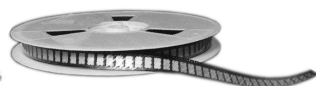
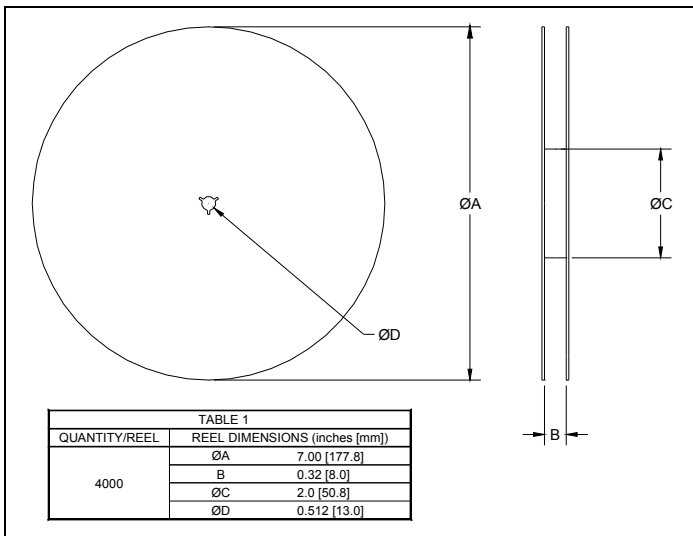
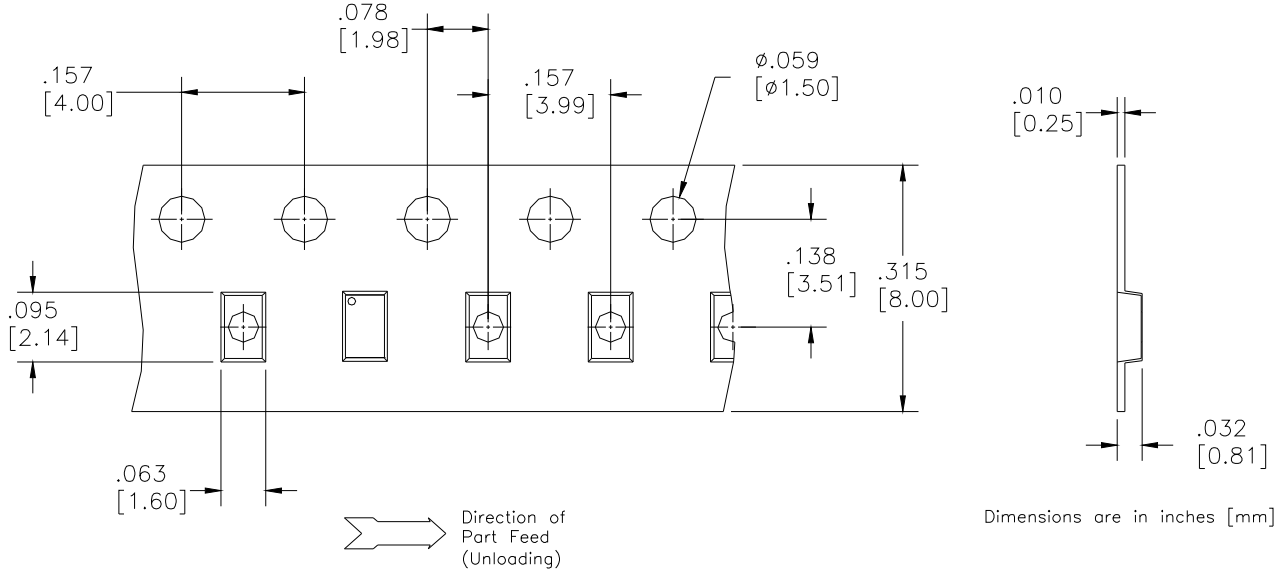

# BD 2425 J 50 100 A 00

Function	Frequency	Package Dimensions	Unbalanced Impedance	Balanced Impedance + Coupling	Plating Finish	Codes
<b>B = Balun</b>	0110 = 100 – 1000 MHz	<b>A = 150 x 150 mils</b>	50 = 50 Ohm	25 = 25 Ω Balanced	A = Gold	
<b>BD = Balun + DC</b>	0810 = 800 – 1000 MHz	(4mm x 4mm)	75 = 75 Ohm	30 = 30 Ω Balanced	P = Tin-Lead	
<b>F = Filter</b>	0922 = 950 – 2150 MHz	<b>C = 120 x 120 mils</b>		50 = 50 Ω Balanced		
<b>FB = Filter / Balun</b>	0826 = 800 – 6200 MHz	(3mm x 3mm)		75 = 75 Ω Balanced		
<b>C = 3dB Coupler</b>	1222 = 1200 – 2200 MHz	<b>E = 100 x 80 mils</b>		100 = 100 Ω Balanced		
<b>DC = Directional</b>	1416 = 1400 – 1600 MHz	(2.5mm x 2mm)		150 = 150 Ω Balanced		
<b>J = RF Jumper</b>	1722 = 1700 – 2200 MHz	<b>J = 80 x 50 mils</b>		200 = 200 Ω Balanced		
<b>X = RF cross over</b>	2326 = 2300 – 2600 MHz	(2mm x 1.25mm)		300 = 300 Ω Balanced		
	2425 = 2400 – 2500 MHz	<b>L = 60 x 30 mils</b>		400 = 400 Ω Balanced		
	3150 = 3100 – 5000 MHz	(1.5mm x 0.75mm)		03 = 3dB Hybrid		
	3436 = 3400 – 3600 MHz	<b>N = 40 x 40 mils</b>		10 = 10dB Directional		
	4859 = 4800 – 5900MHz	(1mm x 1mm)		20 = 20dB Directional		
	5153 = 5100 – 5300 MHz					
	5159 = 5100 – 5900 MHz					
	5759 = 5700 – 5900 MHz					

USA/Canada: (315) 432-8909  
 Toll Free: (800) 411-6596  
 Europe: +44 2392-232392

Available on Tape and Reel for Pick and Place Manufacturing.

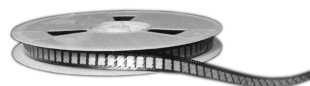

**Anaren**

What'll we think of next?™