

SPECIFICATION SHEET

SKYFR-001176: 2110—2170 MHz Single Junction Robust Lead Circulator

Applications

- Wireless infrastructure
- Power amplifiers



Features

- Very small surface mount package
- Operating frequency range: 2110 to 2170 MHz
- BeO free
- RoHS compliant
- Tape & Reel

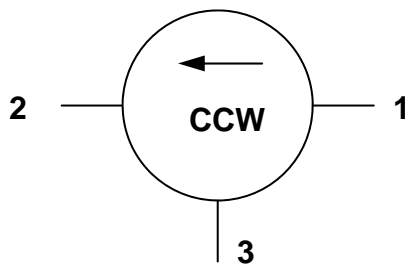
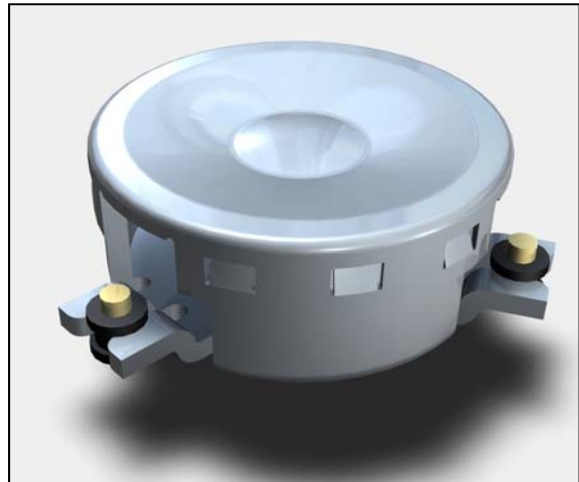

Figure 1. Block Diagram

Table 1. Absolute Maximum Ratings

Parameter	Symbol	Test Condition	Min	Max	Units
Average power	P_{AVG}			50	W
Peak power	P_{PK}			200	W
Operating temperature range	T_{OP}		-40	+100	°C
Storage temperature range	T_{STOR}		-55	+125	°C

Note: Exceeding any of the limits listed here may result in permanent damage to the device or may reduce device reliability.

SPECIFICATION SHEET • SKYFR-001176

Table 2. Electrical Specifications (Note 1)

Parameter	Symbol	Test Condition	Min	Typical	Max	Units
Frequency range	f		2110		2170	MHz
Impedance				50		Ω
Insertion loss	IL				0.20	dB
Isolation	ISO		23			dB
Return loss	RL		23			dB
2nd harmonic attenuation			10			dB
3rd harmonic attenuation			10			dB
Intermodulation distortion (Note 2)	IMD	2 x 15W CW tones, 5MHz spacing	60			dBc

Note 1: Performance is guaranteed under the conditions listed in this table and over the operating temperature range.

Note 2: See Skyworks Application Note, *Intermodulation Distortion Measurements of Ferrites*, document number 201537 for further details.

Note 3: Tested on PCB-00060, Rogers RO4350B, 20 mils thick, trace width 42 mils.

Table 3. Plating Specification

Section	Base Material	Plating
Pins	Brass	Silver
Housing	Steel	Silver

Table 4. Ordering Information

Manufacturing Part Number	Evaluation Board Part Number
SKYFR-001176	TFX-00118

SPECIFICATION SHEET • SKYFR-001176

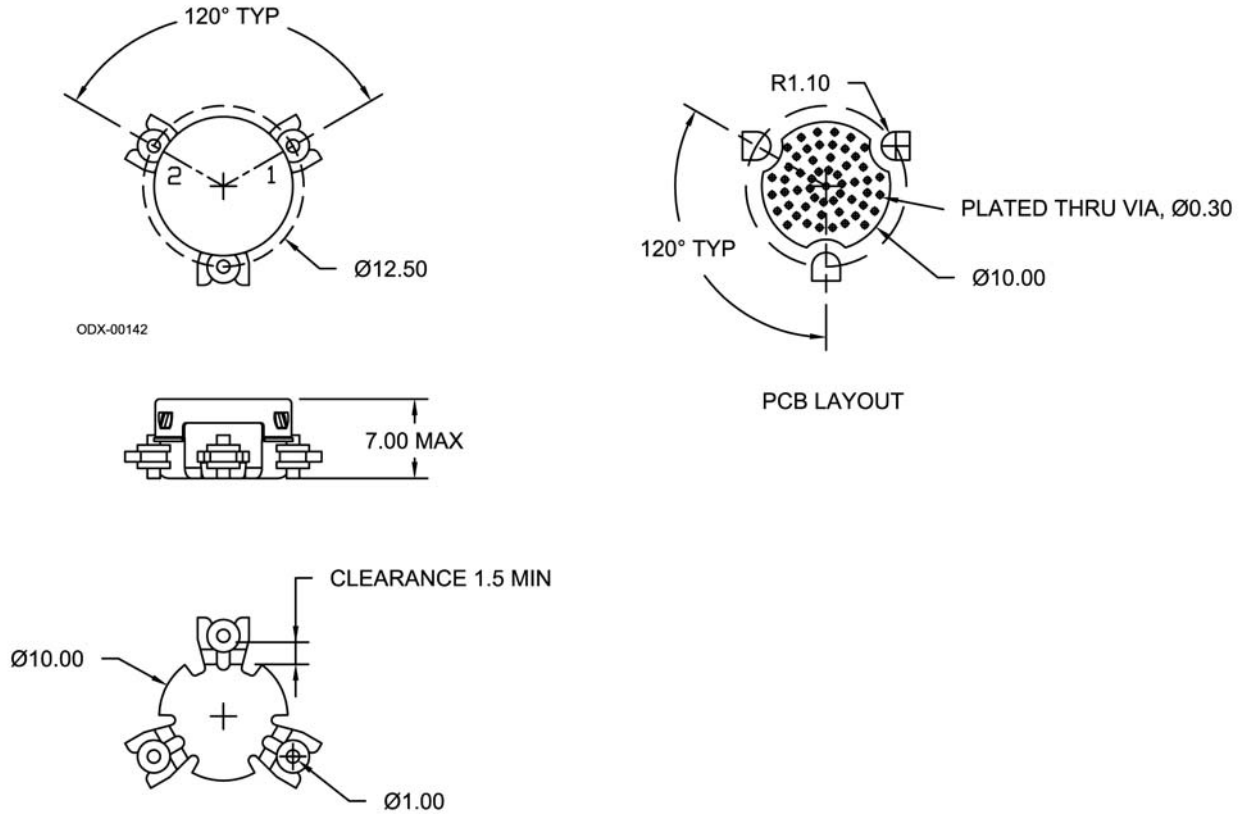

All dimensions in millimeters.
 Tolerance: $\pm 0.2\text{mm}$ unless otherwise specified.
 Coplanarity specification: 0.1mm maximum.
 Model number, lot code and part designation printed on top side of device.

Figure 2. Package Dimensions and Recommended PCB Layout

Copyright © 2011 Skyworks Solutions, Inc. All Rights Reserved.

Information in the document is provided in connection with Skyworks Solutions, Inc. ("Skyworks") products or services. These materials, including the information contained herein, are provided by Skyworks as a service to its customers and may be used for informational purposes only by the customer. Skyworks assumes no responsibility for errors or omissions in these materials or the information contained herein. Skyworks may change its documentation, products, services, specifications or product descriptions at any time, without notice. Skyworks makes no commitment to update the materials or information and shall have no responsibility whatsoever for conflicts, incompatibilities, or other difficulties arising from any future changes.

No license, whether express, implied, by estoppel or otherwise, is granted to any intellectual property rights by this document. Skyworks assumes no liability for any materials, products or information provided hereunder, including the sale, distribution, reproduction or use of any Skyworks products, information or materials, except as may be provided in Skyworks Terms and Conditions of Sale.

THE MATERIALS, PRODUCTS AND INFORMATION ARE PROVIDED "AS IS" WITHOUT WARRANTY OF ANY KIND, WHETHER EXPRESS, IMPLIED, STATUTORY, OR OTHERWISE, INCLUDING FITNESS FOR A PARTICULAR PURPOSE OR USE, MERCHANTABILITY, PERFORMANCE, QUALITY OR NON-INFRINGEMENT OF ANY INTELLECTUAL PROPERTY RIGHT; ALL SUCH WARRANTIES ARE HEREBY EXPRESSLY DISCLAIMED. SKYWORKS DOES NOT WARRANT THE ACCURACY OR COMPLETENESS OF THE INFORMATION, TEXT, GRAPHICS OR OTHER ITEMS CONTAINED WITHIN THESE MATERIALS. SKYWORKS SHALL NOT BE LIABLE FOR ANY DAMAGES, INCLUDING BUT NOT LIMITED TO ANY SPECIAL, INDIRECT, INCIDENTAL, STATUTORY, OR CONSEQUENTIAL DAMAGES, INCLUDING WITHOUT LIMITATION, LOST REVENUES OR LOST PROFITS THAT MAY RESULT FROM THE USE OF THE MATERIALS OR INFORMATION, WHETHER OR NOT THE RECIPIENT OF MATERIALS HAS BEEN ADVISED OF THE POSSIBILITY OF SUCH DAMAGE.

Skyworks products are not intended for use in medical, lifesaving or life-sustaining applications, or other equipment in which the failure of the Skyworks products could lead to personal injury, death, physical or environmental damage. Skyworks customers using or selling Skyworks products for use in such applications do so at their own risk and agree to fully indemnify Skyworks for any damages resulting from such improper use or sale.

Customers are responsible for their products and applications using Skyworks products, which may deviate from published specifications as a result of design defects, errors, or operation of products outside of published parameters or design specifications. Customers should include design and operating safeguards to minimize these and other risks. Skyworks assumes no liability for applications assistance, customer product design, or damage to any equipment resulting from the use of Skyworks products outside of stated published specifications or parameters.

Skyworks, the Skyworks symbol, and "Breakthrough Simplicity" are trademarks or registered trademarks of Skyworks Solutions, Inc. in the United States and other countries. Third-party brands and names are for identification purposes only, and are the property of their respective owners. Additional information, including relevant terms and conditions, posted at www.skyworksin.com and incorporated by reference.