



VOLTAGE CONTROLLABLE ATTENUATOR 2-18GHz

Features



- Wide Band Operation 2-18GHz
- High Power Handle Capability up to 100W upon request.
- Current control and low power consumption
- Low Insertion Loss and High dynamic range
- Temperature Range -55°C~+85°C
- Maximum voltage +50V DC.
- Customization available upon request

Reflective voltage Controllable Attenuator 2-18GHz

Reflective type attenuator						
Part Number	Frequency (GHz)	Insert. Loss (dB)	VSWR (Max:1)	Attenuation (dB)	Avg. Power Handling (Watts)	Current Control (mA)
RFVAT0218R30	2-18	2	2.0	30	0.2~100	15~20

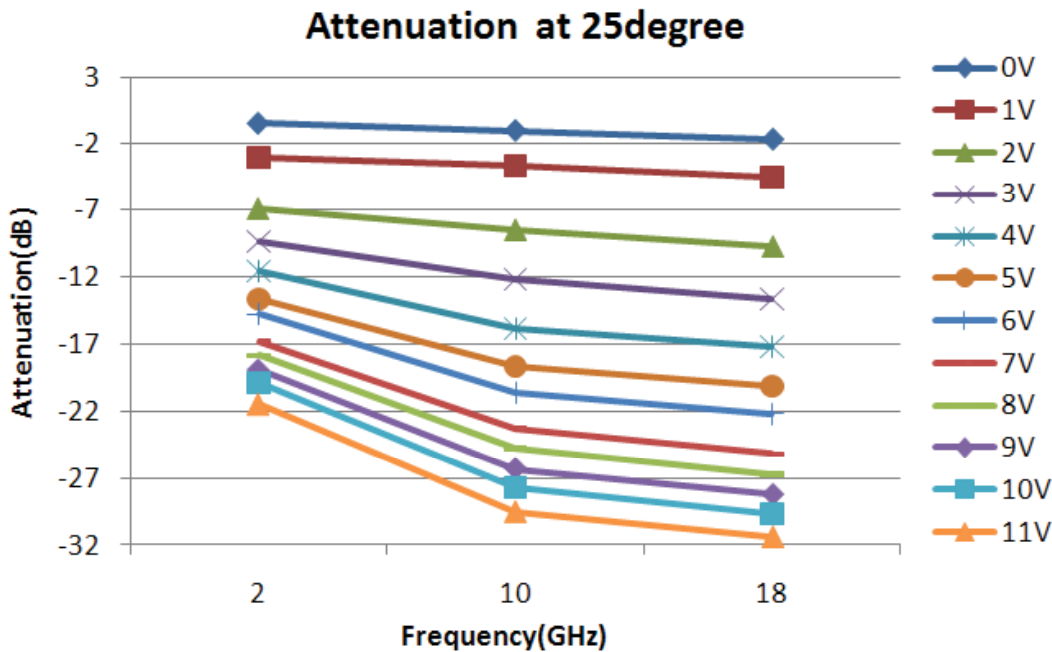

*standard unit with 220Ω internal current limiting resistor.
 *max. current 20mA

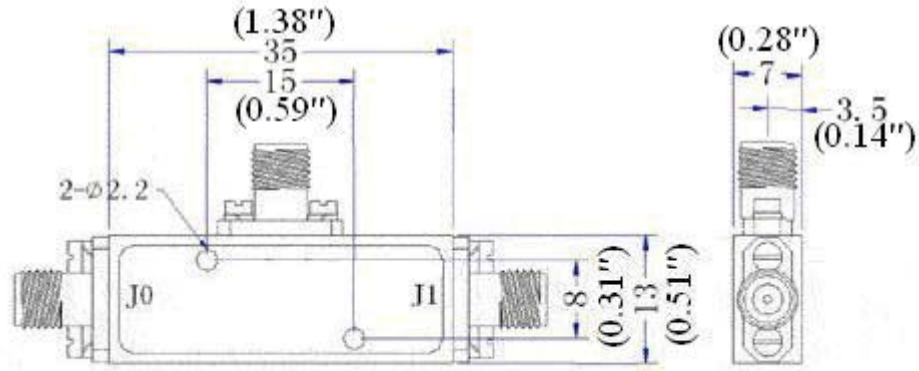

RAX01

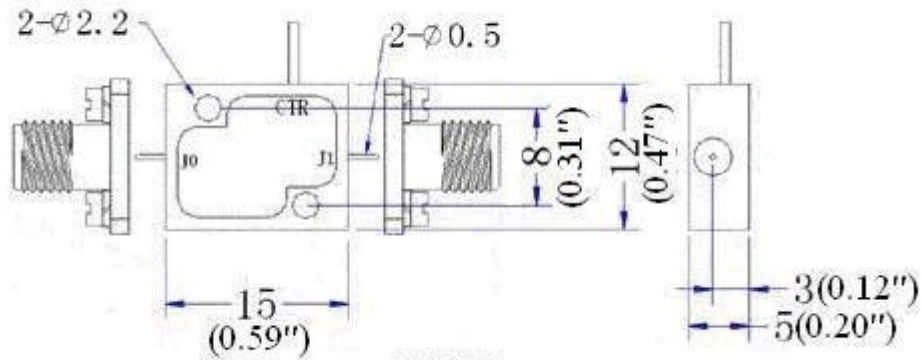

RAX02

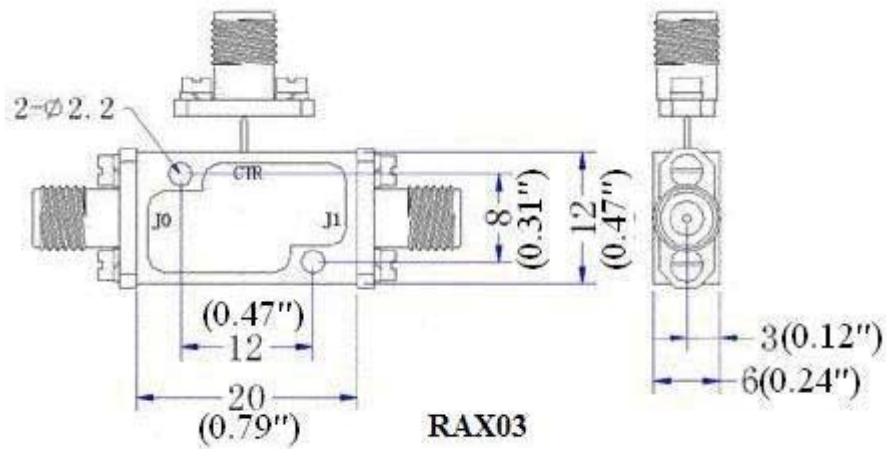

RAX03



RF-LAMBDA

The power beyond expectations

RFVAT0218R30

25 °C

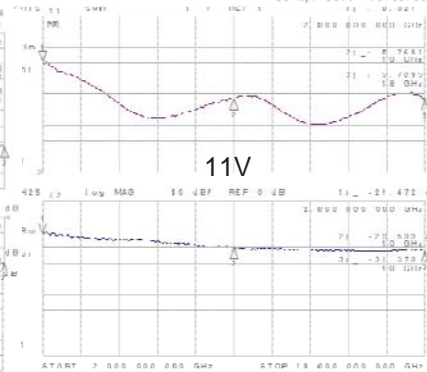
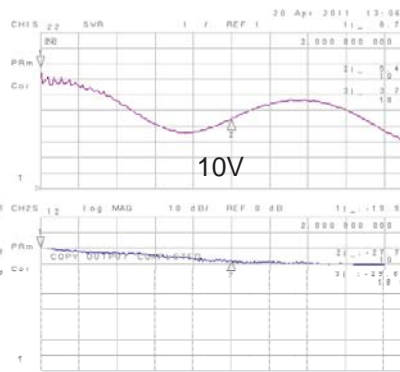
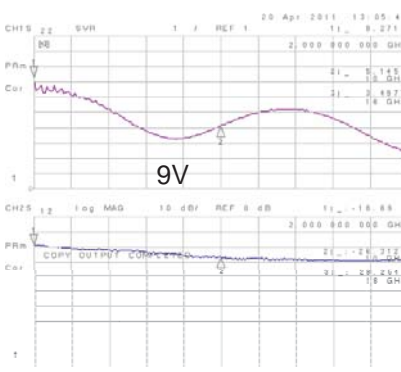
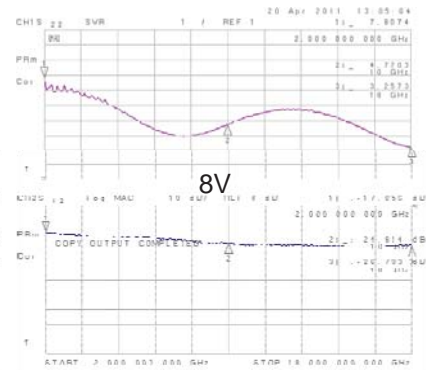
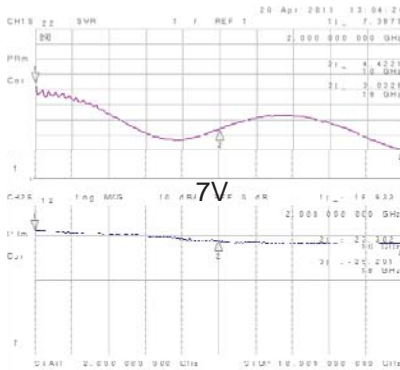
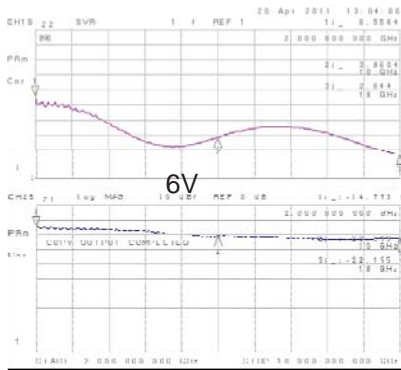
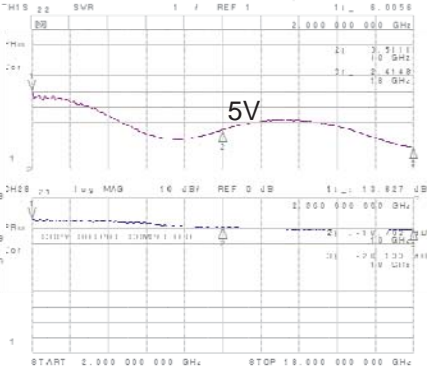
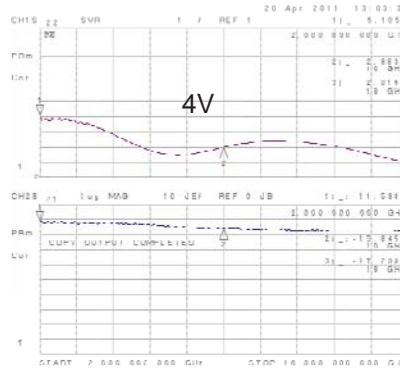
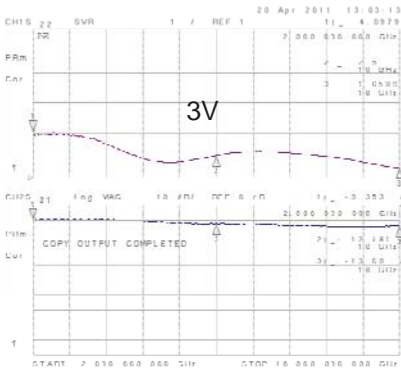
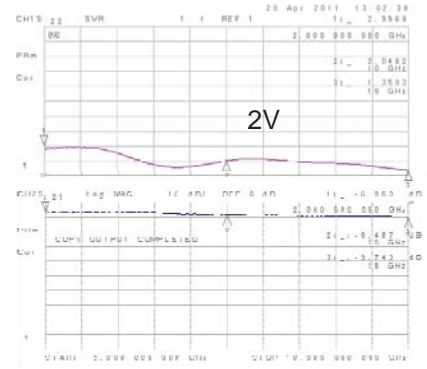
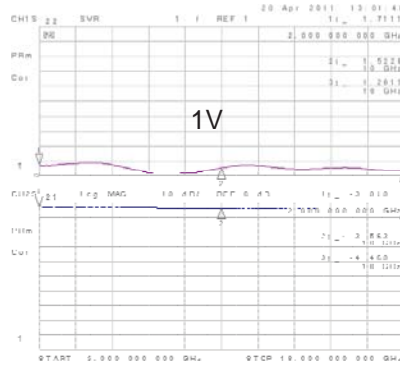
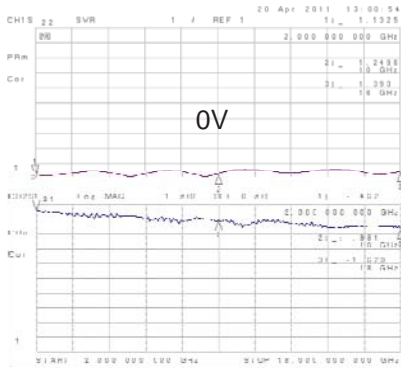

Reflective voltage Controllable Attenuator 2-18GHz



RF-LAMBDA

The power beyond expectations

RFVAT0218R30

-55 °C

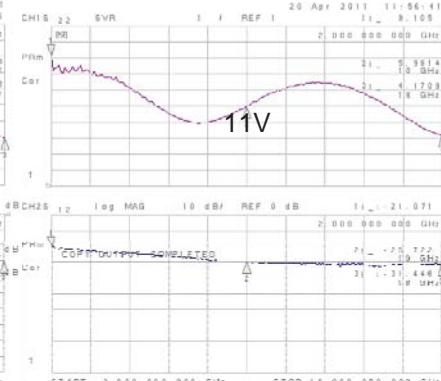
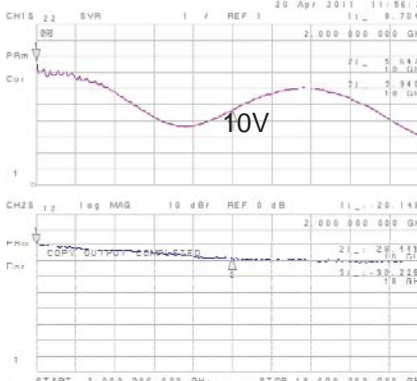
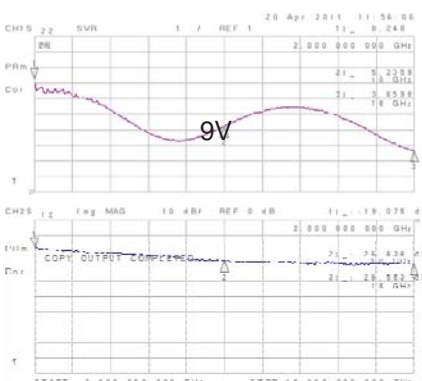
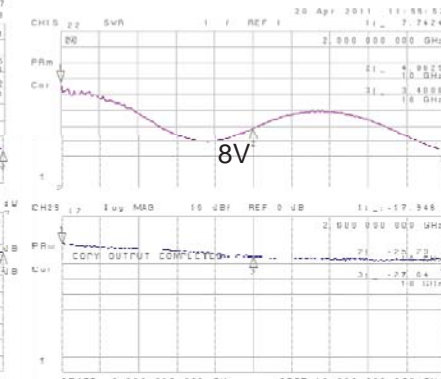
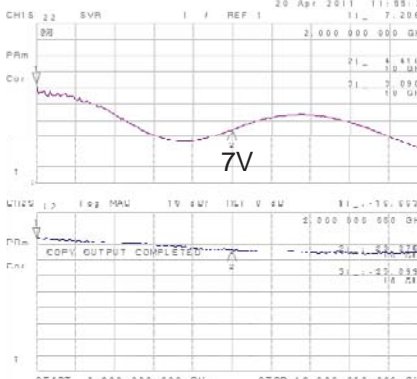
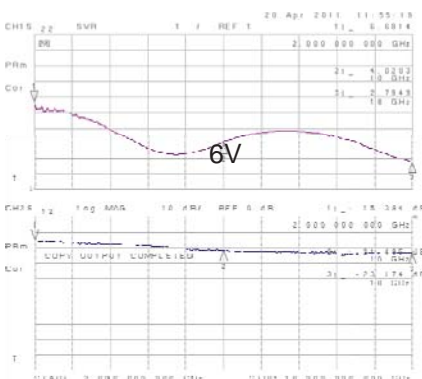
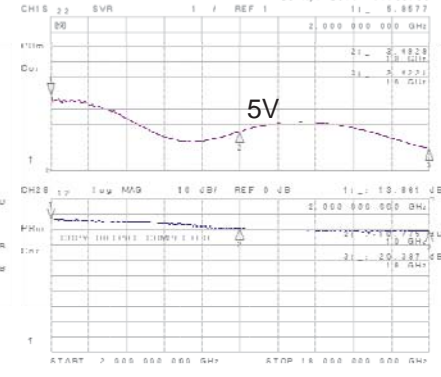
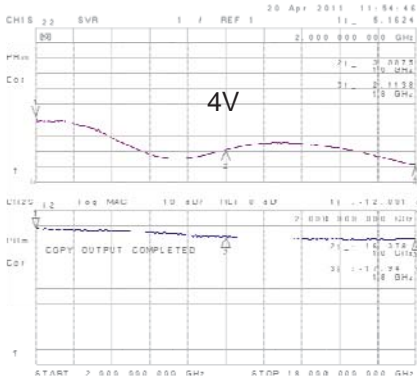
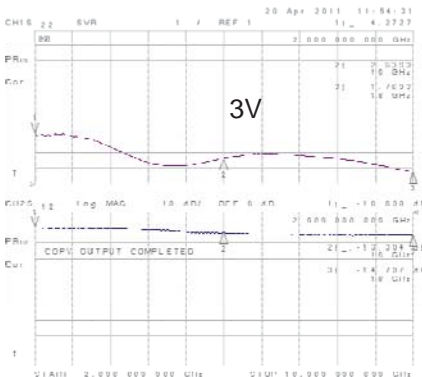
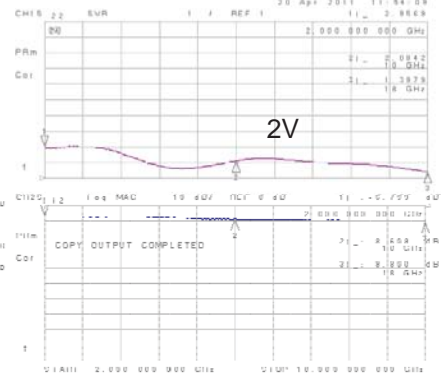
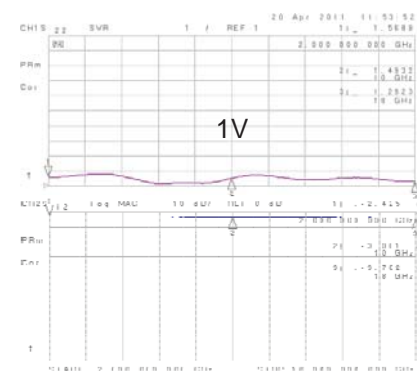
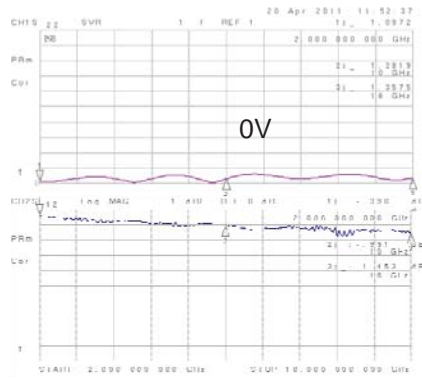

Reflective voltage Controllable Attenuator 2-18GHz



RF-LAMBDA

The power beyond expectations

RFVAT0218R30

Reflective voltage Controllable Attenuator 2-18GHz

-55 °C

