

Features:

- Multi-Octave bandwidth, specification from 1.0~4.0GHz
- Low noise figure, and high gain
- Low VSWR, unconditional stable
- Small size, low cost
- SMA female connector I/O
- Single DC power supply, internal voltage regulator
- Operating temperature -40~+75°C, storage temperature -55~+125°C

Electrical Specifications

Parameters	Specifications		
	Minimum	Typical	Maximum
Frequency Range	1000 MHz		4000MHz
Noise Figure (from 50MHz)		1.5 dB	1.8 dB
Nominal SS Gain @25°C	35 dB	37dB	39 dB
Gain flatness		+/-0.75 dB	+/-1.0 dB
Gain Variation Over Temperature		+/-1.0 dB	
P-1dB Compression Point	+14.0dBm	+15.0 dBm	
Output IP3	+23.0 dBm	+28.0 dBm	
Input VSWR		1.7:1	2.0:1
Output VSWR		1.7:1	2.0:1
Reverse Isolation		50dB	
Spurious			-60 dBc
Operating Temperature	-40°C		+85°C
Survival Temperature	-55°C		+125°C
DC Voltage	+10.5	+12 V	+13.5
DC Supply Current	100 mA	120 mA	150 mA
RF In/Out connectors	SMA female		
DC Input Connector	Feed-thru PIN		
Size	1.5"x0.85"x0.375		

Functional Diagram

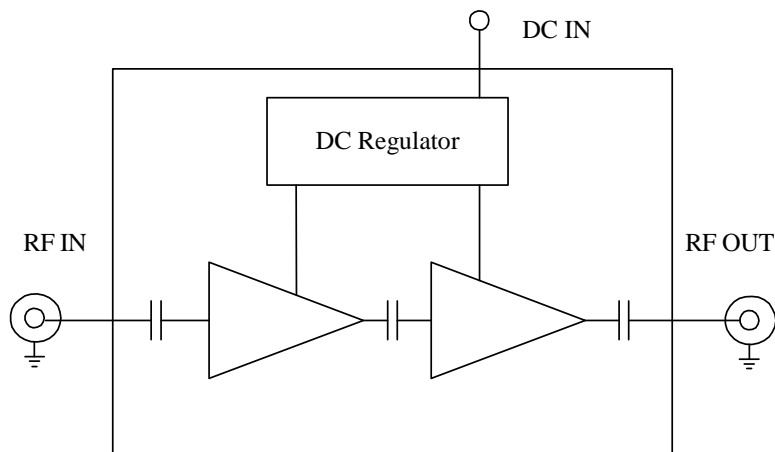

Mechanical Structure:

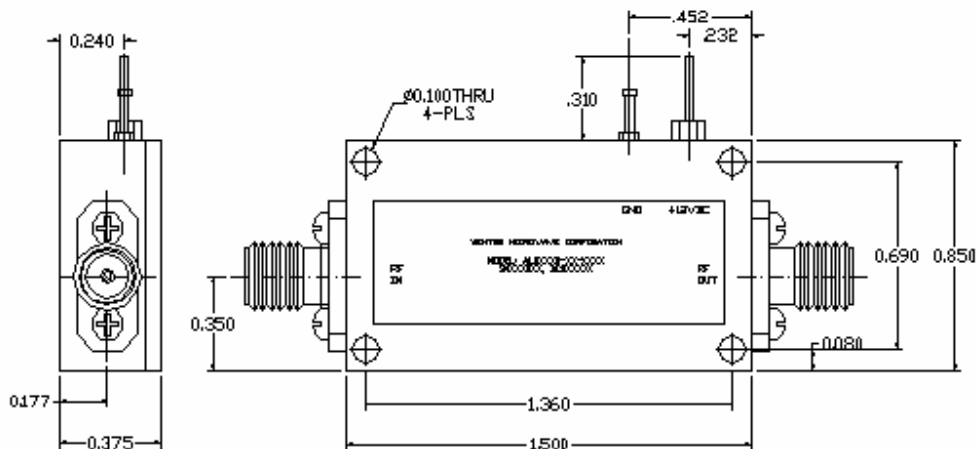

Note: All units in inches.

Typical Test Results:

ABL0400-25-3715 Measured Gain and Return Loss vs Frequency

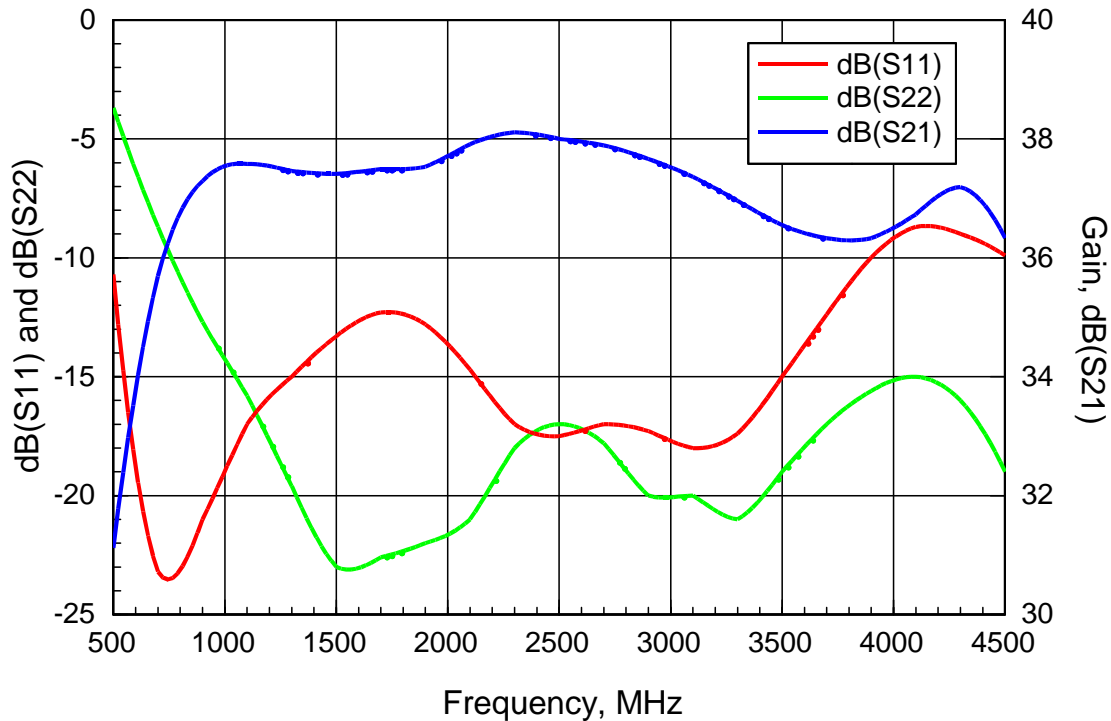

ABL0400-25-3715 Measured Noise Figure vs Frequency

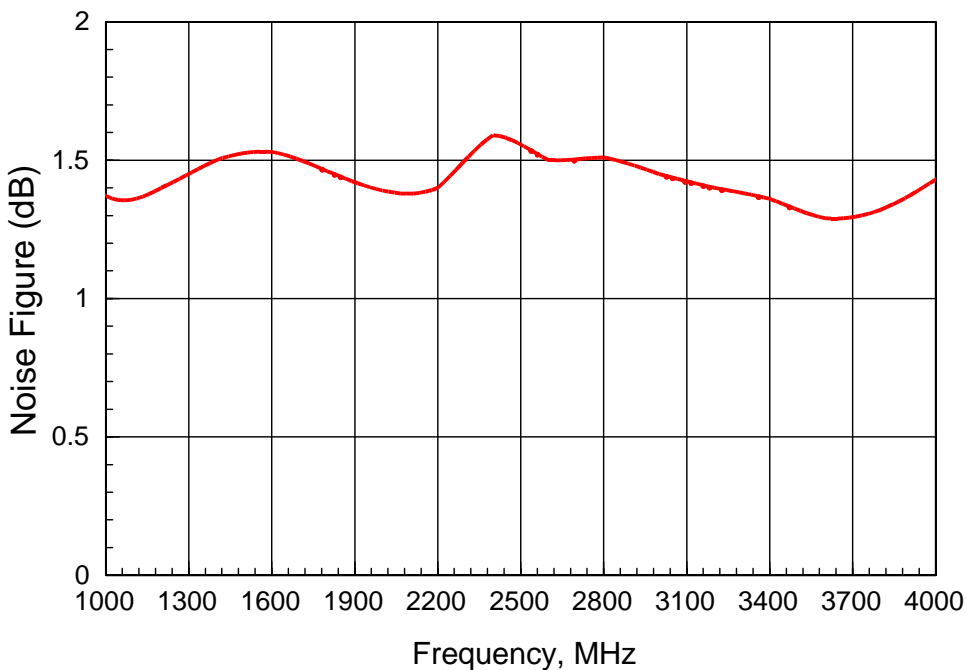

ABL0400-25-3715 Measured Gain and Output Power vs Input Power
Test Frequency: 1000MHz

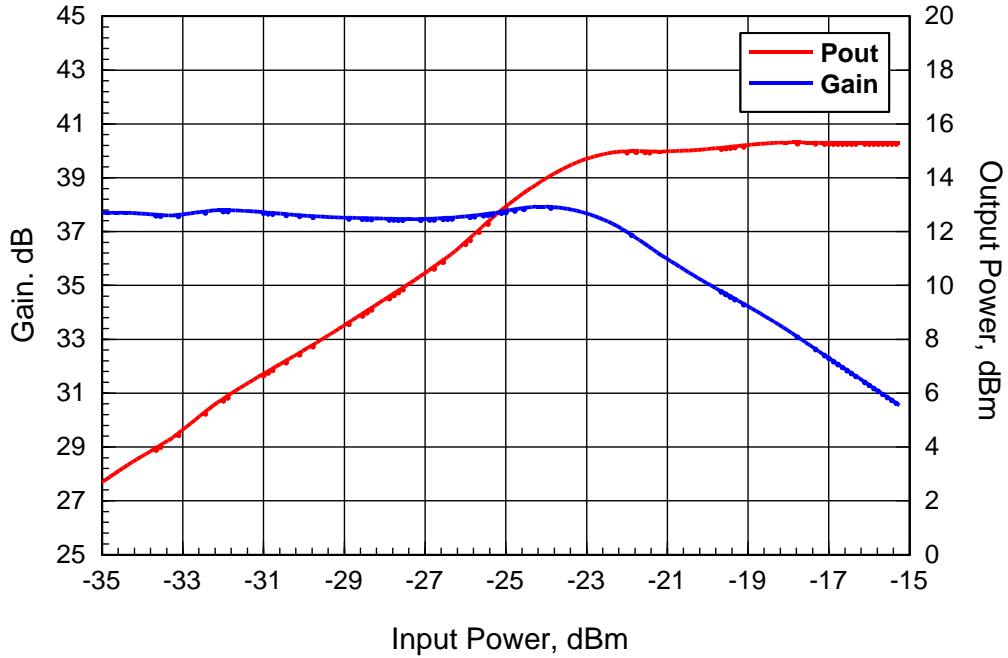

ABL0400-25-3715 Measured Gain and Output Power vs Input Power
Test Frequency: 2500MHz

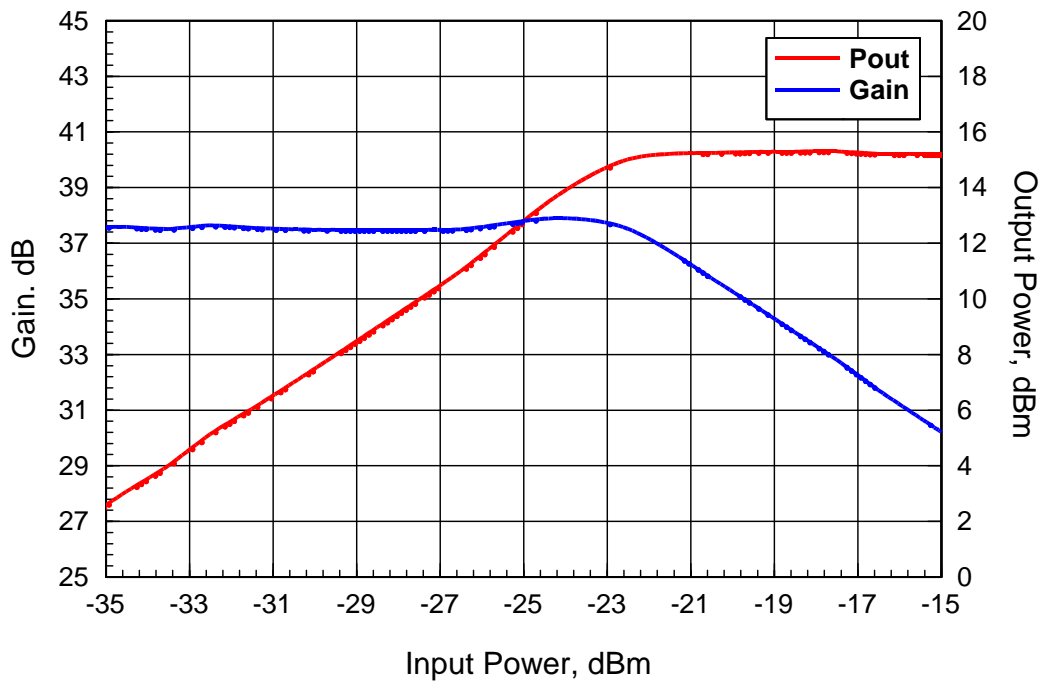

ABL0400-25-3715 Measured Gain and Output Power vs Input Power
Test Frequency: 4000MHz

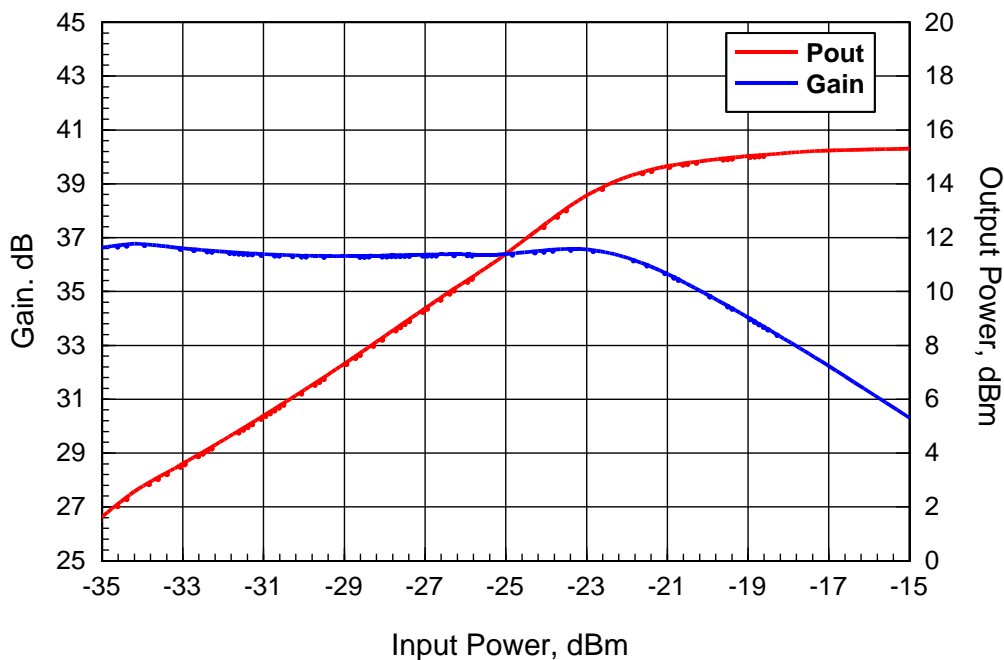

Absolute Maximum Ratings

DC Voltage	+15V
RF Input Power	+18dBm
Storage Temperature	-55~+125°C
Operating Temperature	-40~+75°C