

Analog Devices Welcomes Hittite Microwave Corporation

NO CONTENT ON THE ATTACHED DOCUMENT HAS CHANGED



THIS PAGE INTENTIONALLY LEFT BLANK

SINGLE STAGE POWER AMPLIFIER MODULE, 10 MHz - 6 GHz

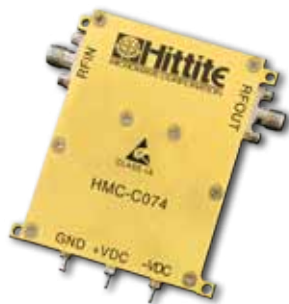

Typical Applications

The HMC-C074 is ideal for:

- Telecom Infrastructure
- Test Instrumentation
- Military & Space

Functional Diagram

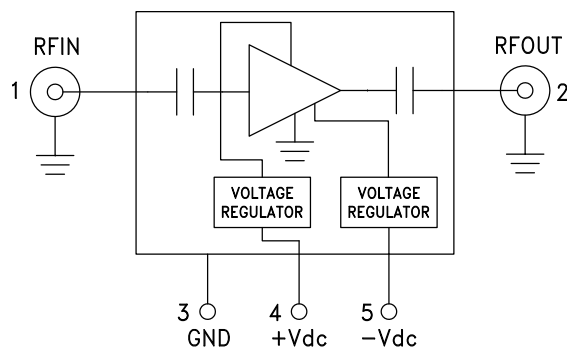

Features

- Gain: 13 dB
- High P1dB Output Power: +29.5 dBm
- High Output IP3: +40 dBm
- Excellent Gain Flatness: ± 0.75 dB
- Regulated Supply and Bias Sequencing
- Field Replaceable SMA Connectors
- Operating Temperature: -40°C to $+70^{\circ}\text{C}$

General Description

The HMC-C074 is a Single Stage Power Amplifier which operates between 10 MHz and 6 GHz. The amplifier provides 13 dB of gain, +40 dBm output IP3 and +29.5 dBm of output power at 1 dB gain compression while consuming only 450 mA from a +15V supply. Gain flatness is excellent at ± 0.75 dB from 10 MHz - 6 GHz making the HMC-C074 ideal for EW, ECM, Radar and test equipment applications. The amplifier I/Os are internally matched to 50 Ohms and are DC blocked. Integrated voltage regulators allow for flexible biasing of both the negative and positive supply pins, while internal bias sequencing circuitry allows robust operation.

Electrical Specifications, $T_A = +25^{\circ}\text{C}$, $-V_{dc} = -5\text{V}$, $+V_{dc} = 15\text{V}$

Parameter	Min.	Typ.	Max.	Units
Frequency Range	0.01 - 6			GHz
Gain	11.5	13		dB
Gain Flatness		± 0.75		dB
Gain Variation Over Temperature		0.02		dB/ $^{\circ}\text{C}$
Input Return Loss		17		dB
Output Return Loss		17		dB
Output Power for 1 dB Compression (P1dB)	27.5	29.5		dBm
Saturated Output Power (Psat)		30		dBm
Output Third Order Intercept (IP3)		40		dBm
Noise Figure		5		dB
Supply Current (+15V)		450	500	mA
Supply Current (-5V)		5		mA

**SINGLE STAGE POWER AMPLIFIER
MODULE, 10 MHz - 6 GHz**



Gain & Return Loss

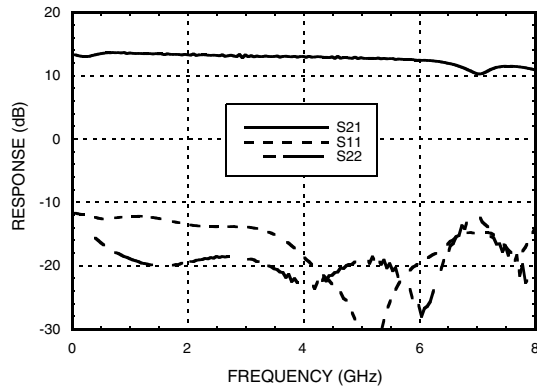

Gain vs. Temperature

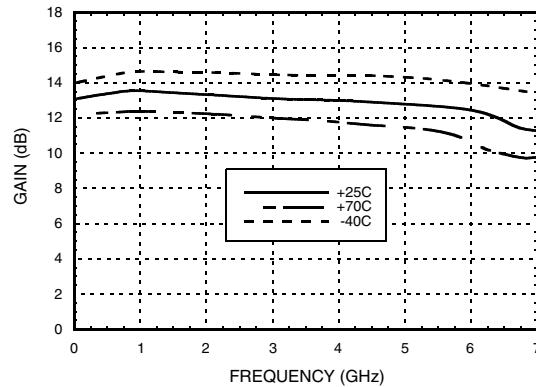

Input Return Loss vs. Temperature

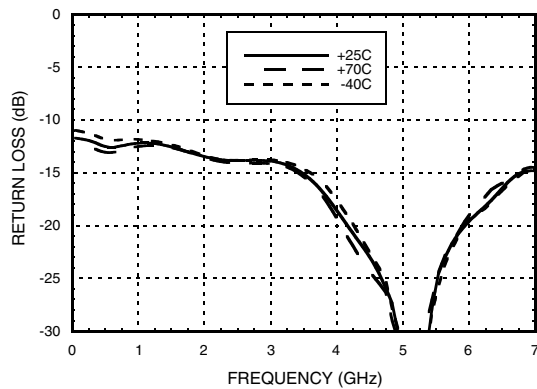

Output Return Loss vs. Temperature

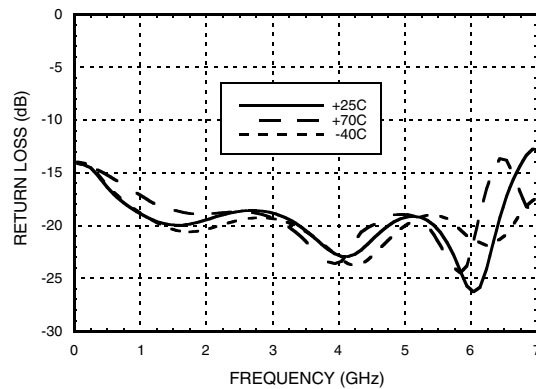

Reverse Isolation vs. Temperature

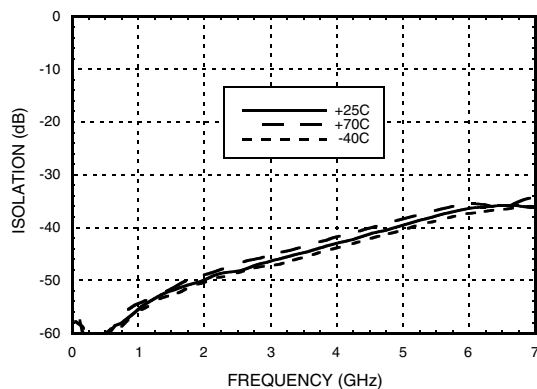

Noise Figure vs. Temperature

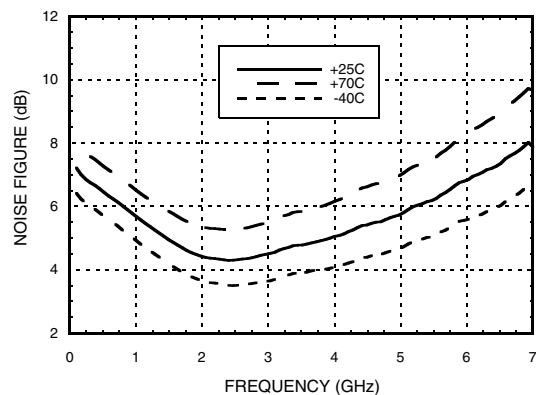

**SINGLE STAGE POWER AMPLIFIER
MODULE, 10 MHz - 6 GHz**



Output P1dB vs. Temperature

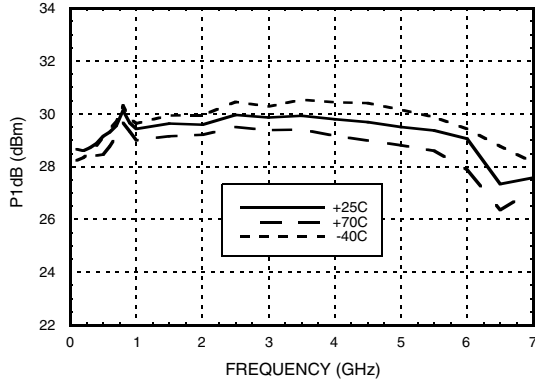

Output Psat vs. Temperature

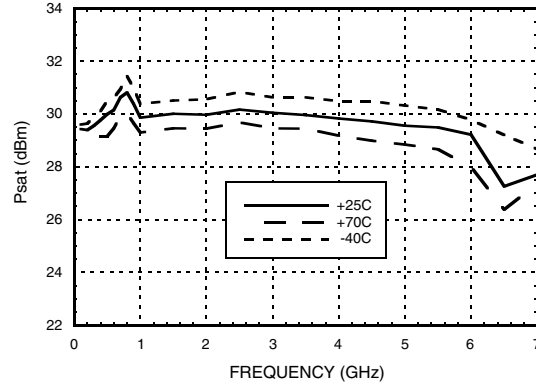

Output IP3 vs. Temperature

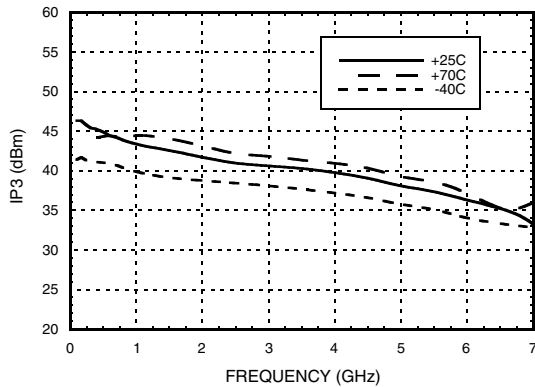

Power Compression @ 3 GHz

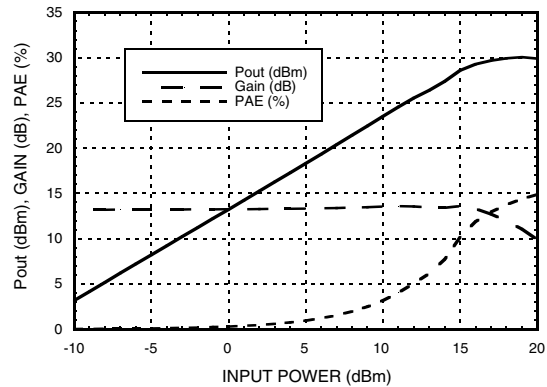

**Gain & Return Loss vs. Frequency
Log Scale**

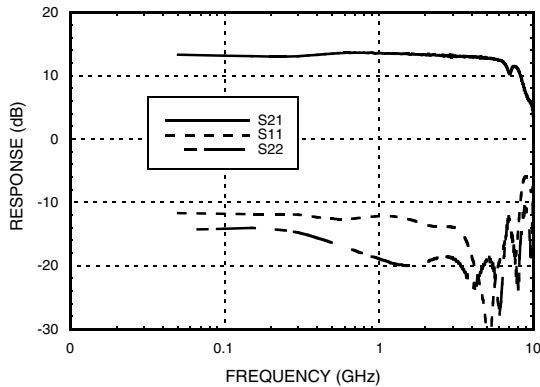

**Output IP3 vs. Temperature
Log Scale**

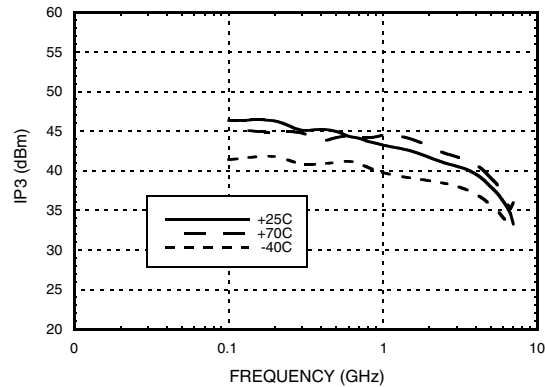



SINGLE STAGE POWER AMPLIFIER MODULE, 10 MHz - 6 GHz



Absolute Maximum Ratings

Positive Bias Supply Voltage (+Vdc)	+16V Max
Negative Bias Supply (-Vdc)	-16V Min.
RF Input Power (RFIN)	25 dBm
Thermal Resistance	9.46 °C/W
Storage Temperature	-55 to +150 °C
Operating Temperature	-40 to +70 °C

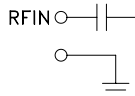
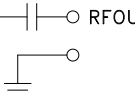

ELECTROSTATIC SENSITIVE DEVICE
OBSERVE HANDLING PRECAUTIONS

Pin Descriptions

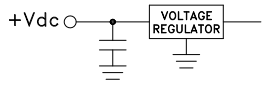
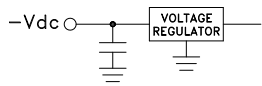
Pin Number	Function	Description	Interface Schematic
1	RFIN & RF Ground	RF input connector, SMA female, field replaceable. This pin is AC coupled and matched to 50 Ohms.	
2	RFOUT & RF Ground	RF output connector, SMA female. This pin is AC coupled and matched to 50 Ohms.	
3	GND	Power supply ground.	
4	+Vdc	Positive power supply voltage for the amplifier. (+14V to +16V)	
5	-Vdc	Negative power supply voltage for the amplifier. (-5V to -16V)	



Outline Drawing

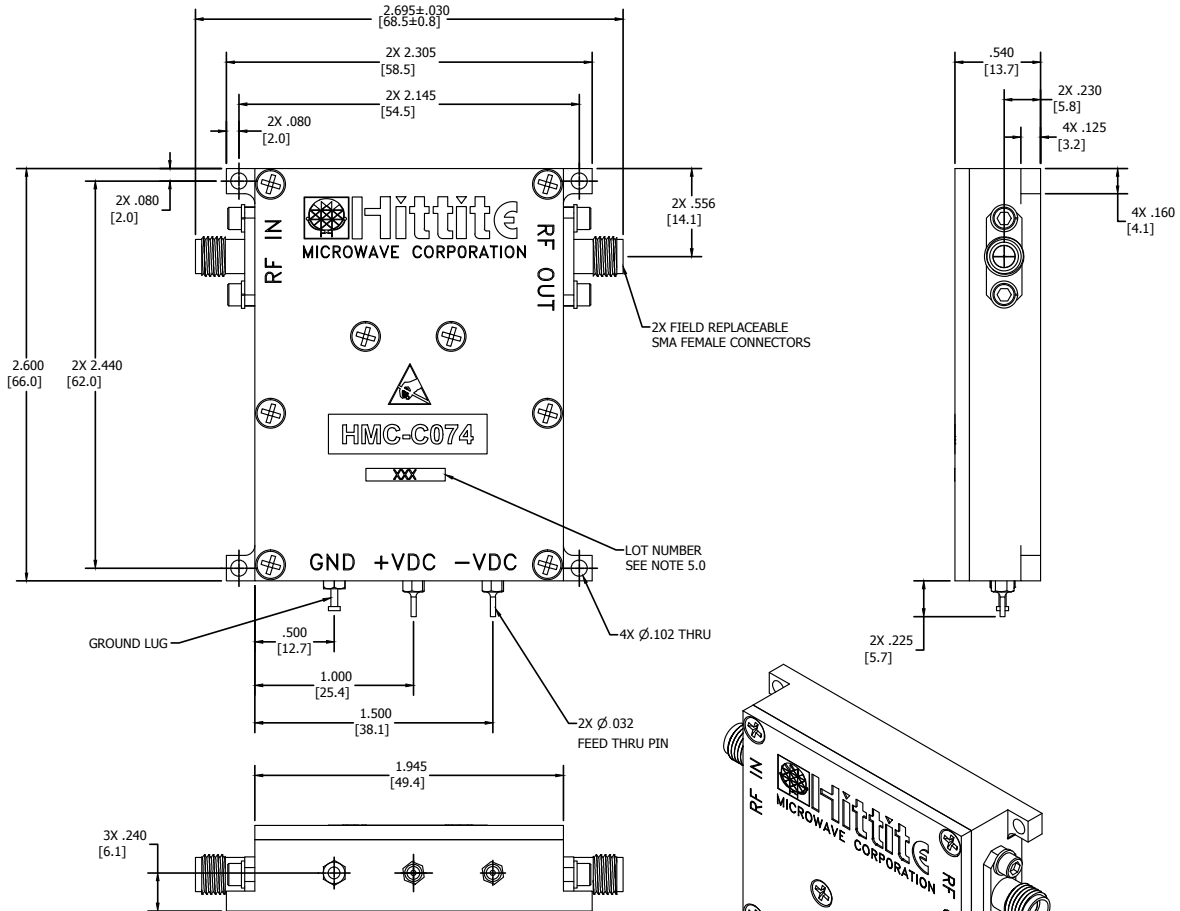

Package Information

Package Type	C-17
--------------	------

NOTES:

1. PACKAGE, COVER MATERIAL: ALUMINUM
2. FINISH: GOLD PLATE OVER NICKEL PLATE.
3. ALL DIMENSIONS ARE IN INCHES [MILLIMETERS].
4. TOLERANCES:
 - 4.1 .XX = ± 0.02
 - 4.2 .XXX = ± 0.010
5. MARK LOT NUMBER ON 0.080 X 0.250 LABEL WHERE SHOWN, WITH 0.030" MIN TEXT HEIGHT.

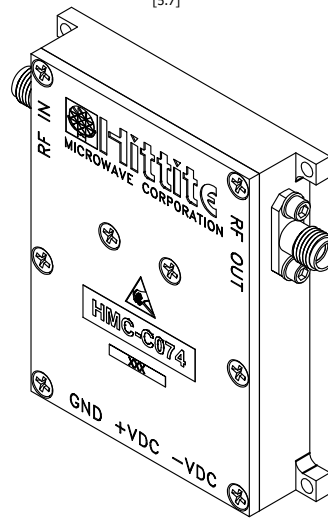



MICROWAVE CORPORATION v02.0711



HMC-C074

**SINGLE STAGE POWER AMPLIFIER
MODULE, 10 MHz - 6 GHz**

Notes:

1

AMPLIFIERS