

Analog Devices Welcomes Hittite Microwave Corporation

NO CONTENT ON THE ATTACHED DOCUMENT HAS CHANGED



THIS PAGE INTENTIONALLY LEFT BLANK



Typical Applications

The HMC-C059 Wideband LNA is ideal for:

- Telecom Infrastructure
- Microwave Radio & VSAT
- Military & Space
- Test Instrumentation
- Industrial Sensors

Functional Diagram

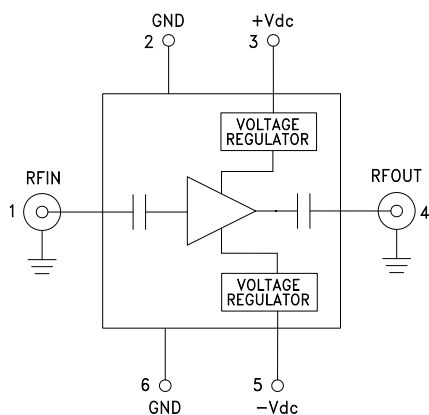

Features

- Noise Figure: 1.8 dB @ 8 GHz
- High Gain: 16 dB @ 8 GHz
- P1dB Output Power: +16 dBm @ 8 GHz
- Spurious-Free Operation
- Regulated Supply and Bias Sequencing
- Hermetically Sealed Module
- Field Replaceable SMA connectors
- 55 °C to +85 °C Operating Temperature

General Description

The HMC-C059 is a GaAs MMIC pHEMT Low Noise Distributed Amplifier in a miniature, hermetic module with replaceable SMA connectors which operates between 1 and 12 GHz. The amplifier provides 16 dB of gain, 1.8 dB noise figure, and up to +17 dBm of output power at 1 dB gain compression. The wideband amplifier I/Os are internally matched to 50 Ohms and are internally DC blocked. Integrated voltage regulators allow for flexible biasing of both the negative and positive supply pins, while internal bias sequencing circuitry assures robust operation.

Electrical Specifications, $T_A = +25^\circ C$, +Vdc = +6V, -Vdc = -5V

Parameter	Min.	Typ.	Max.	Min.	Typ.	Max.	Units
Frequency Range		1 - 8		8 - 12			GHz
Gain	14	16		12	14		dB
Gain Flatness		±1			±1.25		dB
Gain Variation Over Temperature		0.005			0.005		dB/ °C
Noise Figure		1.75	2.25		2.5	3	dB
Input Return Loss		-12			-7		dB
Output Return Loss		-17			-15		dB
Output Power for 1 dB Compression (P1dB)		17			14		dBm
Saturated Output Power (Psat)		19			17		dBm
Output Third Order Intercept (IP3)		31			29		dBm
Positive Supply Current (+IDC)		60	70		60	70	mA
Negative Supply Current (-IDC)		1.5			1.5		mA

For price, delivery, and to place orders, please contact Hittite Microwave Corporation:
 20 Alpha Road Chelmsford, MA 01824 Phone: 978-250-3343 Fax: 978-250-3373
 Order Online at www.hittite.com



Broadband Gain & Return Loss

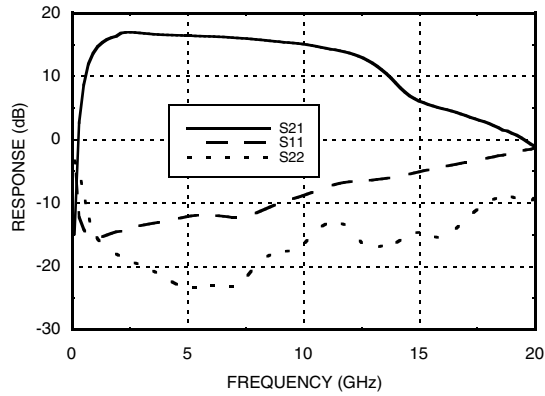

Gain vs. Temperature

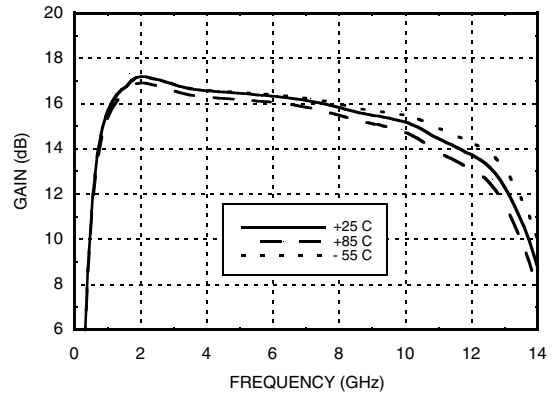

Input Return Loss vs. Temperature

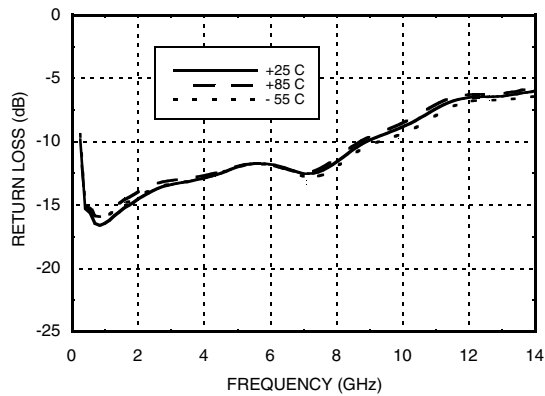

Output Return Loss vs. Temperature

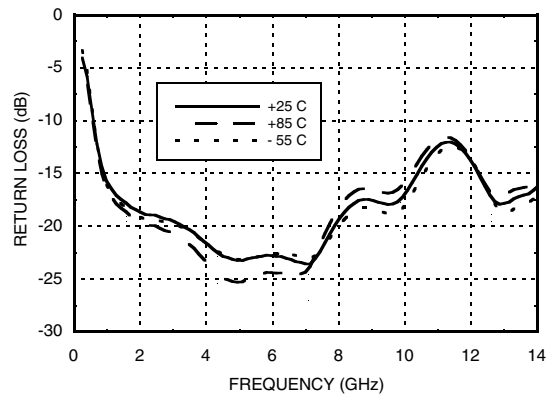

Reverse Isolation vs. Temperature

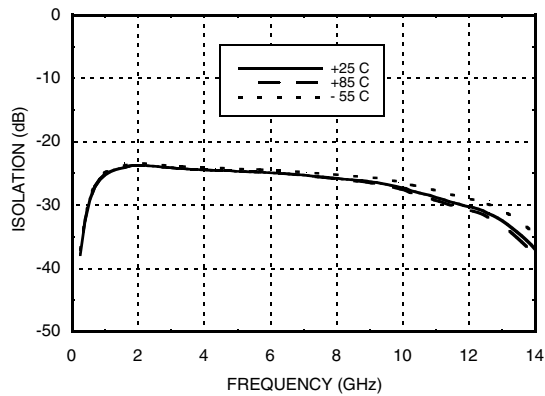

Noise Figure vs. Temperature

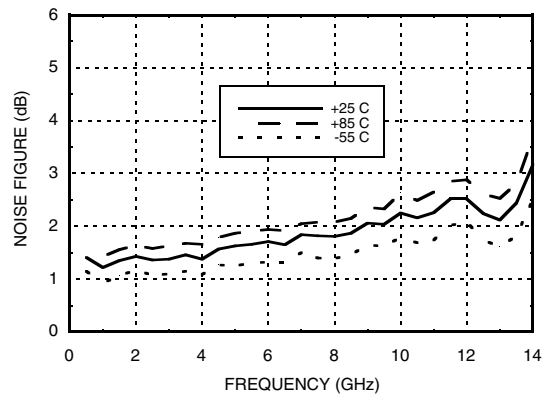



P1dB vs. Temperature

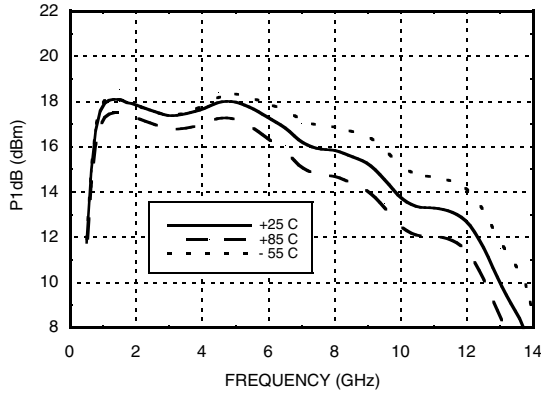

Psat vs. Temperature

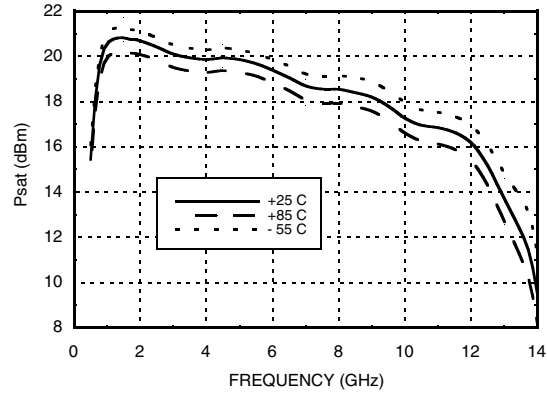

Output IP3 vs. Temperature

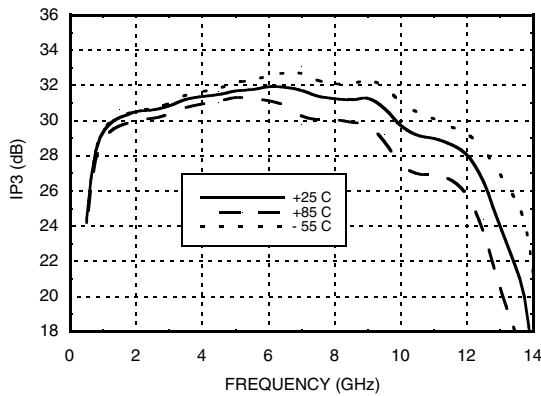

Absolute Maximum Ratings



Positive Bias Supply Voltage (+Vdc)	+16V
Negative Bias Supply (-Vdc)	-12V
RF Input Power (RFIN)	+10 dBm
Storage Temperature	-65 to +150 °C
Operating Temperature	-55 to +85 °C



**ELECTROSTATIC SENSITIVE DEVICE
OBSERVE HANDLING PRECAUTIONS**

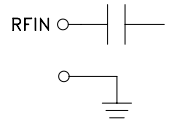

Pin Descriptions

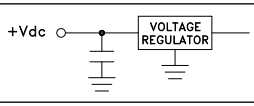
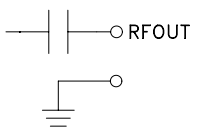
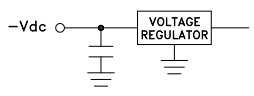
Pin Number	Function	Description	Interface Schematic
1	RFIN & RF Ground	RF input connector, SMA female, field replaceable. This pin is AC coupled and matched to 50 Ohms.	
2, 6	GND	Power supply ground.	
3	+Vdc	Positive power supply voltage for the amplifier.	
4	RFOUT & RF Ground	RF output connector, SMA female. This pin is AC coupled and matched to 50 Ohms.	
5	-Vdc	Negative power supply voltage for the amplifier	



Outline Drawing

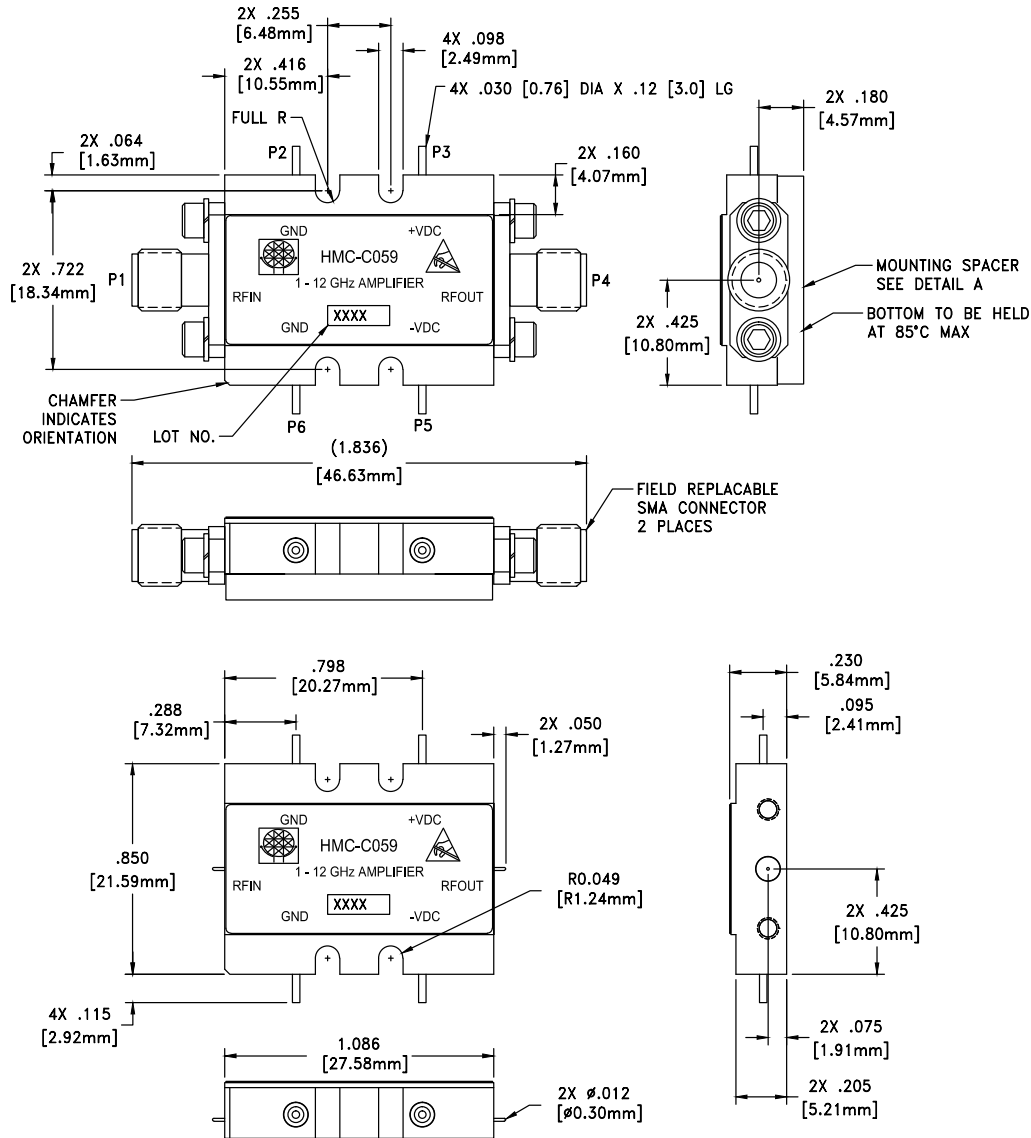

VIEW SHOWN WITH CONNECTORS AND MOUNTING SPACER REMOVED

Package Information

Package Type	C-10
Package Weight ^[1]	18.7 gms ^[2]
Spacer Weight	3.3 gms ^[2]

[1] Includes the connectors

[2] ±1 gms Tolerance

NOTES:

1. PACKAGE, LEADS, COVER MATERIAL: KOVAR™
2. FINISH: GOLD PLATE OVER NICKEL PLATE
3. ALL DIMENSIONS ARE IN INCHES [MILLIMETERS]
4. TOLERANCES:
 - 4.1 .XX = ±0.02
 - 4.2 .XXX = ±0.010
5. FIELD REPLACEABLE 2.92mm CONNECTORS TENSOLITE 231CCSF OR EQUIVALENT



Notes: