

SF2124E

**2441.8 MHz
SAW Filter**

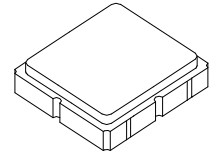

SM3030-6

- **Designed for RF Front-end Applications**
- **Low Insertion Loss**
- **3.0 x 3.0 x 1.3 mm Surface-mount Case**
- **No Matching Circuit Required**
- **For Automotive, complies with AEC-Q200 Qualification Testing**

Absolute Maximum Ratings

Rating	Value	Units
Input Power Level	+20	dBm
DC Voltage on any Non-ground Terminal	0	Volts
Operating Temperature Range	-40 to +100	°C
Storage Temperature Range in Tape and Reel	-40 to +85	°C
Suitable for Lead-free Soldering - Maximum Soldering Profile	260°C for 30 s	

Electrical Characteristics

Characteristic	Sym	Notes	Min	Typ	Max	Units
Center Frequency	f_c	1	2441.8			MHz
Insertion Loss, 2400.0 to 2483.5 MHz	IL	at 100°C		2.1	4.0	dB
		at 85°C		2.1	3.2	
Amplitude Ripple, 2400.0 to 2483.5 MHz				0.9	3.0	dB _{P-P}
Attenuation, referenced to 0 dB						dB
DC to 1700 MHz			20.0	29.0		
1700 to 2200 MHz			25.0	30.0		
2700 to 3100 MHz			30.0	40.0		
3100 to 4000 MHz			20.0	29.0		
4000 to 5000 MHz			10.0	20.0		
VSWR, 2400 to 2483.5 MHz				1.7	2.6	
Source Impedance	Z_s			50		Ω
Load Impedance	Z_L			50		Ω
Single-Ended Input / Output Impedance Match	No matching network required for operation at 50 ohms					
Case Style	SM3030-6 3 x 3 mm Nominal Footprint					
Lid Symbolization, Y=year, WW=week, S=shift	646 YWWS					

Electrical Connections

Pin #	Description	Pin #	Description
1	Ground	4	Ground
2	Input	5	Output
3	Ground	6	Ground

 **CAUTION: Electrostatic Sensitive Device. Observe precautions for handling.**
Notes:

1. Unless noted otherwise, all specifications apply over the operating temperature range with filter soldered to the specified demonstration board with impedance matching to 50 Ω and measured with 50 Ω network analyzer.
2. Unless noted otherwise, all frequency specifications are referenced to the nominal center frequency, f_c .
3. Rejection is measured as attenuation below the minimum IL point in the passband. Rejection in final user application is dependent on PCB layout and external impedance matching design. See Application Note No. 42 for details.
4. "LRIP" or "L" after the part number indicates "low rate initial production" and "ENG" or "E" indicates "engineering parts."
5. The design, manufacturing process, and specifications of this filter are subject to change.
6. Either Port 1 or Port 2 may be used for either input or output in the design. However, impedances and impedance matching may vary between Port 1 and Port 2, so that the filter must always be installed in one direction per the circuit design.
7. US and international patents may apply.
8. Murata, stylized Murata logo, and Murata N.A., Inc. are registered trademarks of Murata Manufacturing Co., Ltd.

Transfer function :

(1) S21 response (span : 300 MHz)

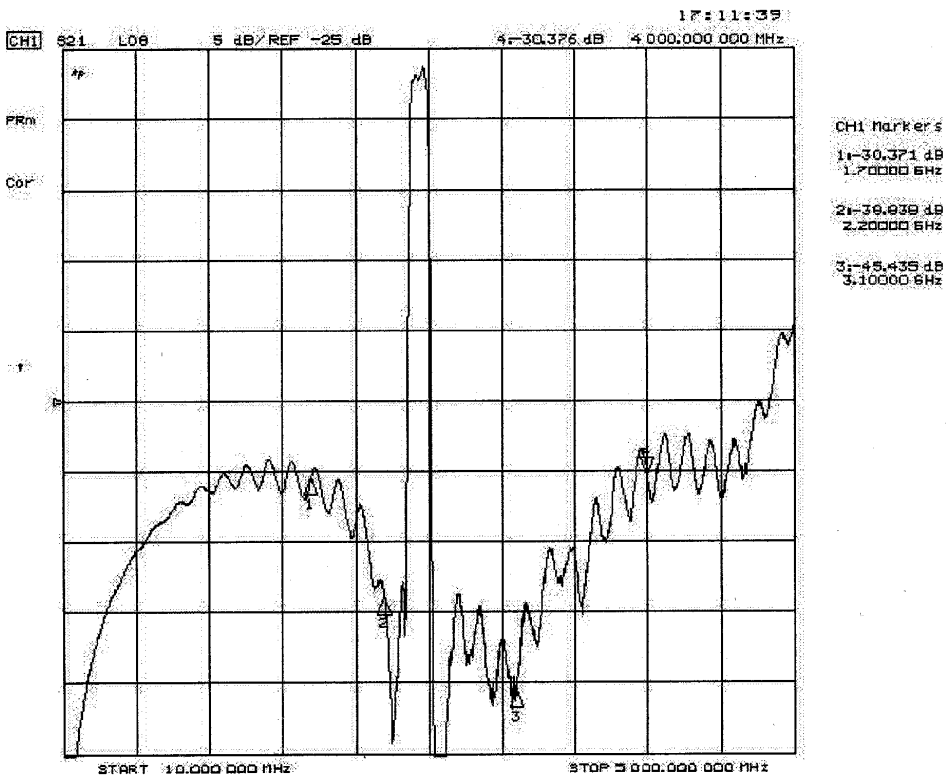
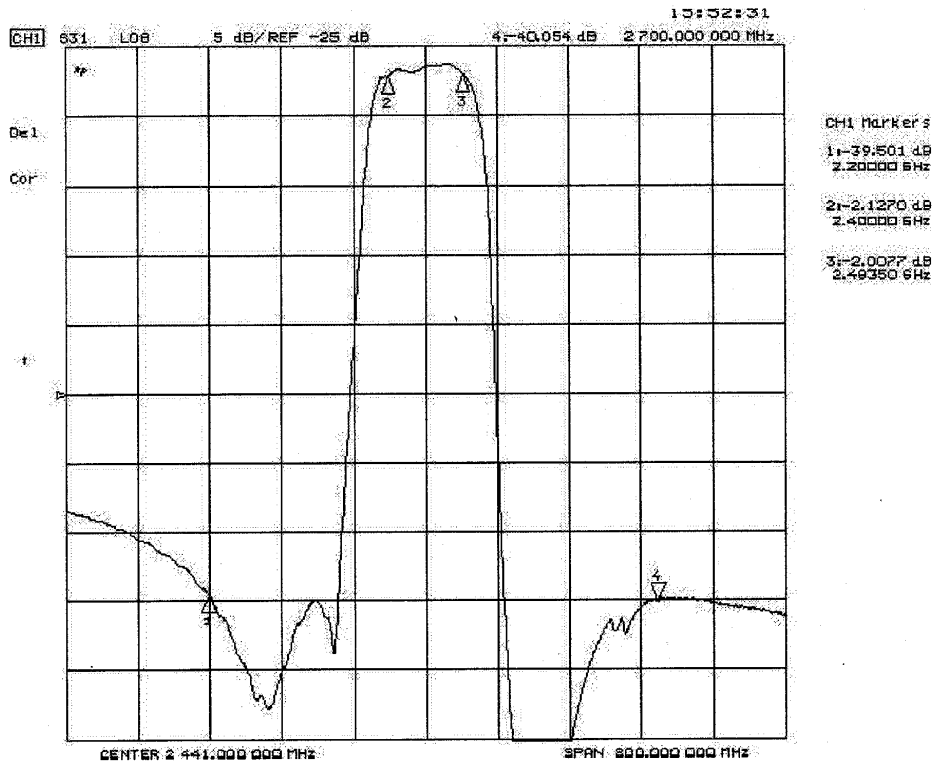

Reflection Functions:

S11

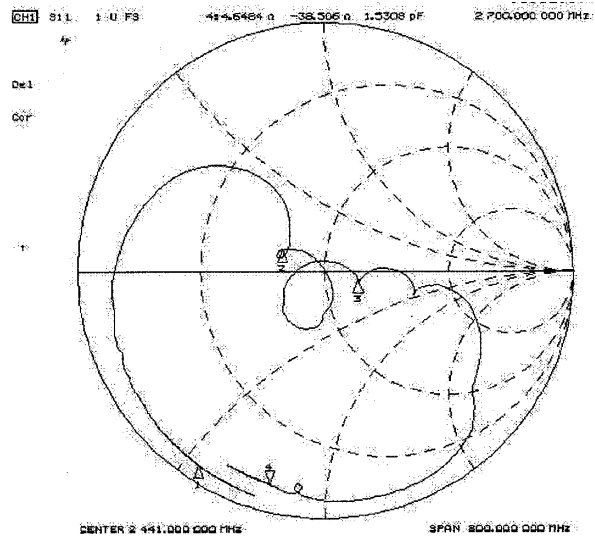
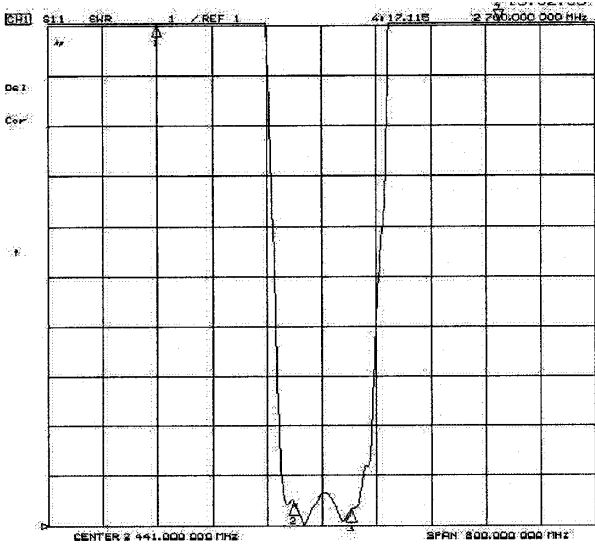

S22

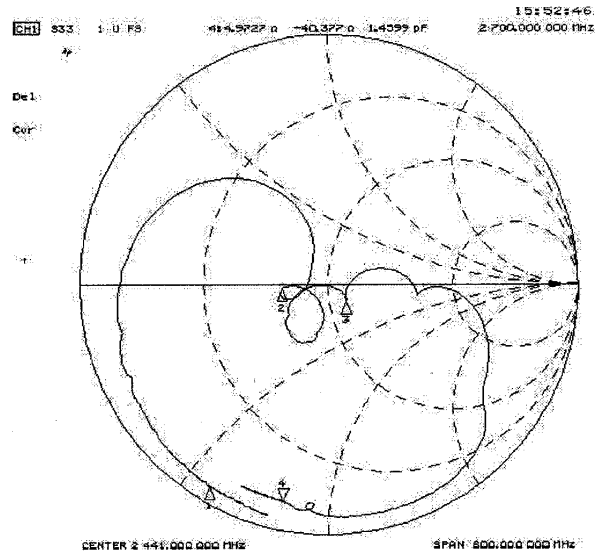
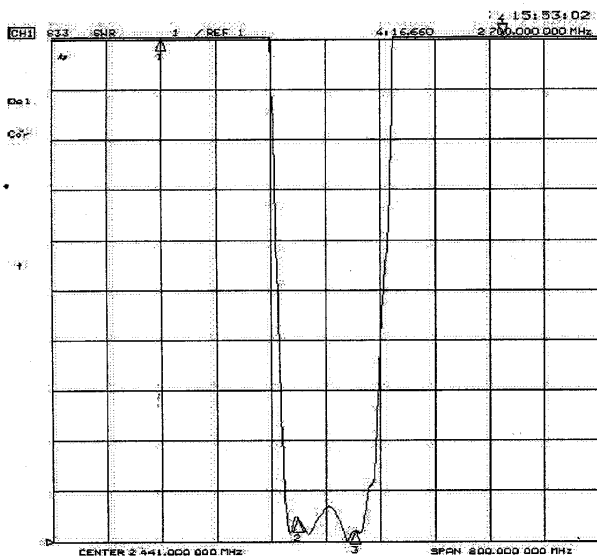

SM3030-6 Case

6-Terminal Ceramic Surface-Mount Case 3.0 X 3.0 mm Nominal Footprint

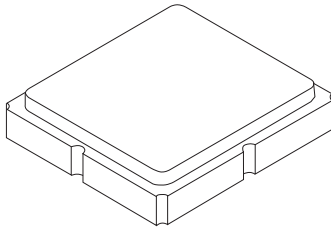

PCB Footprint Top View

Case and PCB Footprint Dimensions

Dimension	mm			Inches		
	Min	Nom	Max	Min	Nom	Max
A	2.87	3.00	3.13	0.113	0.118	0.123
B	2.87	3.00	3.13	0.113	0.118	0.123
C	1.12	1.25	1.38	0.044	0.049	0.054
D	0.77	0.90	1.03	0.030	0.035	0.040
E	2.67	2.80	2.93	0.105	0.110	0.115
F	1.47	1.60	1.73	0.058	0.063	0.068
G	0.72	0.85	0.98	0.028	0.033	0.038
H	1.37	1.50	1.63	0.054	0.059	0.064
I	0.47	0.60	0.73	0.019	0.024	0.029
J	1.17	1.30	1.43	0.046	0.051	0.056
K		3.20			0.126	
L		1.70			0.067	
M		1.05			0.041	
N		0.81			0.032	
O		0.38			0.015	

Case Materials

Materials	
Solder Pad Plating	0.3 to 1.0 μ m Gold over 1.27 to 8.89 μ m Nickel
Lid Plating	2.0 to 3.0 μ m Nickel
Body	Al ₂ O ₃ Ceramic
Pb Free	

TOP VIEW

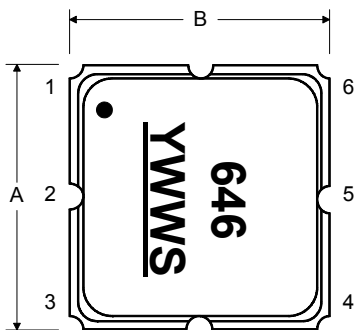

BOTTOM VIEW

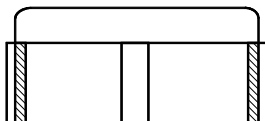
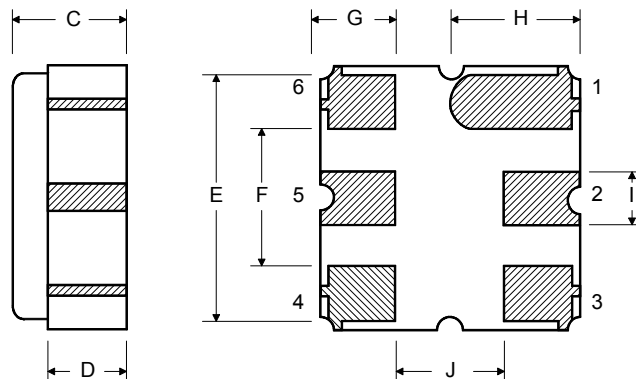

Tape and Reel Specifications

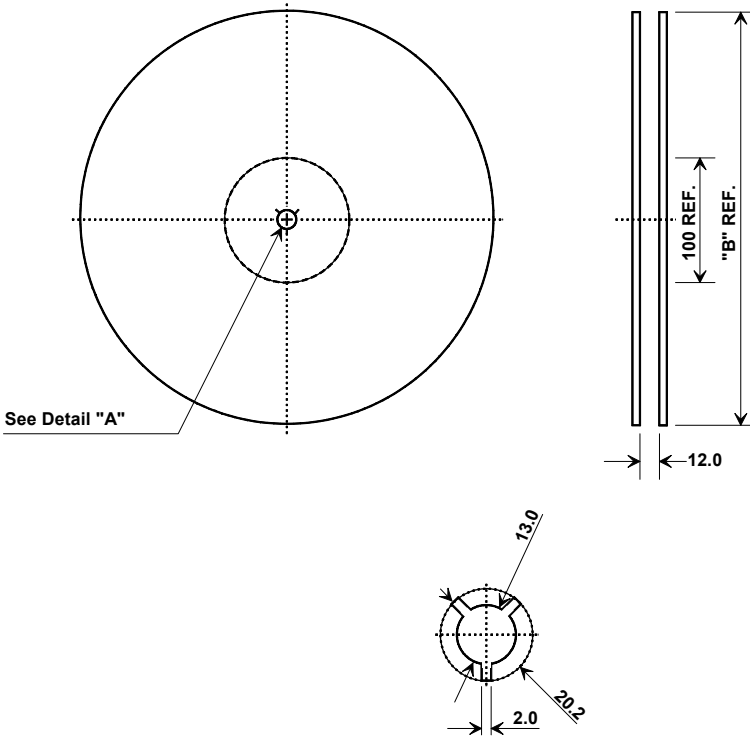

"B"		Quantity Per Reel
Inches	millimeters	
7	178	500
13	330	2000

COMPONENT ORIENTATION

