

Analog Devices Welcomes Hittite Microwave Corporation

NO CONTENT ON THE ATTACHED DOCUMENT HAS CHANGED



THIS PAGE INTENTIONALLY LEFT BLANK



HIGH ISOLATION SPDT Non-Reflective Switch, DC - 4 GHz

Typical Applications

The HMC349ALP4CE is ideal for:

- Basestation Infrastructure
- MMDS & 3.5 GHz WLL
- CATV/CMTS
- Test Instrumentation

Functional Diagram

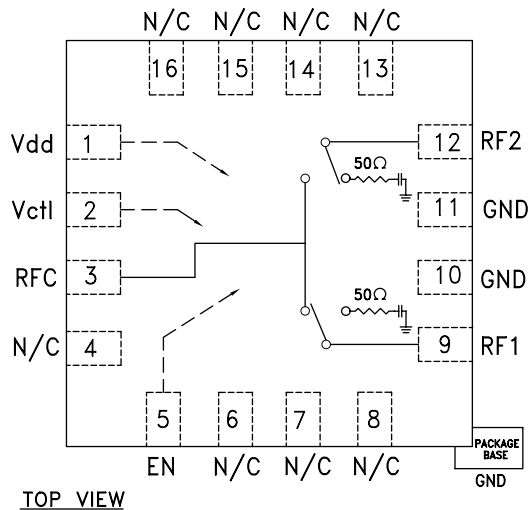

TOP VIEW

Features

- High Isolation: 67 dB @ 1 GHz
62 dB @ 2 GHz
- Single Positive Control: 0/+5V
- +53 dBm Input IP3
- Non-Reflective Design
- All Off State
- 16 mm² Leadless QFN SMT Package

General Description

The HMC349ALP4CE is a high isolation non-reflective DC to 4 GHz GaAs MESFET SPDT switch in a low cost leadless surface mount package. The switch is ideal for cellular/PCS/3G basestation applications yielding 60 to 65 dB isolation, low 0.9 dB insertion loss and +53 dBm input IP3. Power handling is excellent up through the 3.5 GHz WLL band with the switch offering a P1dB compression point of +31 dBm. On-chip circuitry allows a single positive voltage control of 0/+5 Volts at very low DC currents. An enable input (EN) set to logic high will put the switch in an "all off" state.

Electrical Specifications, $T_A = +25^\circ C$, $V_{ctl} = 0/+5 V_{dc}$, $V_{dd} = +5 V_{dc}$, 50 Ohm System

Parameter	Frequency	Min.	Typ.	Max.	Units
Insertion Loss	DC - 1.0 GHz		0.9	1.2	dB
	DC - 2.0 GHz		1.0	1.3	dB
	DC - 3.0 GHz		1.2	1.5	dB
	DC - 4.0 GHz		1.4	1.7	dB
Isolation (RFC to RF1/RF2)	DC - 1.0 GHz	60	67		dB
	DC - 4.0 GHz	55	62		dB
Return Loss (On State)	DC - 2.0 GHz		22		dB
	DC - 3.0 GHz		20		dB
	DC - 4.0 GHz		17		dB
Return Loss (Off State)	0.5 - 4.0 GHz		20		dB
Input Power for 1 dB Compression	0.25 - 4.0 GHz	30	34		dBm
Input Third Order Intercept (Two-Tone Input Power = +10 dBm Each Tone)	0.25 - 4.0 GHz		53		dBm
Switching Speed	DC - 4.0 GHz		60		ns
		tRISE, tFALL (10/90% RF) tON, tOFF (50% CTL to 10/90% RF)	150		ns



**HIGH ISOLATION SPDT
Non-Reflective Switch, DC - 4 GHz**

Insertion Loss

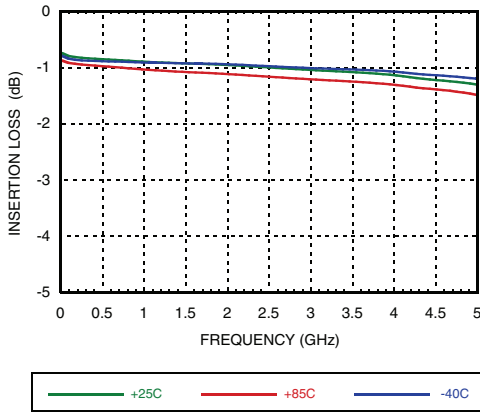

Return Loss

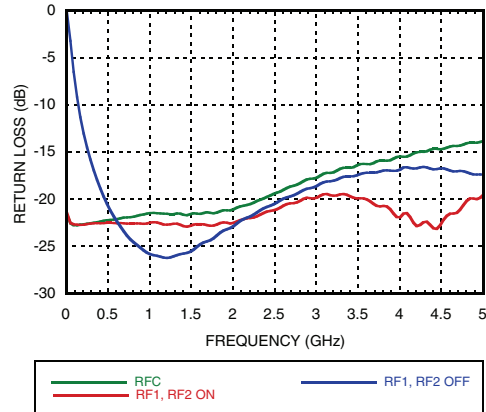

Note: RFC is reflective in "all off" state.

**Isolation Between
Ports RFC and RF1 / RF2**

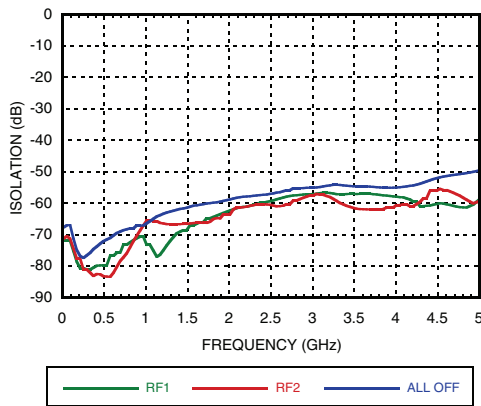

Isolation Between Ports RF1 and RF2

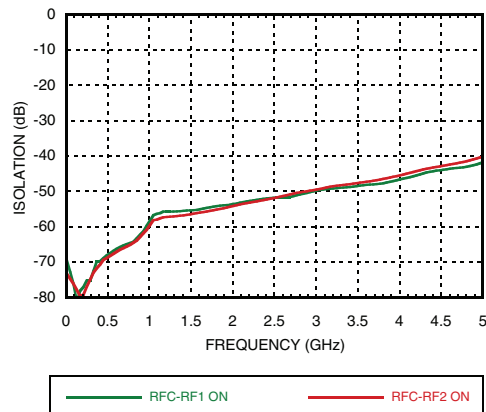

0.1 and 1 dB Input Compression Point

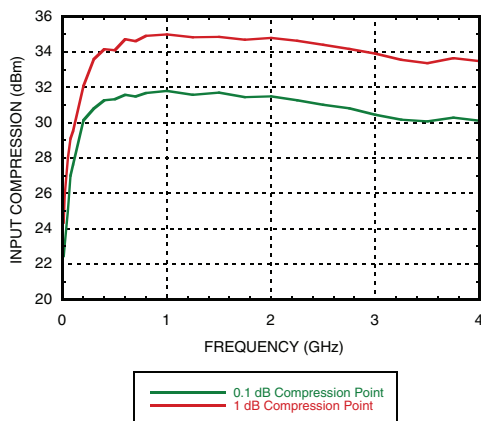

Input Third Order Intercept Point

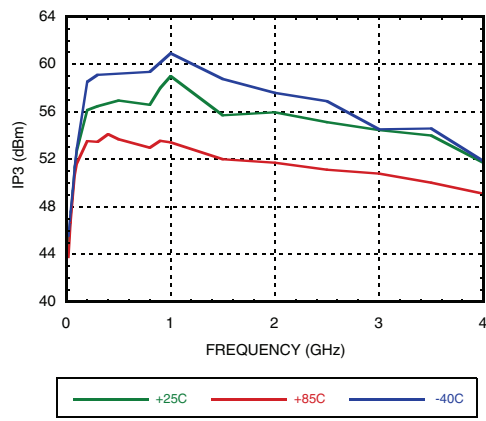

**HIGH ISOLATION SPDT
Non-Reflective Switch, DC - 4 GHz**
Absolute Maximum Ratings

RF Input Power (Vdd/Vctl = +5V) (0.25 - 4 GHz)	
Through Path	+33.6 dBm (T = 85 °C) +28 dBm (T = 125 °C)
Termination Path	+26.5 dBm (T = 85 °C) +21 dBm (T = 125 °C)
Supply Voltage Range (Vdd)	+7 Vdc
Control Voltage Range (Vctl)	-1V to Vdd +1V
Hot Switch Power Level (Vdd = +5V)	+30 dBm (T = 85 °C) +25 dBm (T = 125 °C)
Channel Temperature	150 °C
Continuous P _{diss} (T = 85 °C) (derate 14.9 mW/°C for through path, 6.9 mW/°C for termination path above 85 °C)	
Through Path	0.969 W
Termination Path	0.451 W
Thermal Resistance	
Through Path	67.1 °C/W
Termination Path	144.2 °C/W
Storage Temperature	-65 to +150 °C
Operating Temperature	-40 to +125 °C
ESD Sensitivity (HBM)	
All pins Vdd to ground	Class 1A 350V

Note: DC blocking capacitors are required at ports RFC, RF1 and RF2. Their value will determine the lowest transmission frequency.

Bias Voltage & Current

Vdd Range = +5.0 Vdc ± 10%		
Vdd (Vdc)	I _{dd} (Typ.) (mA)	I _{dd} (Max.) (mA)
+5.0	1.0	3.5

TTL/CMOS Control Voltages

State	Bias Condition
Low	0 to +0.8 Vdc @ <1 μA Typical
High	+2.0 to +5.0 Vdc @ 35 μA Typical

Truth Table

Control Input		Signal Path State	
Vctl	EN	RFC - RF1	RFC - RF2
Low	Low	OFF	ON
High	Low	ON	OFF
Low	High	OFF	OFF
High	High	OFF	OFF



**ELECTROSTATIC SENSITIVE DEVICE
OBSERVE HANDLING PRECAUTIONS**

Outline Drawing

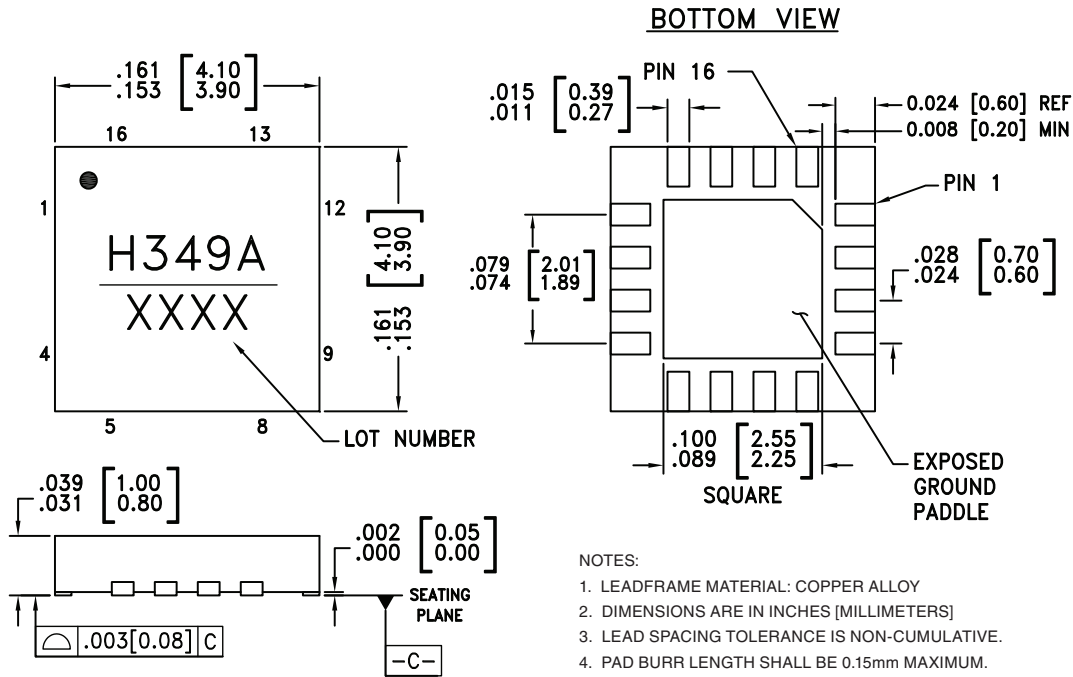

Package Information

Part Number	Package Body Material	Lead Finish	MSL Rating	Package Marking ^[1]
HMC349ALP4CE	RoHS-compliant Low Stress Injection Molded Plastic	100% matte Sn	MSL1 ^[2]	H349A XXXX



[1] 4-Digit lot number XXXX

[2] Max peak reflow temperature of 260 °C

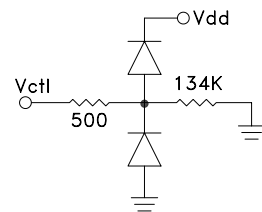
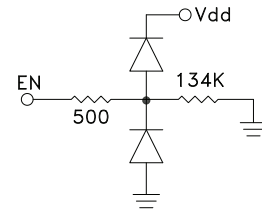

HIGH ISOLATION SPDT Non-Reflective Switch, DC - 4 GHz

Pin Descriptions

Pin Number	Function	Description	Interface Schematic
1	Vdd	Supply Voltage.	
2	Vctl	Control input. See truth and control voltage tables.	
3, 9, 12	RFC, RF1, RF2	These pins are DC coupled and matched to 50 Ohms. Blocking capacitors are required.	
4, 6, 7, 8, 13, 14, 15, 16	N/C	No connection. These pins may be connected to RF ground. Performance will not be affected.	
5	EN	Enable. See truth and control voltage tables.	
10, 11	GND	Package bottom must also be connected to PCB RF ground.	

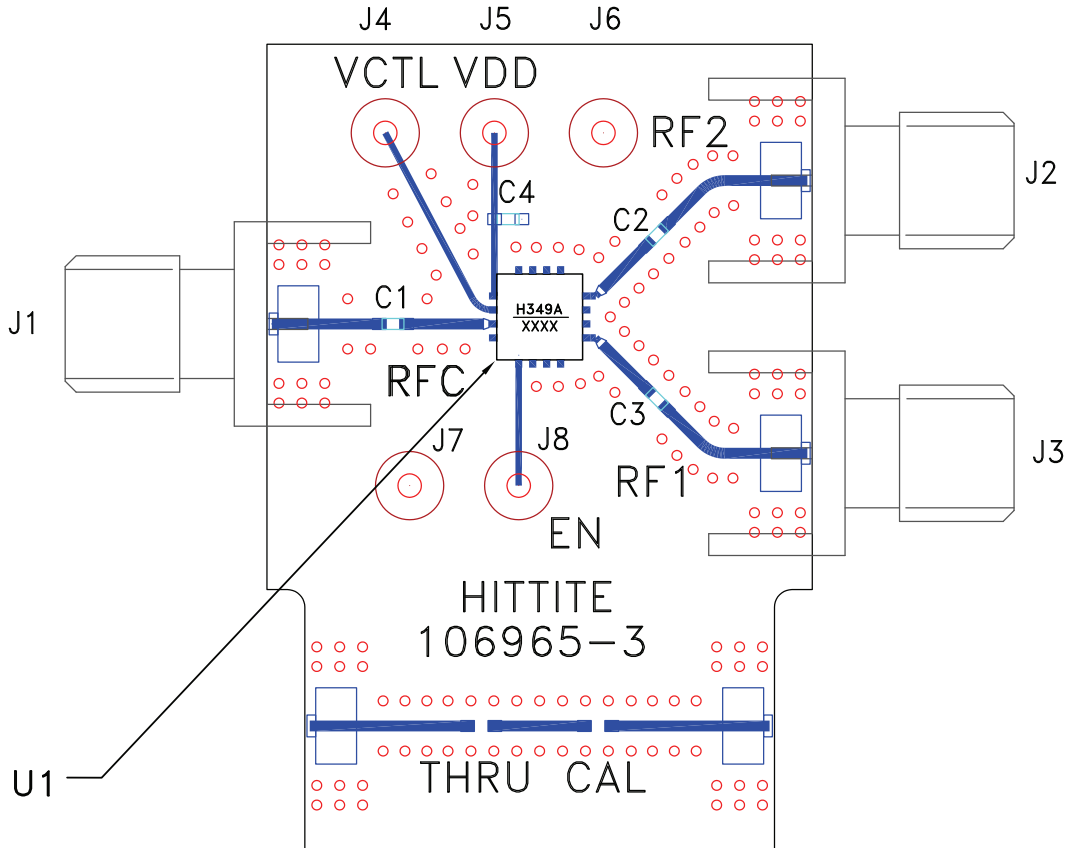
Evaluation PCB

**List of Materials for Evaluation PCB
106975 - HMC349ALP4C [1]**

Item	Description
J1 - J3	PC Mount SMA RF Connector
J4 - J8	DC Pin
C1 - C4	100 pF Capacitor, 0402 Pkg.
U1	HMC349ALP4CE SPDT Switch
PCB [2]	106965 Evaluation PCB

[1] Reference this number when ordering complete evaluation PCB

[2] Circuit Board Material: Rogers 4350

The circuit board used in the application should be generated with proper RF circuit design techniques. Signal lines at the RF port should have 50 Ohm impedance and the package ground leads and backside ground slug should be connected directly to the ground plane similar to that shown above. The evaluation circuit board shown above is available from Hittite Microwave Corporation upon request.