

Coaxial

Voltage Controlled Oscillator

ZX95-800C+

Ultra Low Noise 798 to 803 MHz

Features

- ultra low phase noise
- linear tuning characteristics
- low pulling
- very low pushing
- protected by US patent 6,790,049



CASE STYLE: GB956

Applications

- r & d
- lab
- instrumentation
- wireless communication
- test equipment

| Connectors | Model | Price | Qty. |
|------------|--------------|-------------|-------|
| SMA | ZX95-800C-S+ | \$51.95 ea. | (1-9) |

+RoHS Compliant
The +Suffix identifies RoHS Compliance. See our web site for RoHS Compliance methodologies and qualifications

Electrical Specifications

| MODEL NO. | FREQ. (MHz) | | POWER OUTPUT (dBm) | PHASE NOISE dBc/Hz SSB at offset frequencies, kHz | | | | TUNING | | | | | NON HARMONIC SPURIOUS (dBc) | HARMONICS (dBc) | | PULLING pk-pk @ 12 dB (MHz) | PUSHING (MHz/V) | DC OPERATING POWER | |
|------------|-------------|------|--------------------|---|------|------|------|--------|-------------------|---------------------|---------------|---------------------------------|-----------------------------|-----------------|------|-----------------------------|-----------------|--------------------|------|
| | Min. | Max. | | Typ. | 1 | 10 | 100 | 1000 | VOLTAGE RANGE (V) | SENSITIVITY (MHz/V) | PORT CAP (pF) | 3 dB MODULATION BANDWIDTH (MHz) | | Typ. | Typ. | | | Max. | Typ. |
| ZX95-800C+ | 798 | 803 | +5.3 | -97 | -124 | -145 | -165 | 0.5 | 4.5 | 3.5 | 40 | 60 | -90 | -28 | -19 | 0.2 | 0.02 | 5 | 35 |

Maximum Ratings

| | |
|--------------------------------------|----------------|
| Operating Temperature | -55°C to 85°C |
| Storage Temperature | -55°C to 100°C |
| Absolute Max. Supply Voltage (Vcc) | 7V |
| Absolute Max. Tuning Voltage (Vtune) | 7V |
| All specifications | 50 ohm system |

Permanent damage may occur if any of these limits are exceeded.

Outline Drawing

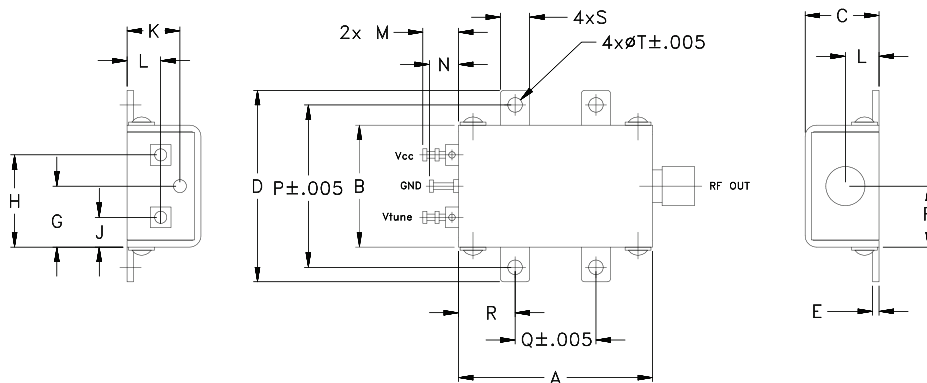

Outline Dimensions (inch/mm)

| A | B | C | D | E | F | G | H | J | K | L | M | N | P | Q | R | S | T | wt. |
|-------|-------|-------|-------|------|------|------|-------|------|------|------|------|------|-------|-------|------|------|------|-------|
| 1.20 | .75 | .46 | 1.18 | .04 | .38 | .38 | .57 | .18 | .33 | .21 | .22 | .18 | 1.00 | .50 | .35 | .18 | .106 | grams |
| 30.48 | 19.05 | 11.68 | 29.97 | 1.02 | 9.65 | 9.65 | 14.48 | 4.57 | 8.38 | 5.33 | 5.59 | 4.57 | 25.40 | 12.70 | 8.89 | 4.57 | 2.69 | 35.0 |



For detailed performance specs & shopping online see web site

P.O. Box 350166, Brooklyn, New York 11235-0003 (718) 934-4500 Fax (718) 332-4661 The Design Engineers Search Engine & Provides ACTUAL Data Instantly at minicircuits.com

Notes: 1. Performance and quality attributes and conditions not expressly stated in this specification sheet are intended to be excluded and do not form a part of this specification sheet. 2. Electrical specifications and performance data contained herein are based on Mini-Circuit's applicable established test performance criteria and measurement instructions. 3. The parts covered by this specification sheet are subject to Mini-Circuits standard limited warranty and terms and conditions (collectively, "Standard Terms"); Purchasers of this part are entitled to the rights and benefits contained therein. For a full statement of the Standard Terms and the exclusive rights and remedies thereunder, please visit Mini-Circuits' website at www.minicircuits.com/MCLStore/terms.jsp.

REV. OR
M119372
EDR-9004F2
ZX95-800C+
RAV
120830
Page 1 of 2

Performance Data & Curves*

ZX95-800C+

| V TUNE | TUNE SENS (MHz/V) | FREQUENCY (MHz) | | | POWER OUTPUT (dBm) | | | Icc (mA) | HARMONICS (dBc) | | | FREQ. PUSH (MHz/V) | FREQ. PULL (MHz) | PHASE NOISE (dBc/Hz) at offsets | | | | FREQ OFFSET (KHz) | PHASE NOISE at 801 MHz (dBc/Hz) |
|--------|-------------------|-----------------|-------|-------|--------------------|-------|-------|----------|-----------------|-------|-------|--------------------|------------------|---------------------------------|--------|--------|--------|-------------------|---------------------------------|
| | | -55°C | +25°C | +85°C | -55°C | +25°C | +85°C | | F2 | F3 | F4 | | | 1kHz | 10kHz | 100kHz | 1MHz | | |
| 0.00 | 4.58 | 793.7 | 792.2 | 790.9 | 5.60 | 5.78 | 5.73 | 25.66 | -26.4 | -38.8 | -36.1 | 0.13 | 0.21 | -96.6 | -124.9 | -145.4 | -164.8 | 1.0 | -97.06 |
| 0.25 | 4.03 | 794.8 | 793.3 | 792.1 | 5.55 | 5.72 | 5.68 | 25.64 | -26.6 | -38.5 | -36.2 | 0.04 | 0.20 | -97.9 | -125.7 | -144.6 | -165.1 | 2.0 | -106.37 |
| 0.50 | 3.75 | 795.7 | 794.3 | 793.2 | 5.49 | 5.67 | 5.63 | 25.61 | -26.7 | -38.4 | -36.4 | 0.01 | 0.20 | -98.4 | -124.6 | -144.8 | -165.5 | 3.5 | -112.90 |
| 0.75 | 3.60 | 796.7 | 795.3 | 794.1 | 5.44 | 5.63 | 5.59 | 25.58 | -26.9 | -38.3 | -36.5 | 0.01 | 0.20 | -96.9 | -124.4 | -146.3 | -165.1 | 6.0 | -118.96 |
| 1.00 | 3.52 | 797.5 | 796.2 | 795.0 | 5.39 | 5.58 | 5.55 | 25.56 | -27.1 | -38.2 | -36.6 | 0.02 | 0.20 | -97.0 | -124.7 | -144.8 | -165.6 | 8.5 | -122.69 |
| 1.25 | 3.48 | 798.4 | 797.0 | 795.9 | 5.34 | 5.53 | 5.51 | 25.53 | -27.2 | -38.1 | -36.8 | 0.03 | 0.20 | -97.5 | -124.0 | -144.8 | -165.1 | 10.0 | -124.39 |
| 1.50 | 3.46 | 799.3 | 797.9 | 796.8 | 5.29 | 5.48 | 5.47 | 25.50 | -27.4 | -38.0 | -36.8 | 0.03 | 0.20 | -97.4 | -124.3 | -145.6 | -164.1 | 20.8 | -131.33 |
| 1.75 | 3.47 | 800.1 | 798.8 | 797.7 | 5.24 | 5.44 | 5.43 | 25.48 | -27.6 | -37.9 | -36.9 | 0.03 | 0.20 | -96.5 | -124.4 | -145.7 | -165.4 | 35.5 | -135.19 |
| 2.00 | 3.48 | 801.0 | 799.6 | 798.5 | 5.19 | 5.39 | 5.39 | 25.46 | -27.8 | -37.8 | -37.0 | 0.03 | 0.20 | -97.3 | -124.8 | -144.7 | -164.2 | 60.7 | -139.18 |
| 2.25 | 3.50 | 801.9 | 800.5 | 799.4 | 5.13 | 5.34 | 5.35 | 25.43 | -28.0 | -37.6 | -37.2 | 0.02 | 0.20 | -97.7 | -124.7 | -144.9 | -164.3 | 86.7 | -142.77 |
| 2.50 | 3.51 | 802.7 | 801.4 | 800.3 | 5.08 | 5.29 | 5.30 | 25.41 | -28.2 | -37.5 | -37.4 | 0.01 | 0.21 | -97.6 | -124.2 | -144.8 | -164.4 | 100.0 | -144.86 |
| 2.75 | 3.53 | 803.6 | 802.3 | 801.2 | 5.03 | 5.24 | 5.26 | 25.38 | -28.4 | -37.3 | -37.6 | 0.00 | 0.21 | -97.8 | -124.3 | -145.4 | -164.8 | 148.1 | -148.72 |
| 3.00 | 3.53 | 804.5 | 803.1 | 802.1 | 4.97 | 5.19 | 5.21 | 25.35 | -28.6 | -37.2 | -37.9 | 0.01 | 0.21 | -97.5 | -124.0 | -145.5 | -164.8 | 211.6 | -152.05 |
| 3.25 | 3.53 | 805.4 | 804.0 | 802.9 | 4.92 | 5.14 | 5.17 | 25.33 | -28.8 | -37.0 | -38.1 | 0.03 | 0.21 | -97.3 | -124.5 | -144.5 | -164.5 | 302.4 | -155.24 |
| 3.50 | 3.52 | 806.3 | 804.9 | 803.8 | 4.86 | 5.09 | 5.12 | 25.30 | -28.9 | -36.9 | -38.4 | 0.05 | 0.21 | -96.9 | -124.7 | -144.9 | -165.2 | 361.5 | -156.51 |
| 3.75 | 3.50 | 807.1 | 805.8 | 804.7 | 4.81 | 5.04 | 5.07 | 25.27 | -29.0 | -36.8 | -38.7 | 0.06 | 0.21 | -97.5 | -124.2 | -145.0 | -164.4 | 507.5 | -159.88 |
| 4.00 | 3.47 | 808.0 | 806.7 | 805.6 | 4.76 | 4.99 | 5.03 | 25.25 | -29.2 | -36.7 | -38.9 | 0.09 | 0.21 | -96.7 | -124.5 | -144.1 | -165.1 | 606.7 | -161.40 |
| 4.25 | 3.44 | 808.9 | 807.5 | 806.5 | 4.70 | 4.94 | 4.98 | 25.22 | -29.1 | -36.6 | -39.2 | 0.10 | 0.21 | -96.4 | -123.4 | -145.8 | -164.2 | 851.6 | -163.09 |
| 4.50 | 3.40 | 809.7 | 808.4 | 807.3 | 4.65 | 4.89 | 4.93 | 25.19 | -29.3 | -36.5 | -39.4 | 0.12 | 0.21 | -96.5 | -124.6 | -144.8 | -164.0 | 1000.0 | -163.97 |

*at 25°C unless mentioned otherwise

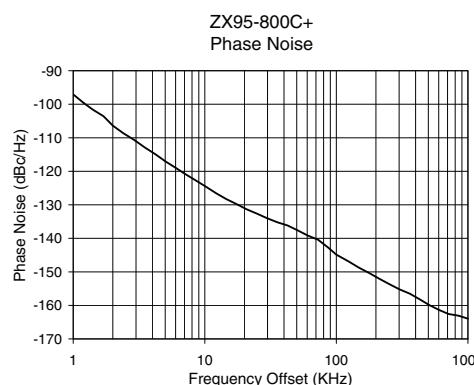
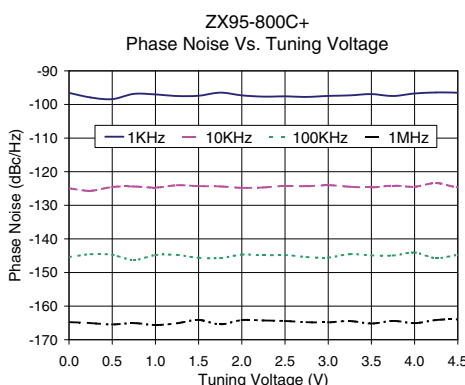
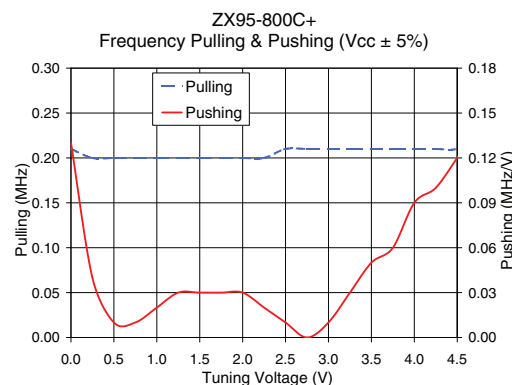
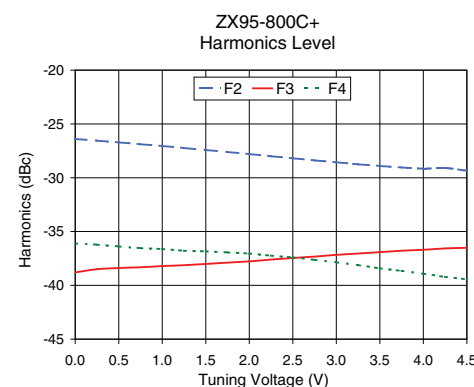
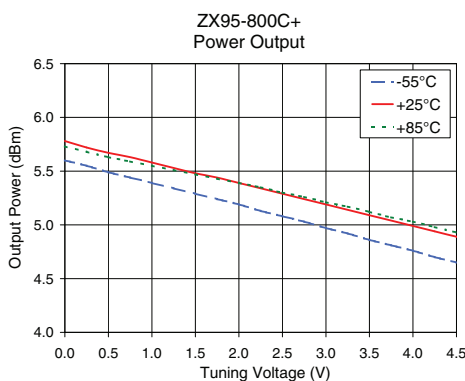
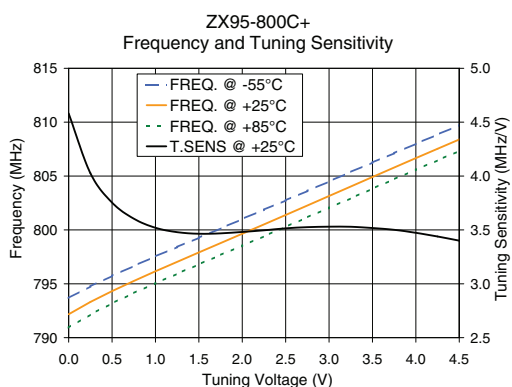

For detailed performance specs & shopping online see web site

P.O. Box 350166, Brooklyn, New York 11235-0003 (718) 934-4500 Fax (718) 332-4661 The Design Engineers Search Engine Provides ACTUAL Data Instantly at minicircuits.com

Notes: 1. Performance and quality attributes and conditions not expressly stated in this specification sheet are intended to be excluded and do not form a part of this specification sheet. 2. Electrical specifications and performance data contained herein are based on Mini-Circuit's applicable established test performance criteria and measurement instructions. 3. The parts covered by this specification sheet are subject to Mini-Circuits standard limited warranty and terms and conditions (collectively, "Standard Terms"); Purchasers of this part are entitled to the rights and benefits contained therein. For a full statement of the Standard Terms and the exclusive rights and remedies thereunder, please visit Mini-Circuits' website at www.minicircuits.com/MCLStore/terms.jsp.