

Product Features

- GaAs Power Doubler
- Extremely Low Distortion
- Guaranteed Broadband Power Gain
- Heat Sink 99.9% Copper, & Gold Plated
- Excellent Thermal Conductivity
- Single Supply Voltage @ 24V
- Low DC Power Consumption
- Optimal Reliability

Applications

- CATV Trunk Amplifier
- Optical Drive Amplifier



Package Type : SOT-115J

Description

Hybrid Power Doubler amplifier for CATV Systems up to 870MHz in frequency.

This hybrid amplifier module operates with a single voltage supply of 24V(DC), and use GaAs MMIC technology.

Electrical Specifications @ $V_{CC} = 24V$; $T_{case} = 25^{\circ}C$; $Z_S = Z_L = 75\Omega$

PARAMETER	UNIT	MIN	TYP	MAX	SYMBOL	CONDITION
Operating Frequency	MHz	45	-	870	f_o	-
Power Gain	dB	18.0	-	19.0	G_p	f = 45 MHz
		19.0	-	20.5		f = 870 MHz
Slope Cable Equivalent	dB	-	1.0	-	SL	f = 45 ~ 870 MHz
Flatness of Frequency Response	dB	-	-	0.5	FL	f = 45 ~ 870 MHz
Input Return Loss	dB	20.0	-	-	S_{11}	f = 45 ~ 80 MHz
		20.0	-	-		f = 80 ~ 160 MHz
		19.0	-	-		f = 160 ~ 320 MHz
		18.0	-	-		f = 320 ~ 640 MHz
		18.0	-	-		f = 640 ~ 870 MHz
Output Return Loss	dB	20.0	-	-	S_{22}	f = 45 ~ 80 MHz
		20.0	-	-		f = 80 ~ 160 MHz
		19.0	-	-		f = 160 ~ 320 MHz
		18.0	-	-		f = 320 ~ 640 MHz
		18.0	-	-		f = 640 ~ 870 MHz
Noise Figure	dB	-	5.1	-	F	f = 45 MHz
		-	5.7	-		f = 550 MHz
		-	6.2	-		f = 750 MHz
		-	6.6	-		f = 870 MHz
Total Current Consumption (DC)	mA	380	400	420	I_{tot}	-

Distortion @ $V_{CC} = 24V$; $T_{case} = 25^{\circ}C$; $Z_S = Z_L = 75\Omega$

PARAMETER	UNIT	MIN	TYP	MAX	SYMBOL	CONDITION
Frequency	MHz	45	-	870	f	-
Composite Triple Beat	dBc	-	-65	-61	CTB	135 channel flat; $V_o = 44dBmV$
Cross Modulation	dBc	-	-66	-63	XMOD	135 channel flat; $V_o = 44dBmV$
Composite Second Order Distortion	dBc	-	-70	-65	CSO	135 channel flat; $V_o = 44dBmV$

Note

135 Channels, NTSC frequency raster: 55.25MHz ~ 859.25MHz, 44dBmV flatted Output level.
CTB, XMOD, CSO definitions follow NCTA definition.

Absolute Maximum Ratings

PARAMETER	UNIT	MIN	MAX	SYMBOL	CONDITION
RF Input Voltage	dBmV	-	70	V_i	Single Tone
DC Supply Over Voltage	V	-	28	V	5 minutes
Storage Temperature	$^{\circ}C$	-40	100	T_{stg}	-
Operating Mounting Base Temperature	$^{\circ}C$	-20	100	T_{mb}	-

Quick Reference Data

PARAMETER	UNIT	MIN	MAX	SYMBOL	CONDITION
Power Gain	dB	18.0	19.0	G_p	f = 50 MHz
		19.0	20.5		f = 870 MHz
Total Current Consumption (DC)	mA	-	420	I_{tot}	$V_{cc} = 24V$

Functional Diagram

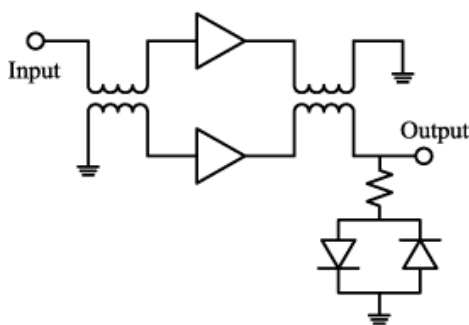

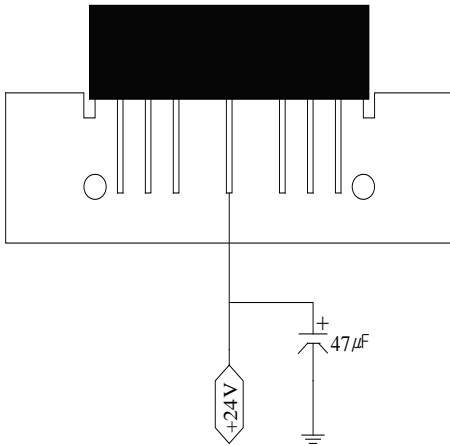
Note for Correct Use

1. On the power input port (Pin#5), 47µF/35V capacitor GND is recommended.
2. The heat sink of CATV Hybrids is to be mounted in direct contact with the metal case of the equipment. Heat conducting grease should be applied to the module/equipment interface and the unit tightly secured.
3. Put the power off before adjusting in/output matching of the system.
4. The unit must have a common ground with the equipment and the analyzer.
5. Pay close attention to the input voltage not to over power the hybrid.
6. The space between bottom of socket and the tip of the lead is recommended to have space of 2mm+ to protect the pin
7. Do not open the plastic cover to change the matching inside the hybrid. Once opened, RFHIC will not be responsible for the hybrid.

ESD Protection

Gallium Arsenide Integrated Circuits are sensitive to electrostatic discharge (ESD) and can be damaged by static electricity. Proper ESD control techniques should be used when handling these devices. Some of the precautions recommended are;

- Person at a workbench should be earthed via a wrist strap and a resistor.
- All mains-powered equipment should be connected to the mains via an earth-leakage switch.
- Equipment cases should be grounded.
- Relative humidity should be maintained between 40% and 50%.
- An ionizer is recommended.
- Keep static materials, such as plastic envelopes and plastic trays etc. away from the workbench.

Package Dimensions (Type: SOT-115J)

* Unit: mm[inch] | Tolerance: ±0.2[.008]

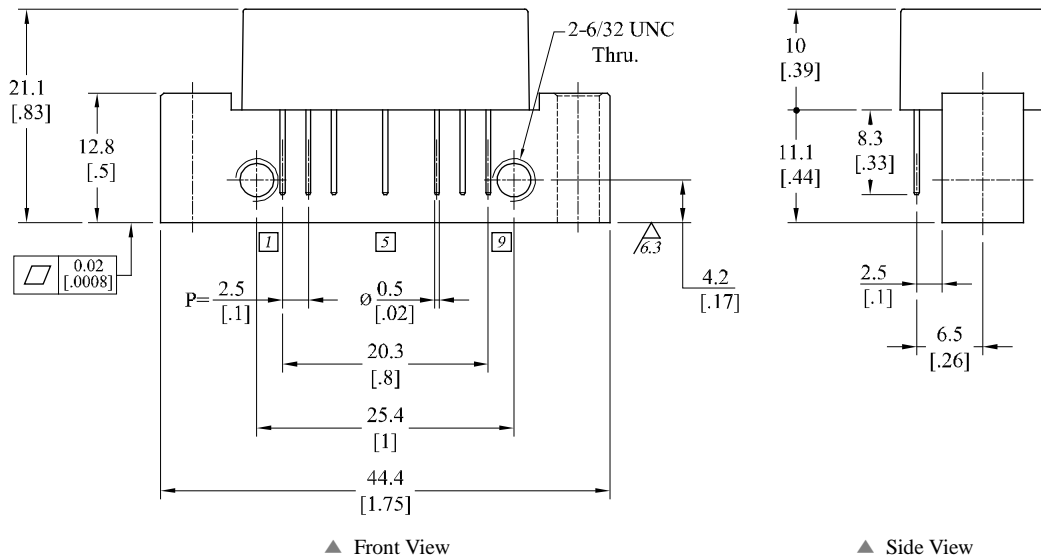
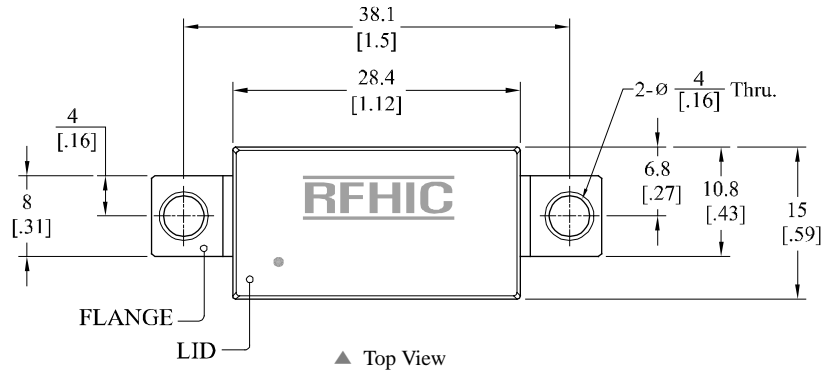

Pin Description					
Pin No	Function	Pin No	Function	Pin No	Function
1	RF Input	4	-	7	GND
2	GND	5	Vcc	8	GND
3	GND	6	-	9	RF Output

Revision History

Part Number	Release Date	Version	Modification	Data Sheet Status
2F8719DS	2012.9.5	5.4	-	-

RFHIC Corporation reserves the right to make changes to any products herein or to discontinue any product at any time without notice. While product specifications have been thoroughly examined for reliability, RFHIC Corporation strongly recommends buyers to verify that the information they are using is accurate before ordering. RFHIC Corporation does not assume any liability for the suitability of its products for any particular purpose, and disclaims any and all liability, including without limitation consequential or incidental damages. RFHIC products are not intended for use in life support equipment or application where malfunction of the product can be expected to result in personal injury or death. Buyer uses or sells such products for any such unintended or unauthorized application, buyer shall indemnify, protect and hold RFHIC Corporation and its directors, officers, stockholders, employees, representatives and distributors harmless against any and all claims arising out of such unauthorized use.

Sales, inquiries and support should be directed to the local authorized geographic distributor for RFHIC Corporation. For customers in the US, please contact the US Sales Team at 919-677-8780. For all other inquiries, please contact the International Sales Team at 82-31-250-5078.