

# Analog Devices Welcomes Hittite Microwave Corporation

NO CONTENT ON THE ATTACHED DOCUMENT HAS CHANGED



**THIS PAGE INTENTIONALLY LEFT BLANK**



## HIGH ISOLATION SPST SWITCH MODULE, DC - 20 GHz



### Typical Applications

The HMC-C019 is ideal for:

- Basestation Infrastructure
- Fiber Optics & Broadband Telecom
- Microwave Radio & VSAT
- Military Radios, Radar, & ECM
- Test Instrumentation

### Functional Diagram

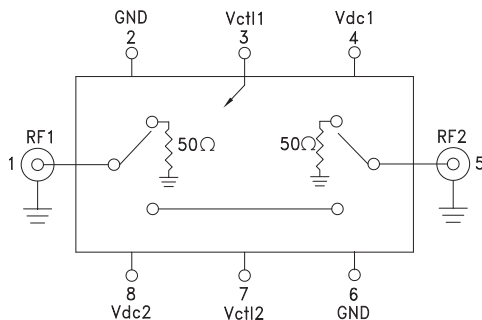

### Features

- High Isolation: 100 dB up to 4 GHz  
65 dB up to 20 GHz
- Low Insertion Loss: 3.5 dB @ 10 GHz  
4.0 dB @ 16 GHz
- Fast Switching RF Pulse Modulator
- Non-Reflective Topology
- Hermetically Sealed Module
- Field Replaceable SMA connectors
- 55 °C to +85 °C Operating Temperature

### General Description

The HMC-C019 is a high speed, high isolation GaAs MESFET SPST switch housed in a miniature hermetic module with field replaceable SMA connectors. Covering DC to 20 GHz, the switch features 100 dB isolation up to 4 GHz and 65 dB isolation up to 20 GHz. CMOS interface allows a positive +5V bias voltage at very low DC currents. This non-reflective switch exhibits very fast switching speeds, with very low switching transients making it ideal for high speed RF pulse modulation applications.

### Electrical Specifications

$T_A = +25^\circ \text{C}$ , With  $V_{dc1}$ ,  $V_{dc2} = +5\text{V}$  &  $0/+5\text{V}$  Control, 50 Ohm System

Parameter	Frequency	Min.	Typ.	Max.	Units
Insertion Loss	DC - 4 GHz		3.0	3.5	dB
	DC - 16 GHz		4.0	5.5	dB
	DC - 20 GHz		6.0	9.0	dB
Isolation	DC - 4 GHz	90	100		dB
	DC - 10 GHz	75	80		dB
	DC - 16 GHz	70	75		dB
	DC - 20 GHz	60	65		dB
Return Loss RF1 & RF2	"On State & Off State"	DC - 12 GHz	12		dB
		DC - 20 GHz	8		dB
Input Power for 1 dB Compression	0.5 - 20 GHz	20	23		dBm
Input Third Order Intercept (Two-Tone Input Power= +7 dBm Each Tone)	0.5 - 10 GHz		45		dBm
	0.5 - 20 GHz		43		dBm
Switching Characteristics tRISE, tFALL (10/90% RF) tON, tOFF (50% CTL to 10/90% RF)	DC - 20 GHz		2.5		ns
			8.5		ns
Switching Transients	DC - 20 GHz		20		mVpp

For price, delivery, and to place orders, please contact Hittite Microwave Corporation:  
20 Alpha Road Chelmsford, MA 01824 Phone: 978-250-3343 Fax: 978-250-3373  
Order Online at [www.hittite.com](http://www.hittite.com)

## HIGH ISOLATION SPST SWITCH MODULE, DC - 20 GHz



**Insertion Loss**

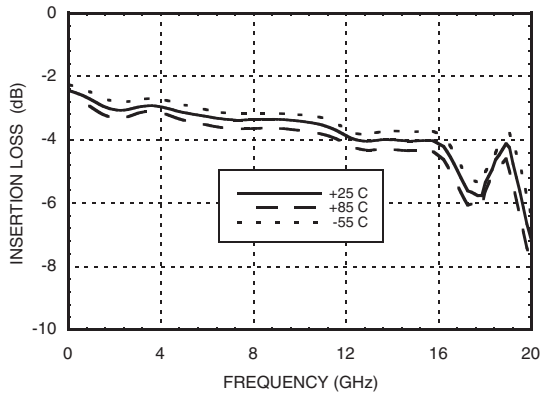

**Isolation**

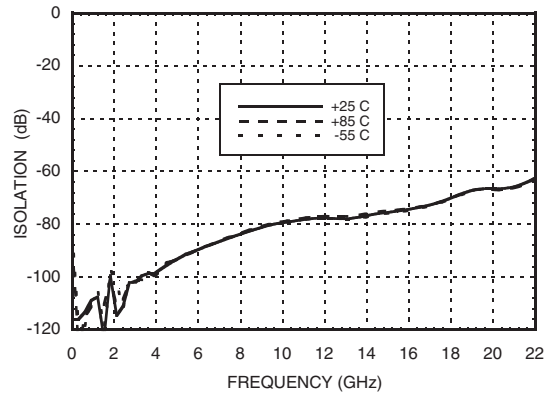

**Return Loss**

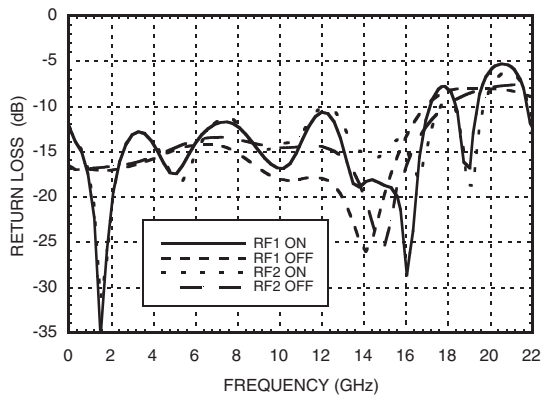

**Input P0.1dB & P1dB Compression Point**

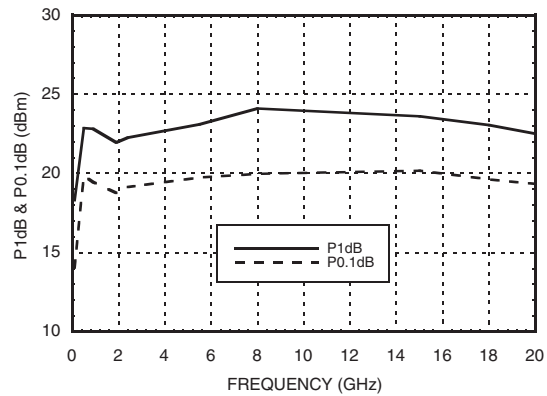

**Input Third Order Intercept Point**

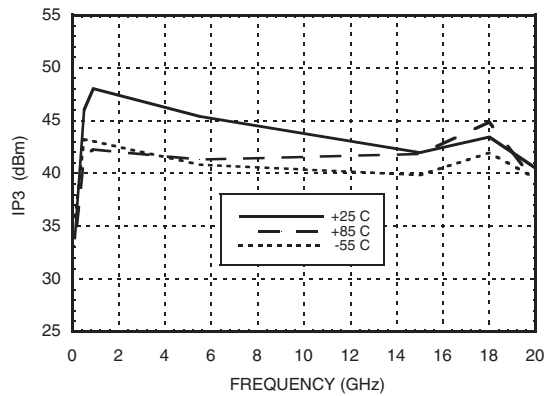



## HIGH ISOLATION SPST SWITCH MODULE, DC - 20 GHz

### Absolute Maximum Ratings

RF Input Power	+27 dBm
Supply Voltage (Vdc1, Vdc2)	+7V
Control Voltage Range (Vctl1, Vctl2)	-0.5V to Vdd +0.5V
Hot Switch Power Level	+23 dBm
Storage Temperature	-65 to +150 °C
Operating Temperature	-55 to +85 °C



**ELECTROSTATIC SENSITIVE DEVICE  
OBSERVE HANDLING PRECAUTIONS**

### Control Voltages Vctl1 & Vctl2

State	Bias Condition
High	+3.5 to Vdc @ 1 mA Typ.
Low	0 to +1.5V @ 20 µA Typ.

### Truth Table



Control Input (Vctl1 & Vctl2)	RF1 to RF2 Path
High	On
Low	Off

### Bias Voltage & Current

Vdc Range = +5 Vdc ± 10%	
Vdc1 & Vdc2 (V)	Idc (Typ.) (mA)
+5	2.8

(Bias current increases with switching rate to 15 - 20 mA.)

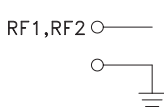
### Pin Descriptions

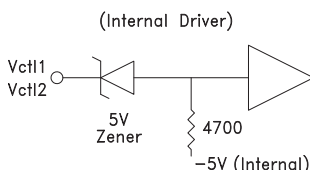
Pin Number	Function	Description	Interface Schematic
1, 5	RF1, RF2	RF connector, SMA female, field replaceable. These pins are DC coupled and matched to 50 Ohms. DC blocking capacitors are required if external RF line potential is not equal to 0V.	
2, 6	GND	Power supply ground.	
3, 7	Vctl1, Vctl2	CMOS interface, control voltages per table. Requires active pullup to +5V.	
4, 8	Vdc1, Vdc2	Supply voltage (+5V ±10%)	

## HIGH ISOLATION SPST SWITCH MODULE, DC - 20 GHz



### Outline Drawing

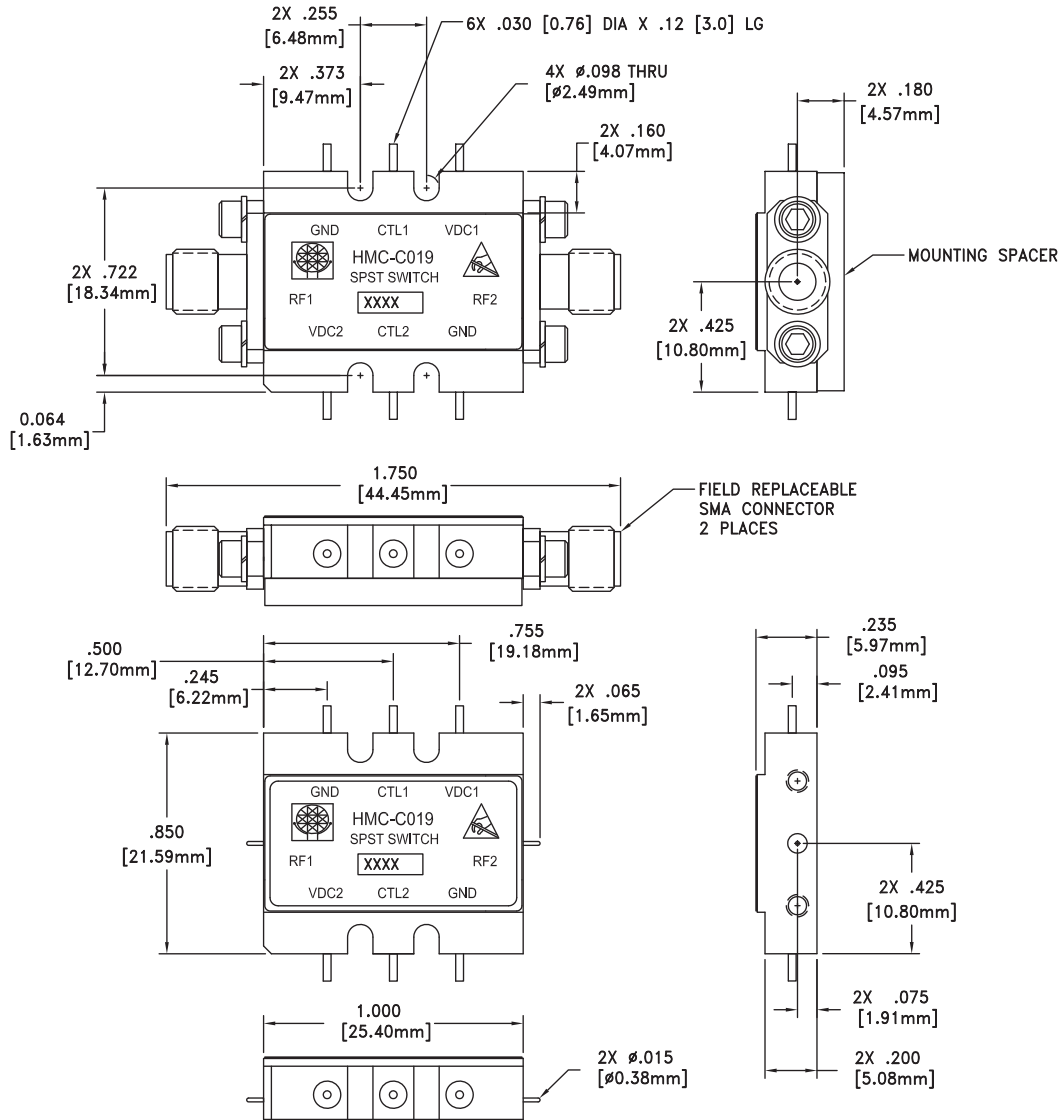

VIEW SHOWN WITH CONNECTORS REMOVED

### Package Information

Package Type	C-9
Package Weight <sup>[1]</sup>	18.7 gms <sup>[2]</sup>
Spacer Weight	3.3 gms <sup>[2]</sup>

[1] Includes the connectors

[2] ±1 gms Tolerance

#### NOTES:

- 1.0 PACKAGE, LEADS, COVER MATERIAL: KOVAR™
- 2.0 FINISH: GOLD PLATE OVER NICKEL PLATE
- 3.0 ALL DIMENSIONS ARE IN INCHES [MILLIMETERS].
- 4.0 TOLERANCES:
- 4.1 .XX = %P.02
- 4.2 .XXX = %P.010
- 5.0 MARK LOT NUMBER ON .080 X .250 LABEL WHERE SHOWN, WITH .030 MIN TEXT HEIGHT.
- 6.0 MOUNTING SPACER PART NUMBER 111532.