

- **Excellent Size-to-Performance Ratio**
- **Hermetic 13.3 x 6.5 mm Surface-mount Case**
- **Complies with Directive 2002/95/EC (RoHS)**



**Absolute Maximum Ratings**

Rating	Value	Units
Maximum Incident Power in Passband	+10	dBm
Maximum DC Voltage Between any Two Terminals	30	VDC
Storage Temperature Range in Tape and Reel	-40 to +85	°C
Suitable for Lead-free Soldering - Maximum Soldering Profile	260°C for 30 s	

**SF2063A**

**156 MHz  
SAW Filter**

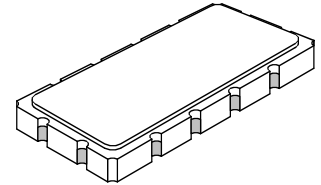

**SMP-53**

**Electrical Characteristics**

Characteristic	Sym	Notes	Min	Typ	Max	Units
Nominal Center Frequency	$f_C$	1	156.00			MHz
Insertion Loss at $f_C$	IL			15.5	18	dB
Amplitude Ripple				1.1	2.0	dB <sub>P-P</sub>
1.5 dB Bandwidth	BW <sub>1.5</sub>		9.4	10		MHz
Rejection Referenced to IL						
50 to 149 MHz			39	45		dB
165 to 500 MHz			39	45		
Operating Temperature Range	T <sub>A</sub>		-40		+85	°C

Impedance Matching to 50Ω Unbalanced	External L-C
Case Style	SMP-53 13.3 x 6.5 mm Nominal Footprint
Lid Symbolization (YY = year, WW = week)	RFM SF2063A YYWW

**Electrical Connections**

Connection	Terminals
Port 1 Hot	11
Port 1 Gnd Return	12
Port 2 Hot	5
Port 2 Gnd Return	6
Case Ground	All others



**CAUTION: Electrostatic Sensitive Device. Observe precautions for handling.**

**NOTES:**

1. Unless noted otherwise, all specifications apply over the operating temperature range with filter soldered to the specified demonstration board with impedance matching to 50 Ω and measured with 50 Ω network analyzer.
2. Unless noted otherwise, all frequency specifications are referenced to the nominal center frequency,  $f_C$ .
3. The design, manufacturing process, and specifications of this filter are subject to change.
4. US and international patents may apply.

# SF2063A $S_{11}$ , $S_{22}$ and Amplitude Response

8 Mar 2006 16:19:43

CH1 S11 1 UFS  
 1: 35.279  $\Omega$  20.383  $\Omega$  20.795 nH  
 156.000 000 MHz  
 SF2063A DEMO BOARD

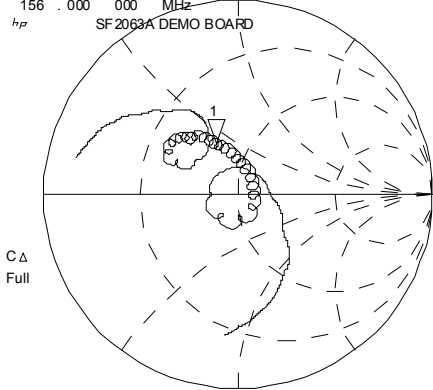

CENTR 156.000 MHz SPAN 32.000 MHz

CH3 S22 1 UFS  
 1: 47.971  $\Omega$  -4.7188  $\Omega$  216.21 pF  
 156.000 000 MHz

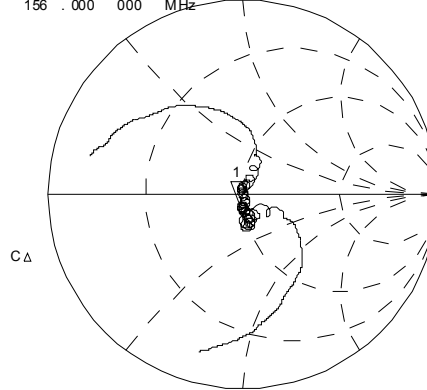

CENTR 156.000 MHz SPAN 32.000 MHz

CH2 S21 LOG 10 dB/ REF -20 dB 3: .66240 dB 9.400 000 MHz

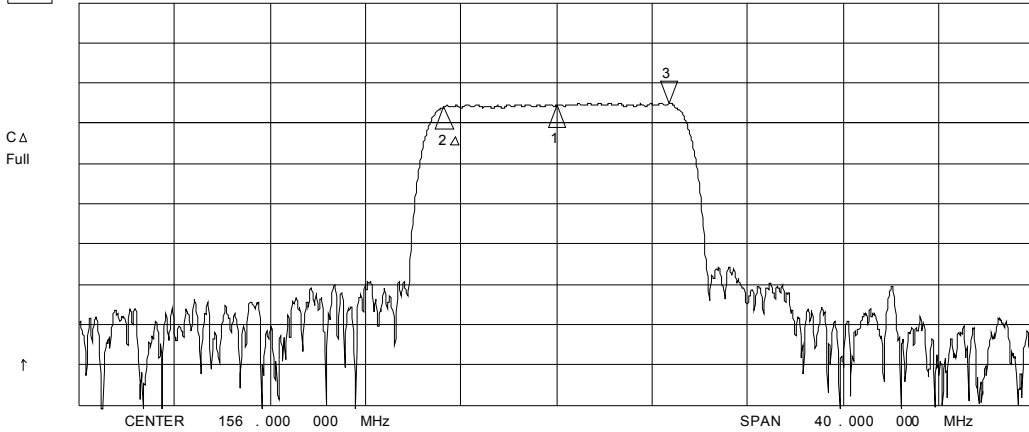

CH2 Markers  
 $\Delta$  REF=2  
 mean : -15.645 dB  
 s. dev : .25400 dB  
 p-p : 1.0964 dB

# SF2063A Passband Group Delay and Amplitude Ripple

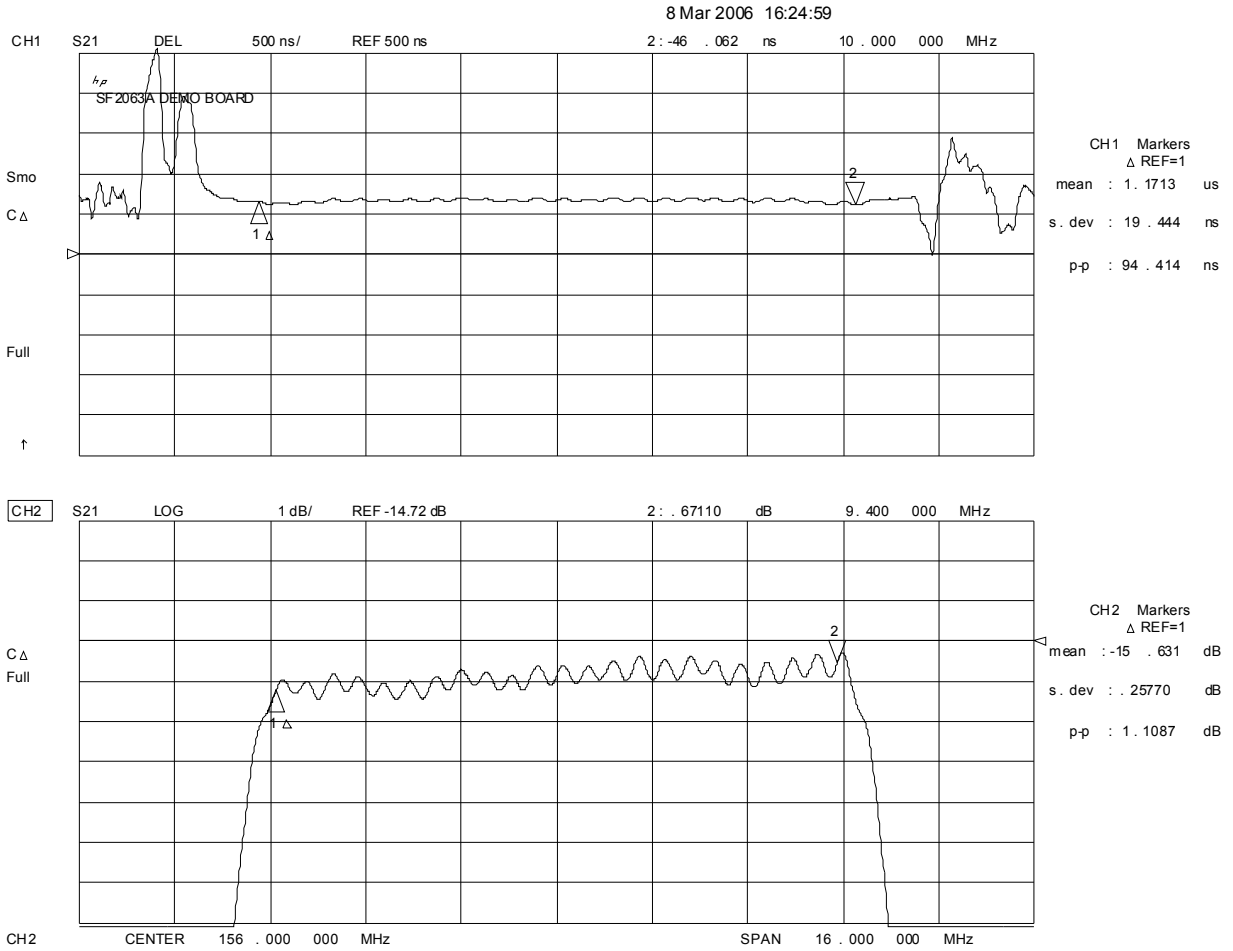

## SF2063A Matching Components

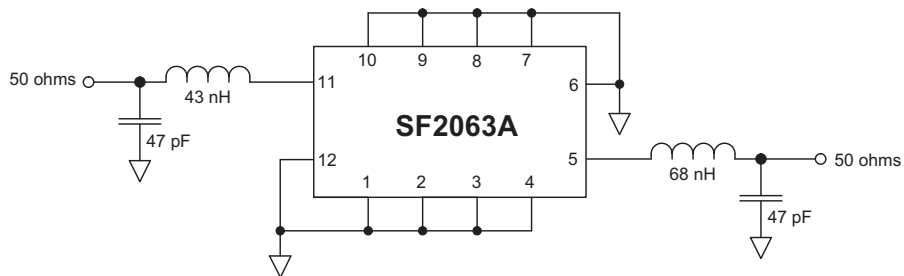

# SMP-53 Case

## 12-Terminal Ceramic Surface-Mount Case 13.3 x 6.5 mm Nominal Footprint

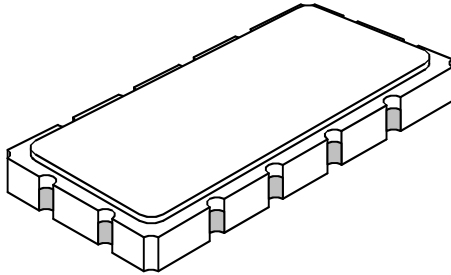

### Case Dimensions

Dimension	mm			Inches		
	Min	Nom	Max	Min	Nom	Max
A	13.08	13.31	13.60	0.515	0.524	0.535
B	6.27	6.50	6.80	0.247	0.256	0.268
C		1.91	2.00		0.075	0.079
D		1.50			0.059	
E		0.79			0.031	
H		1.0			0.039	
P		2.54			0.100	

### Electrical Connections

Connection		Terminals
Port 1	Input or Return	11
	Return or Input	12
Port 2	Output or Return	5
	Return or Output	6
Ground		All others
Single-ended Operation		Return is ground
Differential Operation		Return is hot

### Materials

Solder Pad Plating	0.3 to 1.0 $\mu\text{m}$ Gold over 1.27 to 8.89 $\mu\text{m}$ Nickel
Lid Plating	2.0 to 3.0 $\mu\text{m}$ Nickel
Body	$\text{Al}_2\text{O}_3$ Ceramic
Pb Free	

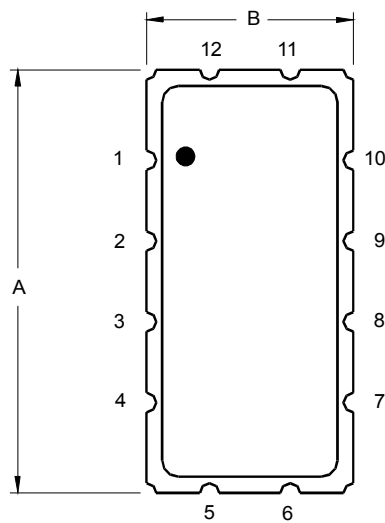

TOP VIEW

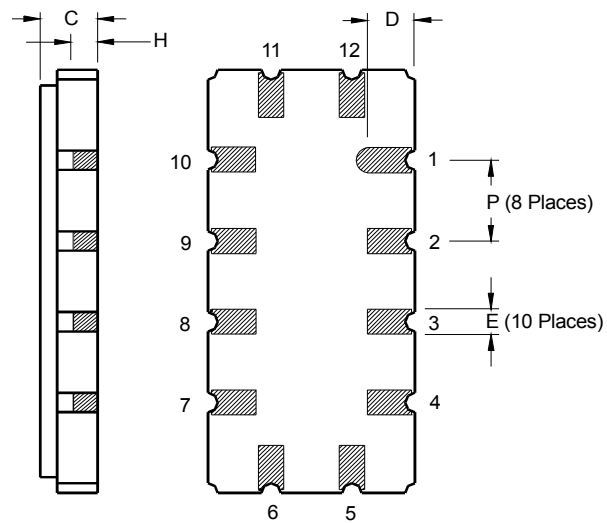

BOTTOM VIEW