

## Product Features

- 30 ~ 2650MHz
- GaAs E-pHEMT MMIC
- Higher linearity
- Low Noise Figure
- High Max input power
- SOT-89 SMD Type package
- Higher productivity
- Lower manufacturing cost
- Pb Free / RoHS Standard

## Applications

- Receiver IF Amplifier
- Cellular, GSM, RFID
- Base station
- RF Sub-system
- CATV, Tetra, Satellite system



Package Type : SOT-89

## Description

AE305 is a drive or pre-drive amplifier designed in a low cost SOT-89 package.

This MMIC is based on Gallium Arsenide Enhancement Mode pHEMT which shows low current and high IP3.

It is designed as driver devices for infrastructure equipment in the 30~2650MHz Wireless technologies such as IF, Cellular, GSM System. The data in this spec sheet is valid only for 50 ohm application.

## Electrical Specifications

PARAMETER	UNIT	MIN	TYP	MAX	TYP	REMARK
Operating Frequency(fo)	MHz	30	-	2650	-	-
Small Signal Gain(S <sub>21</sub> )	dB	-	14.5 13.5	-	14 13	30~1000MHz 30~2650MHz
Input Return Loss(S <sub>11</sub> )	dB	-	-13	-	-11	-
Output Return Loss(S <sub>22</sub> )	dB	-	-14	-	-12	-
Output IP3(OIP3)	dBm	35	38	-	30	-
1dB Compression Point(P <sub>1dB</sub> )	dBm	20	22	-	17	-
Noise Figure(NF)	dB	-	2.5	-	2.6	-
DC Current	mA	-	110	-	48	-
Supply Voltage	V	-	5	-	3.3	-

### Note

1. Test conditions unless otherwise noted. Freq=500MHz, Vdd=+5V, T=25°C, 50Ω system
2. OIP3 measured with 2 tones at an output power of +5dBm/tone separated by 1MHz

## Absolute Maximum Ratings

PARAMETER	UNIT	MIN	TYP	MAX	REMARK
Device Voltage	V	-	5	7	-
Operating Case Temperature	°C	-40	-	85	-
Storage Temperature	°C	-40	-	150	-
ESD Human Body Model	-	-	Class 1A	-	-
Moisture Sensitivity Level	-	-	MSL1	-	-
Junction Temperature (T <sub>j</sub> )	°C	-	-	180	@ quiescent current, No RF, T <sub>c</sub> = 85°C
Thermal Resistance (R <sub>th</sub> )	°C/W	-	70	-	

Application Circuit @ 30 ~ 1000MHz, 50ohm System

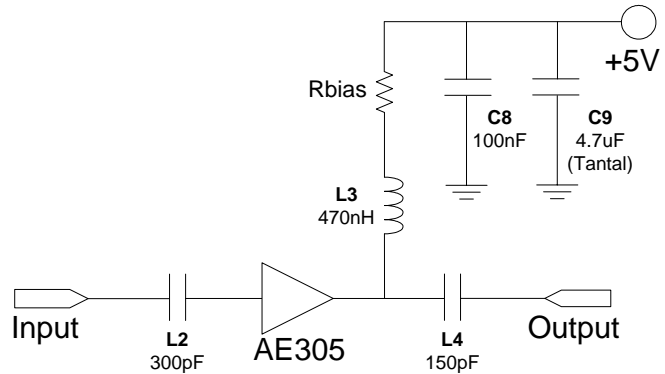
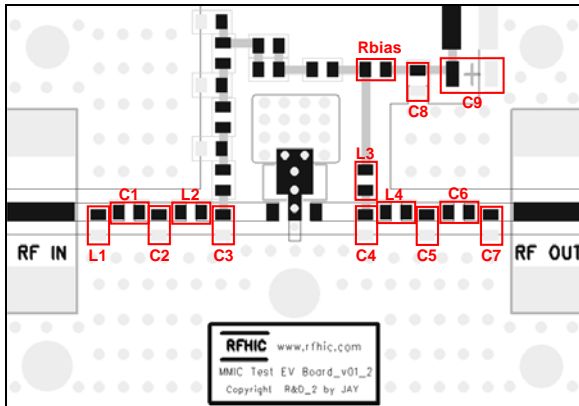

EVB BOM			
Description	Reference Designator	Manufacturer	Manufacturer's P/N
CAP, 150pF, 1608	L4	Murata	GRM1885C1H151JA01D
CAP, 300pF, 1608	L2	Murata	GRM1885C1H301JA01D
CAP, 100nF, 1608	C8	Murata	GRM188R71C104KA01D
CAP, 4.7uF, 3216-18	C9	AVX	TAJA475M016RNJ
IND, 470nH, ±10%, 2520, W/W	L3	Taiyo Yuden	LEM2520TR47K
RES, 0Ohm, 1608	C1, C6, Rbias	ROHM	MCR03 EZPJ000
DNP	L1, C2, C3, C4, C5, C7	-	-

Typical Performance

PARAMETER	UNIT	TYPICAL		
Operational Frequency Range	MHz	50	500	1000
Small Signal Gain(S21)	dB	14.5		
Input Return Loss(S11)	dB	-8	-17	-15
Output Return Loss(S22)	dB	-12	-25	-18
Output IP3(OIP3)	dBm	38	38.5	35
1dB Compression Point(P <sub>1</sub> dB)	dBm	20	22	21
Noise Figure(NF)	dB	2.4	2.5	2.8

Note

1. Test conditions unless otherwise noted. Freq=30~1000MHz, Vdd=+5V, T=25 °C, 50Ω system
2. OIP3 measured with 2 tones at an output power of +5dBm/tone separated by 1MHz

Recommended Bias Resistor Values

Vsupply	Rbias(5V)	Rbias(4.5V)	Rbias(4V)
5V	0Ω	5.6Ω	12Ω
Current	110mA	92mA	75mA

Typical Performance @ Voltage = 5V, T=25°C, 50ohm System (Rbias)

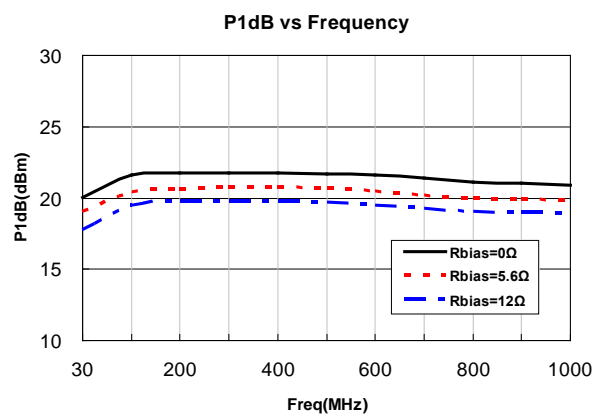
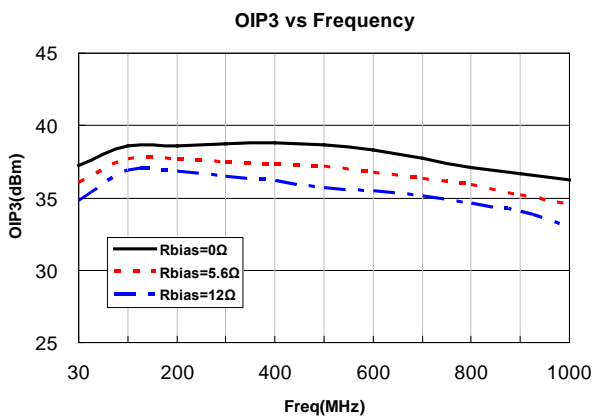
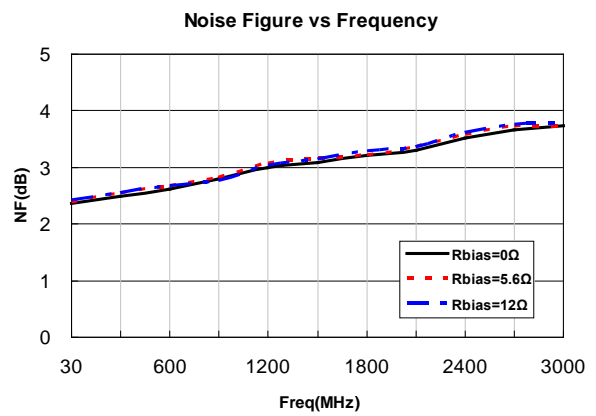
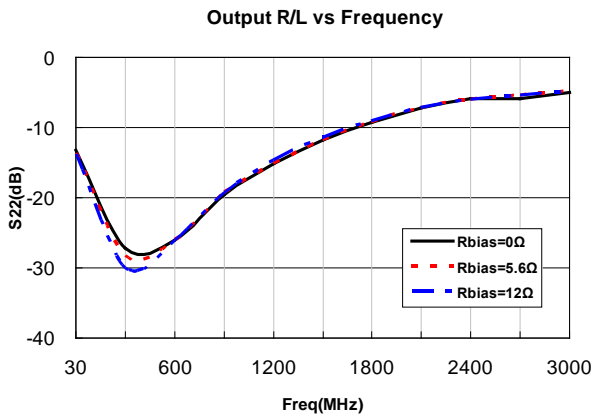
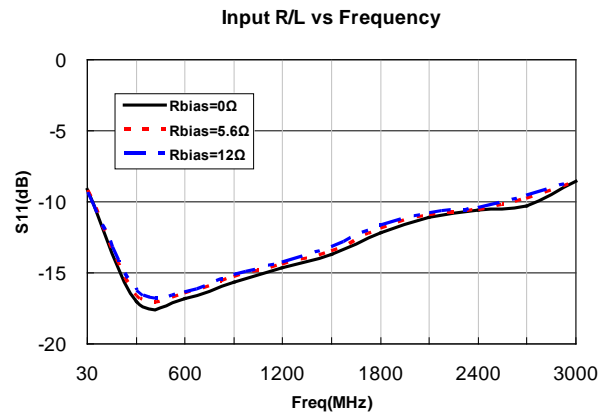
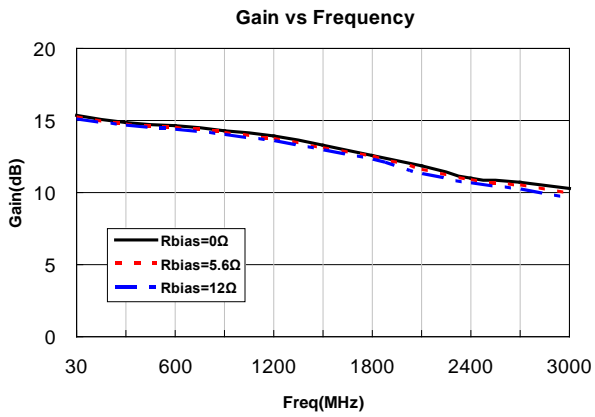

Typical Performance @ Voltage = 5V(110mA) & 3.3V(48mA), T=25°C, 50ohm System

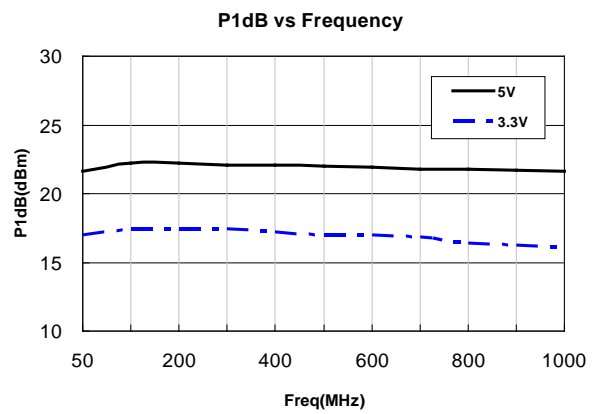
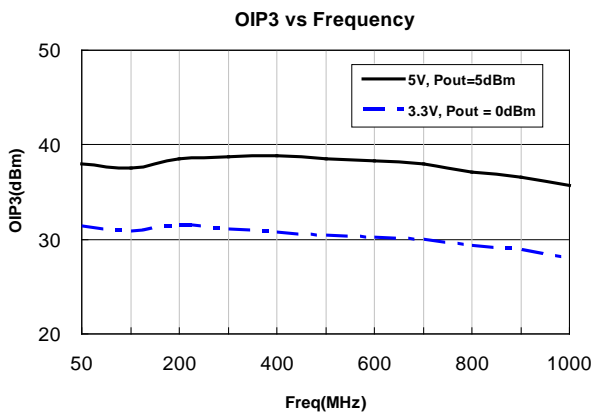
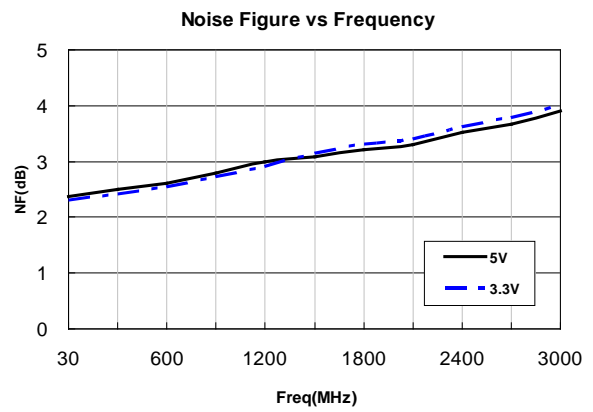
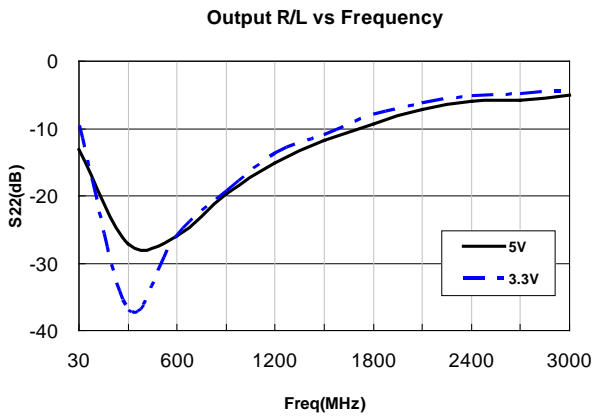
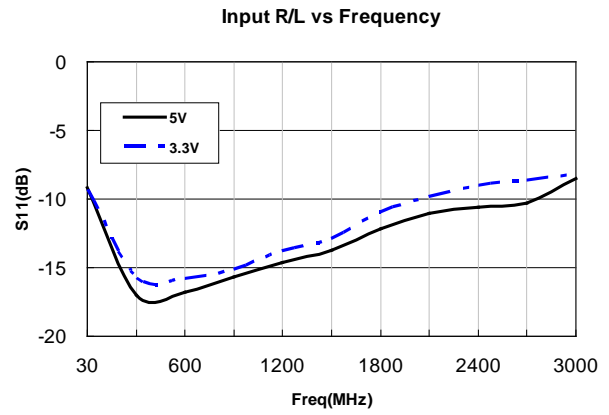
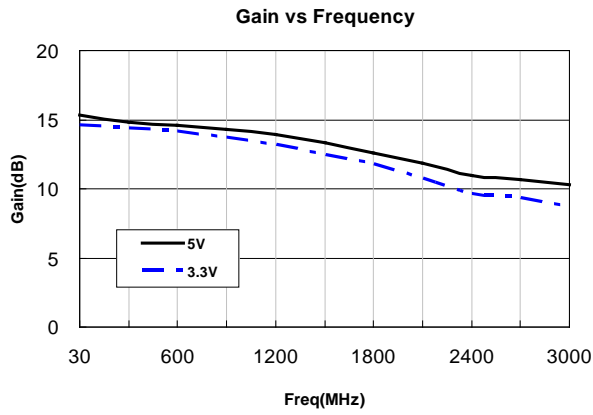

Typical Performance @ Voltage = 5V, 50ohm System(Temperature)

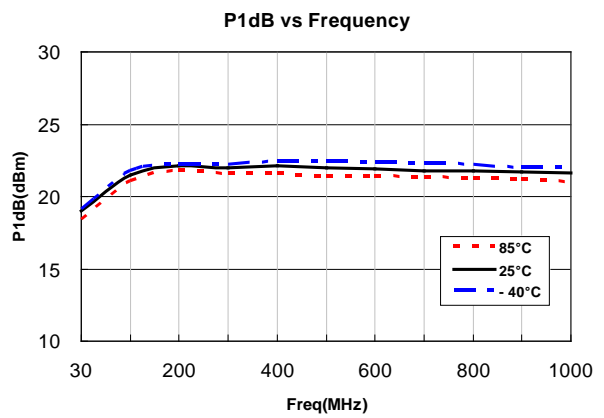
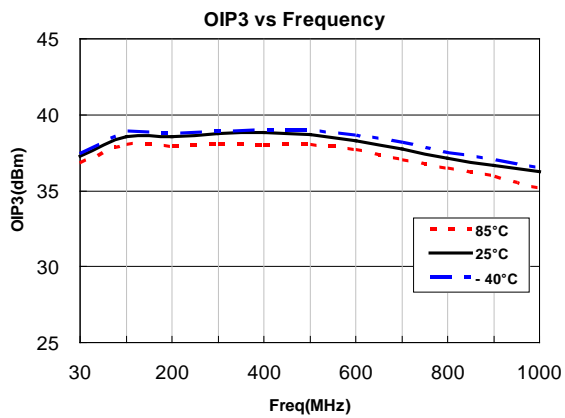
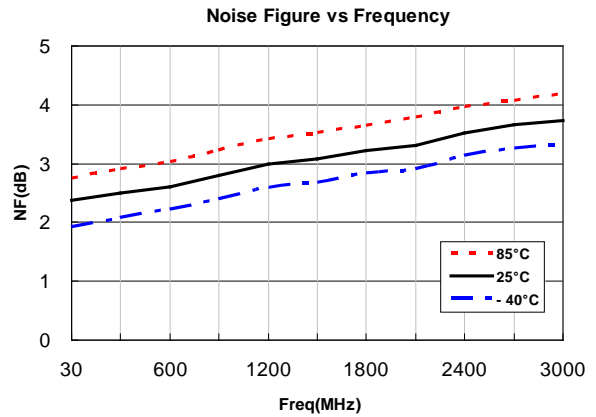
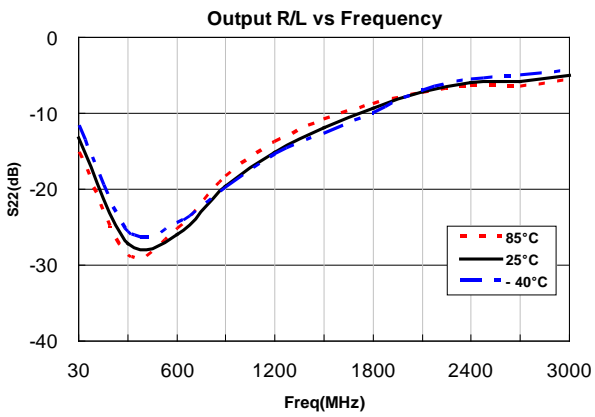
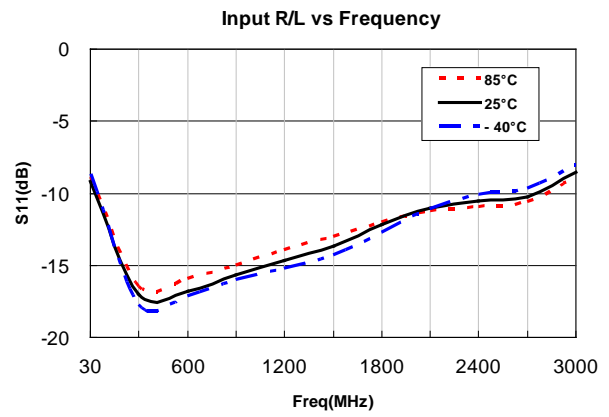
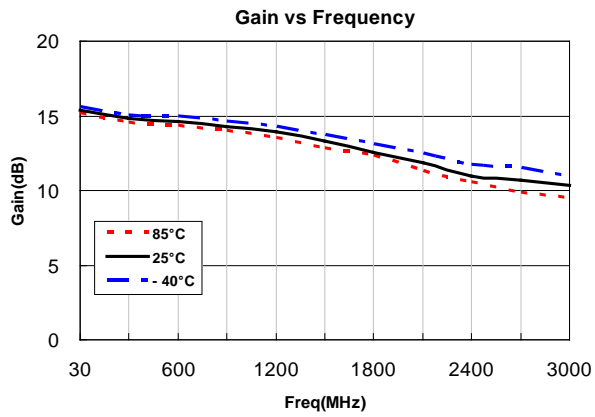

Application Circuit @ 30 ~ 2650MHz, 50ohm System

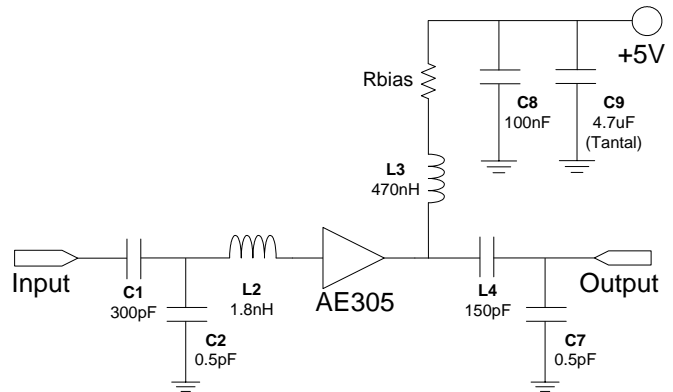
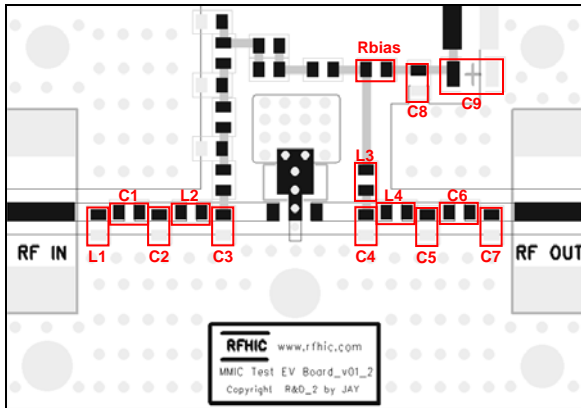

EVB BOM			
Description	Reference Designator	Manufacturer	Manufacturer's P/N
CAP, 0.5pF, 1608	C2, C7	Murata	GRM1885C1HR50CZ01D
CAP, 150pF, 1608	L4	Murata	GRM1885C1H151JA01D
CAP, 300pF, 1608	C1	Murata	GRM1885C1H301JA01D
CAP, 100nF, 1608	C8	Murata	GRM188R71C104KA01D
CAP, 4.7uF, 3216-18	C9	AVX	TAJA475M016RNJ
IND, 1.8nH, 1608	L2	Taiyo Yuden	HK1608 1N8S
IND, 470nH, ±10%, 2520, W/W	L3	Taiyo Yuden	LEM2520TR47K
RES, 00ohm, 1608	C6, Rbias	ROHM	MCR03 EZPJ000
DNP	L1, C3, C4, C5	-	-

Typical Performance

PARAMETER	UNIT	TYPICAL			
		50	1000	2000	2650
Operational Frequency Range	MHz	50	1000	2000	2650
Small Signal Gain(S21)	dB	13.5			
Input Return Loss(S11)	dB	-8	-13	-17	-13
Output Return Loss(S22)	dB	-13	-14	-10	-8
Output IP3(OIP3)	dBm	38.5	35.5	34.5	29.5
1dB Compression Point(P <sub>1</sub> dB)	dBm	20	22	21.5	17
Noise Figure(NF)	dB	2.5	2.8	3.3	4

Note

1. Test conditions unless otherwise noted. Freq=30~2650MHz, Vdd=+5V, T=25 °C, 50Ω system
2. OIP3 measured with 2 tones at an output power of +5dBm/tone separated by 1MHz

Recommended Bias Resistor Values

Vsupply	Rbias(5V)	Rbias(4.5V)	Rbias(4V)
5V	0Ω	5.6Ω	12Ω
Current	110mA	92mA	75mA

Typical Performance @ Voltage = 5V, T=25°C, 50ohm System (Rbias)

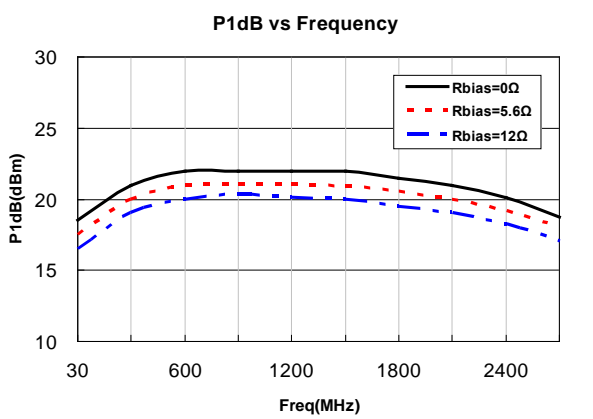
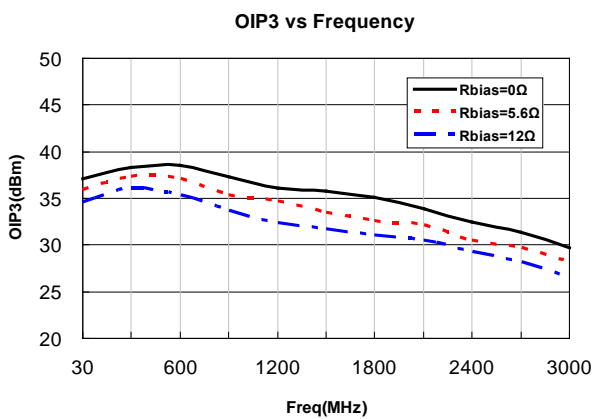
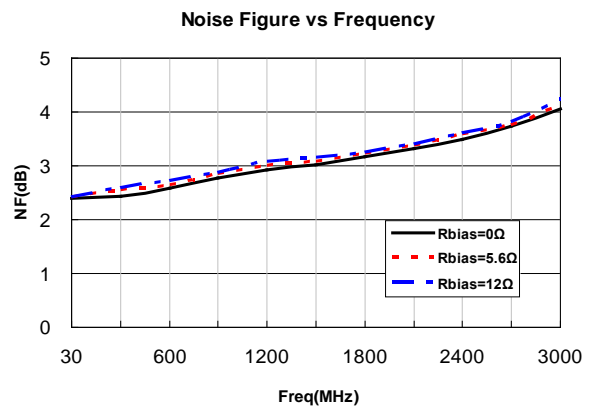
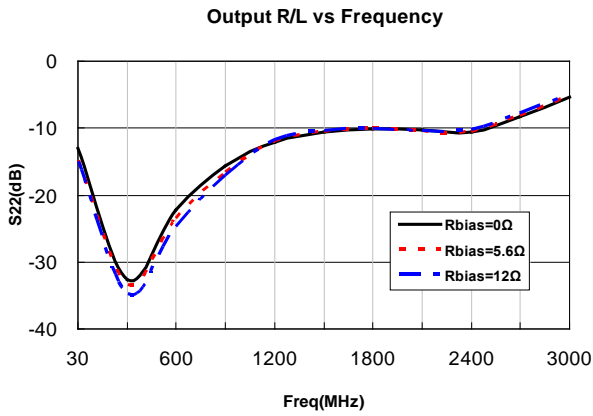
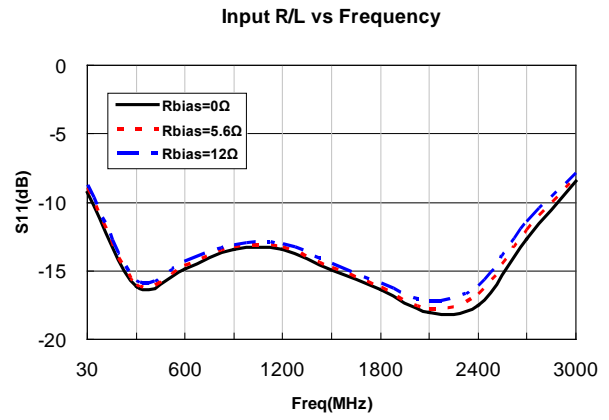
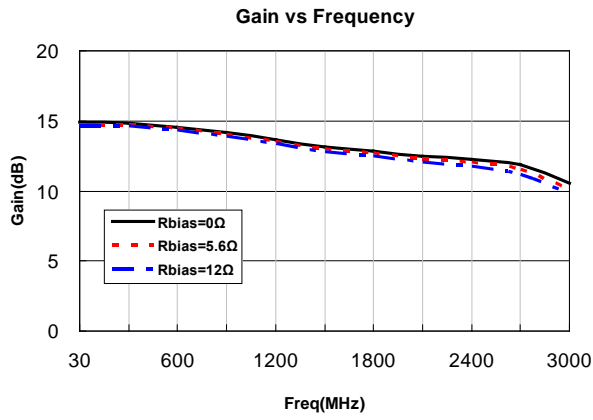

Typical Performance @ Voltage = 5V(110mA) & 3.3V(48mA), T=25°C, 50ohm System

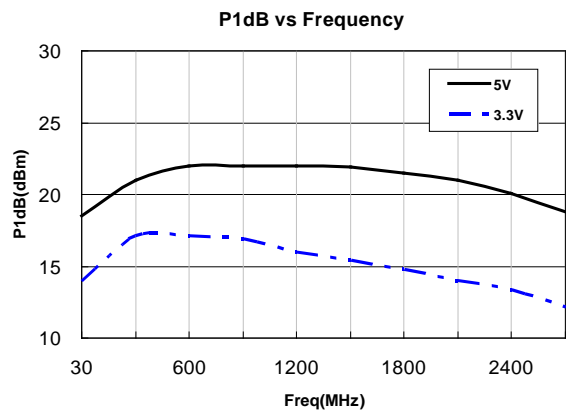
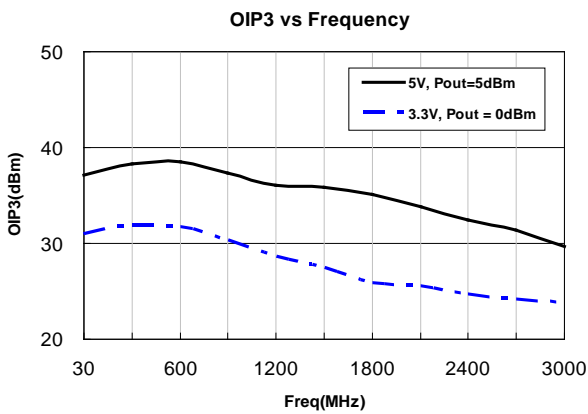
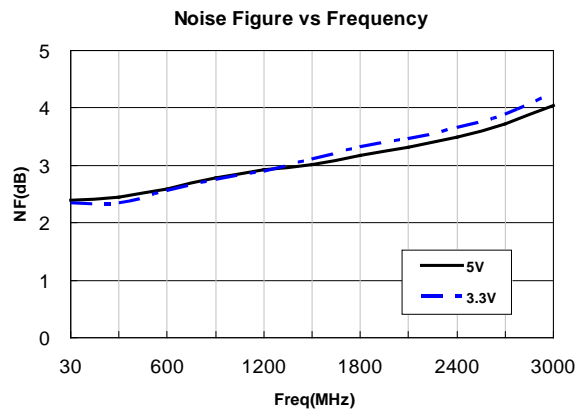
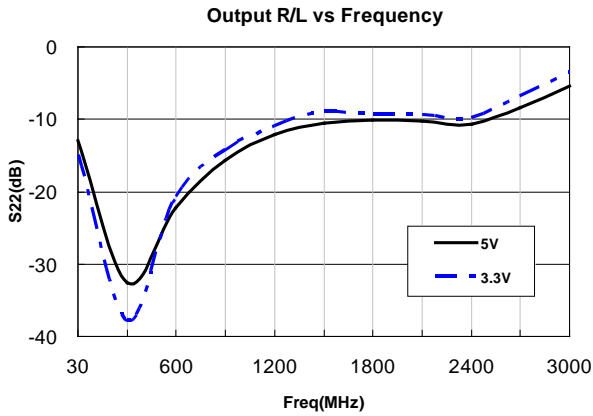
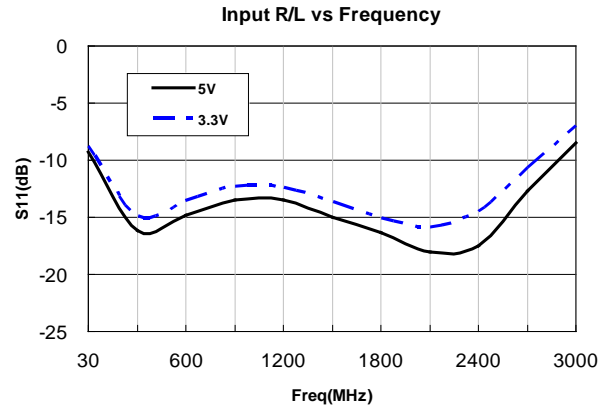
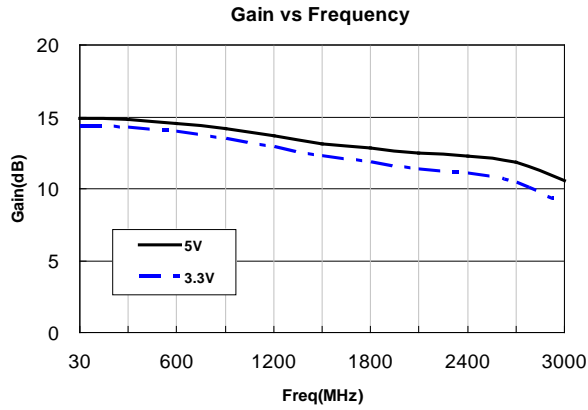



Typical Performance @ Voltage = 5V, 50ohm System (Temperature)

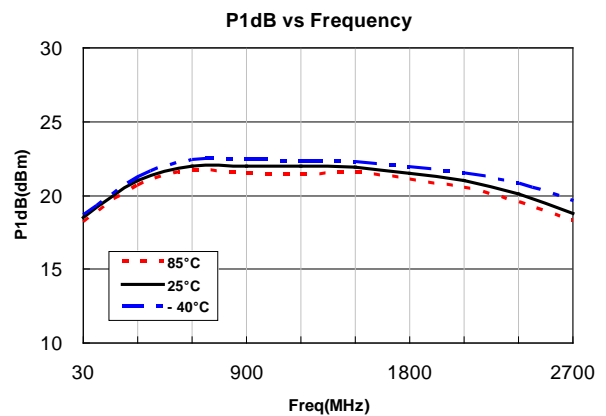
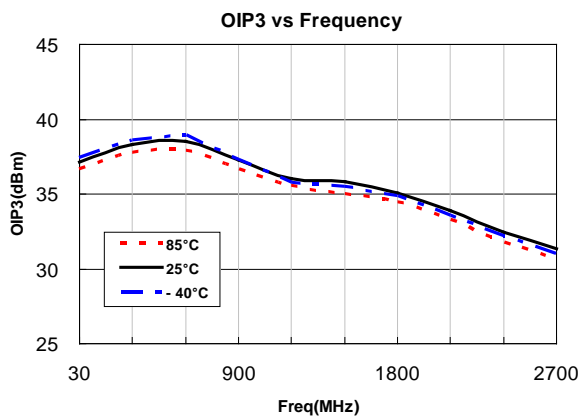
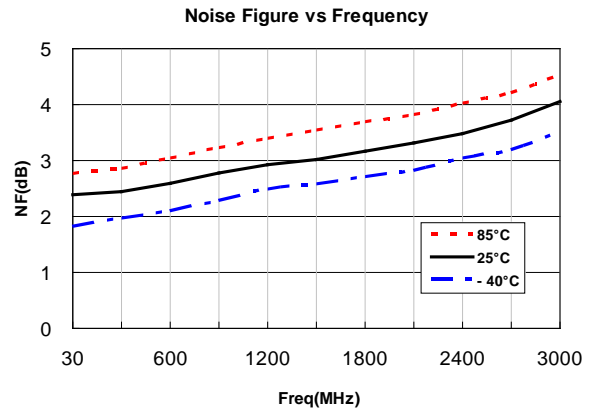
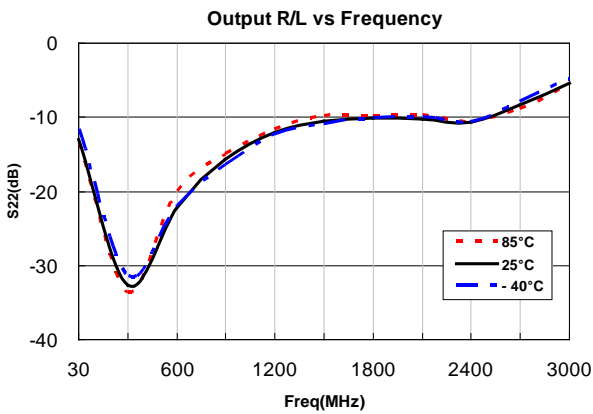
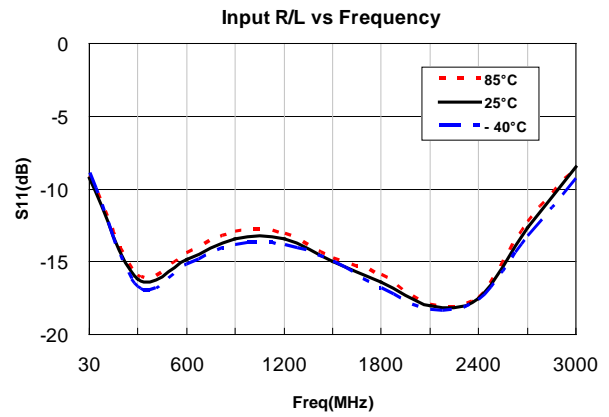
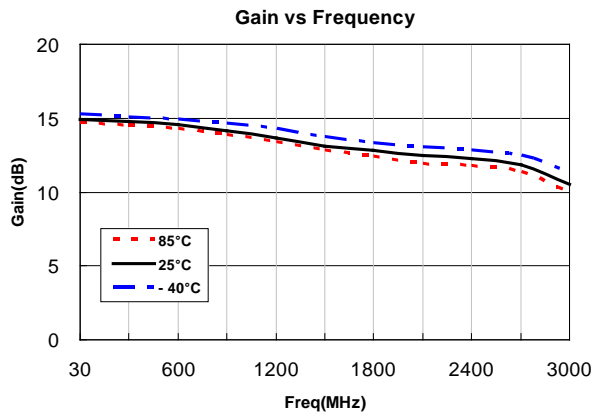

Package Dimensions (Type: SOT-89)

\* Unit: mm[inch] | Tolerance ±0.2[.008]

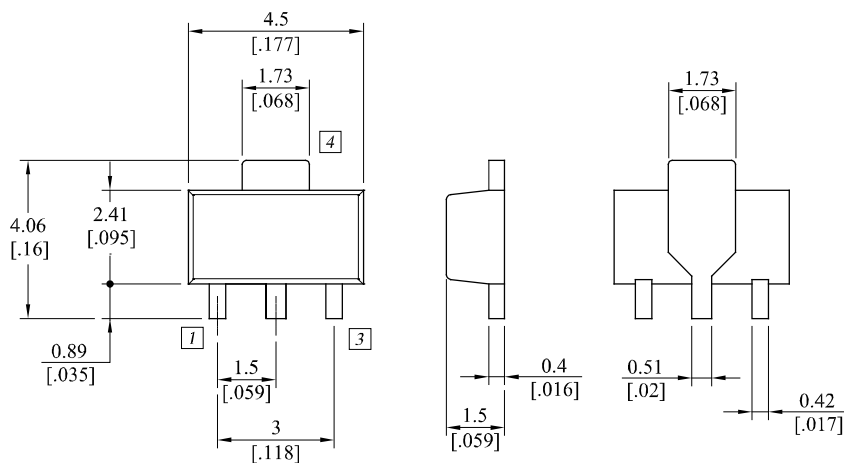

▲ Top View                      ▲ Side View                      ▲ Bottom View

Pin Description			
Pin No	Function	Pin No	Function
1	Input	4	GND
2	GND		-
3	Output / Bias		-

Recommended Pattern

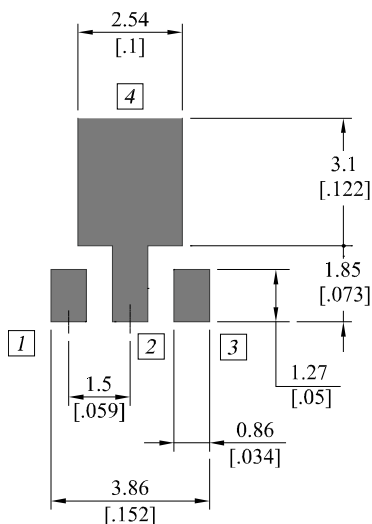

Recommended Mounting Configuration

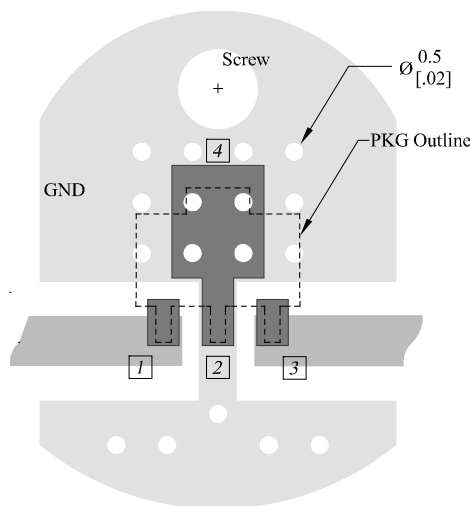

\* Mounting Configuration Notes

1. Ground / thermal via holes are critical for the proper performance of this device.
2. Add as much copper as possible to inner and outer layers near the part to ensure optimal thermal performance.
3. Mounting screws can be added near the part to fasten the board to a heatsink. Ensure that the ground / thermal via hole region contacts the heatsink.
4. Do not put solder mask on the backside of the PCB in the region where the board contacts the heatsink.
5. RF trace width depends upon the PCB material and construction.
6. Use 1 oz. Copper minimum.

**Revision History**

Part Number	Release Date	Version	Modification	Data Sheet Status
AE305	2014.4.11	1.3	Revision : Absolute Maximum Ratings	-
AE305	2012.10.17	1.2	New datasheet format	-
AE305	2012.5.8	1.1	Added test data of application of 3.3V supply voltage	-
AE305	2012.3.2	1.0	Initial Release.	-

RFHIC Corporation reserves the right to make changes to any products herein or to discontinue any product at any time without notice. While product specifications have been thoroughly examined for reliability, RFHIC Corporation strongly recommends buyers to verify that the information they are using is accurate before ordering. RFHIC Corporation does not assume any liability for the suitability of its products for any particular purpose, and disclaims any and all liability, including without limitation consequential or incidental damages. RFHIC products are not intended for use in life support equipment or application where malfunction of the product can be expected to result in personal injury or death. Buyer uses or sells such products for any such unintended or unauthorized application, buyer shall indemnify, protect and hold RFHIC Corporation and its directors, officers, stockholders, employees, representatives and distributors harmless against any and all claims arising out of such unauthorized use.

Sales, inquiries and support should be directed to the local authorized geographic distributor for RFHIC Corporation. For customers in the US, please contact the US Sales Team at 919-677-8780. For all other inquiries, please contact the International Sales Team at 82-31-250-5078