

Analog Devices Welcomes Hittite Microwave Corporation

NO CONTENT ON THE ATTACHED DOCUMENT HAS CHANGED



THIS PAGE INTENTIONALLY LEFT BLANK



Typical Applications

The HMC-C043 is ideal for:

- Point-to-Point Radios
- Point-to-Multi-Point Radios & VSAT
- Test Equipment & Sensors
- Military End-Use

Functional Diagram

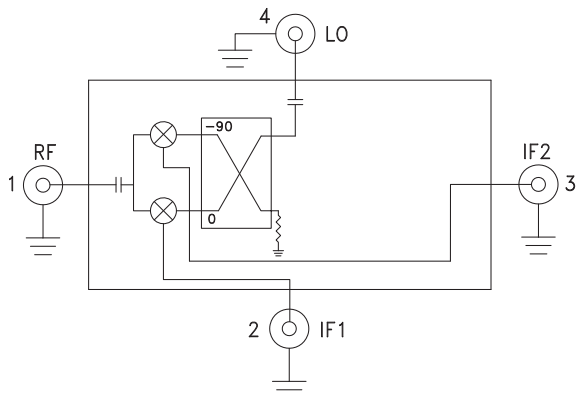

Features

- Wide IF Bandwidth: DC - 3.5 GHz
- Image Rejection: 30 dB
- LO to RF Isolation: 35 dB
- High Input IP3: +28 dBm
- Hermetically Sealed Module
- Field Replaceable SMA Connectors
- 55 °C to +85 °C Operating Temperature

General Description

The HMC-C043 is a passive I/Q MMIC mixer housed in a miniature hermetic module which can be used as either an Image Reject Mixer or a Single Sideband Upconverter. The module utilizes two standard Hittite double balanced mixer cells and a 90 degree hybrid fabricated on a GaAs MESFET process. A low frequency quadrature hybrid was used to produce a 100 MHz USB IF output. This MMIC based module is a more reliable and consistent alternative to hybrid style I/Q Mixers and Single Sideband Converter assemblies. The module features removable SMA connectors which can be detached to allow direct connection of the I/O pins to a microstrip or coplanar circuit.

Electrical Specifications, $T_A = +25^\circ\text{C}$, $IF = 100\text{ MHz}$, $LO = +19\text{ dBm}^*$

Parameter	Min.	Typ.	Max.	Units
Frequency Range, RF/LO		11 - 16		GHz
Frequency Range, IF		DC - 3.5		GHz
Conversion Loss (As IRM)		9	12	dB
Image Rejection	15	30		dB
1 dB Compression (Input)		+20		dBm
LO to RF Isolation	30	35		dB
LO to IF Isolation	18	25		dB
IP3 (Input)		+28		dBm
Amplitude Balance		0.5		dB
Phase Balance		5		Deg

* Unless otherwise noted, all measurements performed as downconverter.



Data taken As IRM With External IF Hybrid

Conversion Gain vs. Temperature

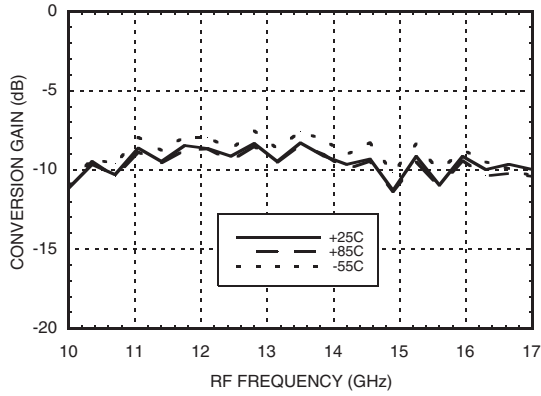

HMC-C043
GaAs MMIC I/Q MIXER MODULE
11 - 16 GHz

Image Rejection vs. Temperature

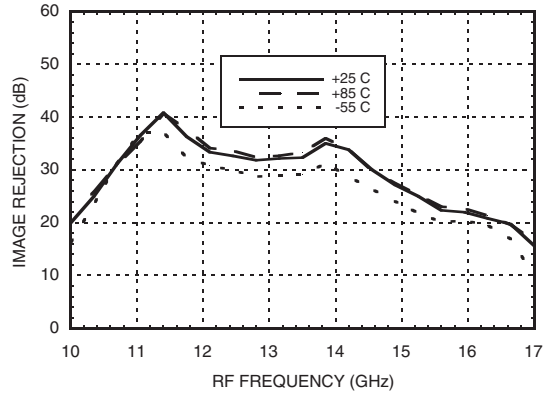

Conversion Gain vs. LO Drive

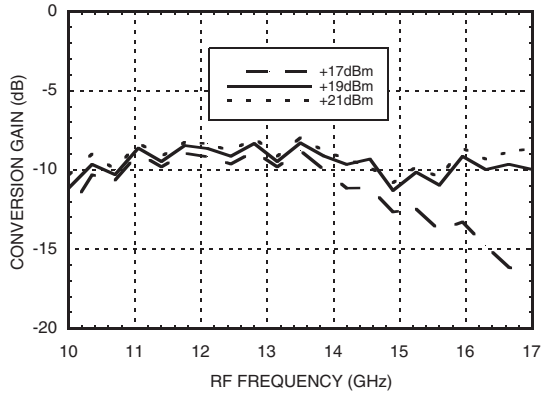

Return Loss

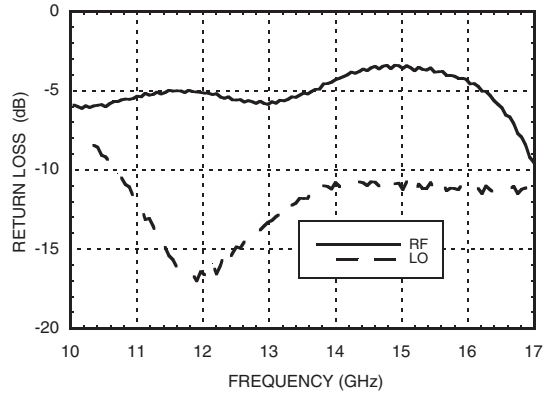

Input P1dB vs. Temperature

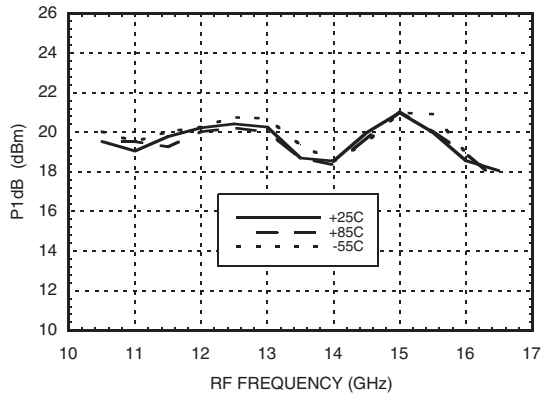

Input IP3 vs. LO Drive

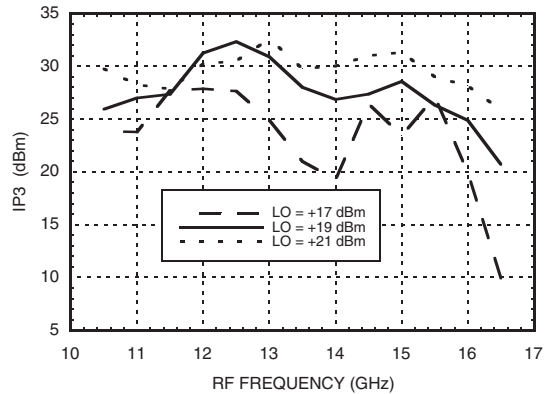



Quadrature Channel Data Taken Without IF Hybrid

Isolations

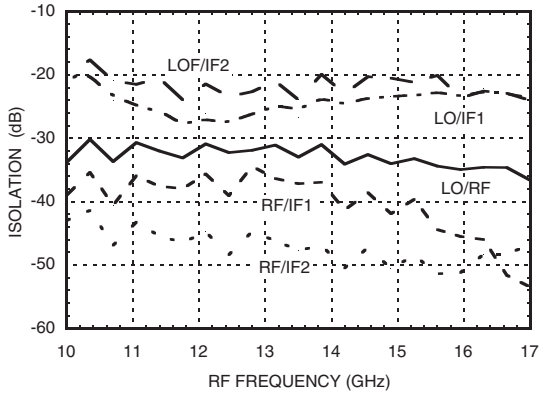

IF Bandwidth*

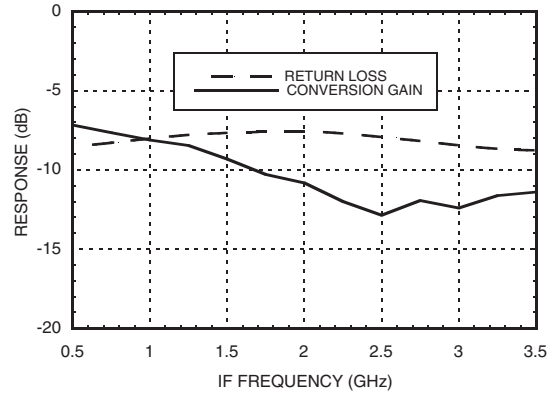

Amplitude Balance vs. LO Drive

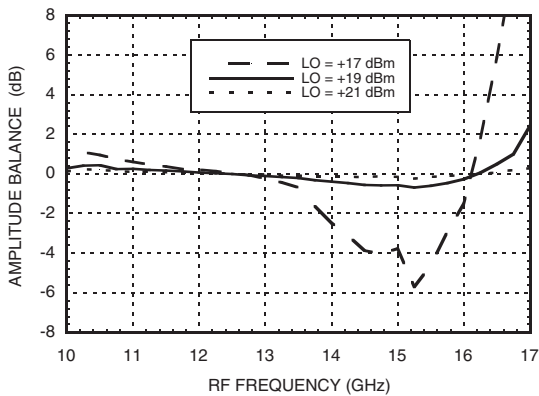

Phase Balance vs. LO Drive

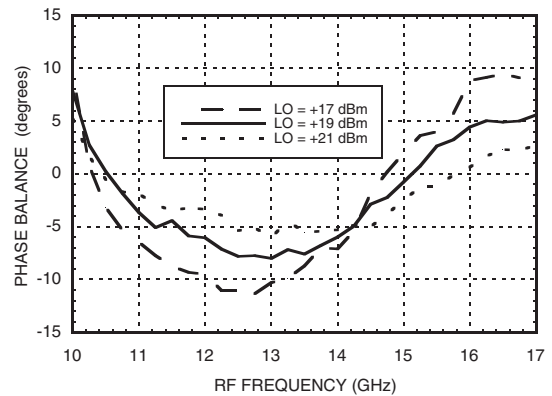

Upconverter Performance Conversion Gain vs. LO Drive*

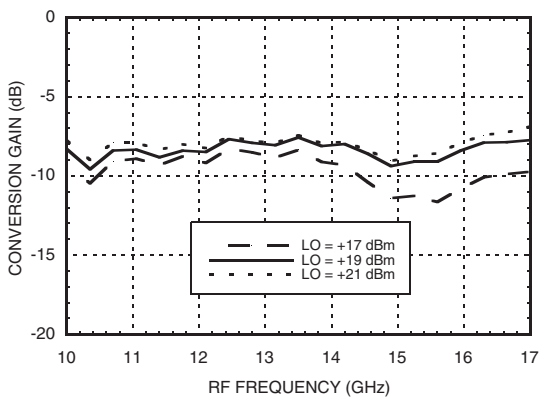

Upconverter Performance Sideband Rejection vs. LO Drive*

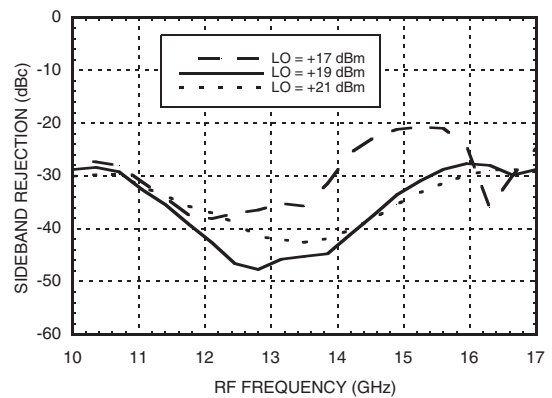

* Conversion gain data taken with external IF hybrid

Harmonics of LO

LO Freq. (GHz)	nLO Spur at RF Port			
	1	2	3	4
10.5	32	49	58	79
11.5	32	47	61	61
12.5	32	51	63	53
13.5	34	52	67	xx
14.5	35	48	69	xx
15.5	34	54	71	xx

LO = +19 dBm
Values in dBc below input LO level measured at RF Port.

MxN Spurious Outputs

mRF	nLO				
	0	1	2	3	4
0	xx	-12	7	14	xx
1	24	0	51	59	70
2	79	73	74	79	91
3	87	102	99	86	97
4	xx	84	102	97	105

RF = 13.6 GHz @ -10 dBm
LO = 13.5 GHz @ +19 dBm
Data taken without IF hybrid
All values in dBc below IF power level

Absolute Maximum Ratings

RF / IF Input	+20 dBm
LO Drive	+27 dBm
Channel Temperature	150°C
Continuous Pdiss (T=85°C) (derate 6.9 mW/°C above 85°C)	448 mW
Thermal Resistance (R _{TH}) (junction to die bottom)	145 °C/W
Storage Temperature	-65 to +150 °C
Operating Temperature	-55 to +85 °C



**ELECTROSTATIC SENSITIVE DEVICE
OBSERVE HANDLING PRECAUTIONS**

Outline Drawing

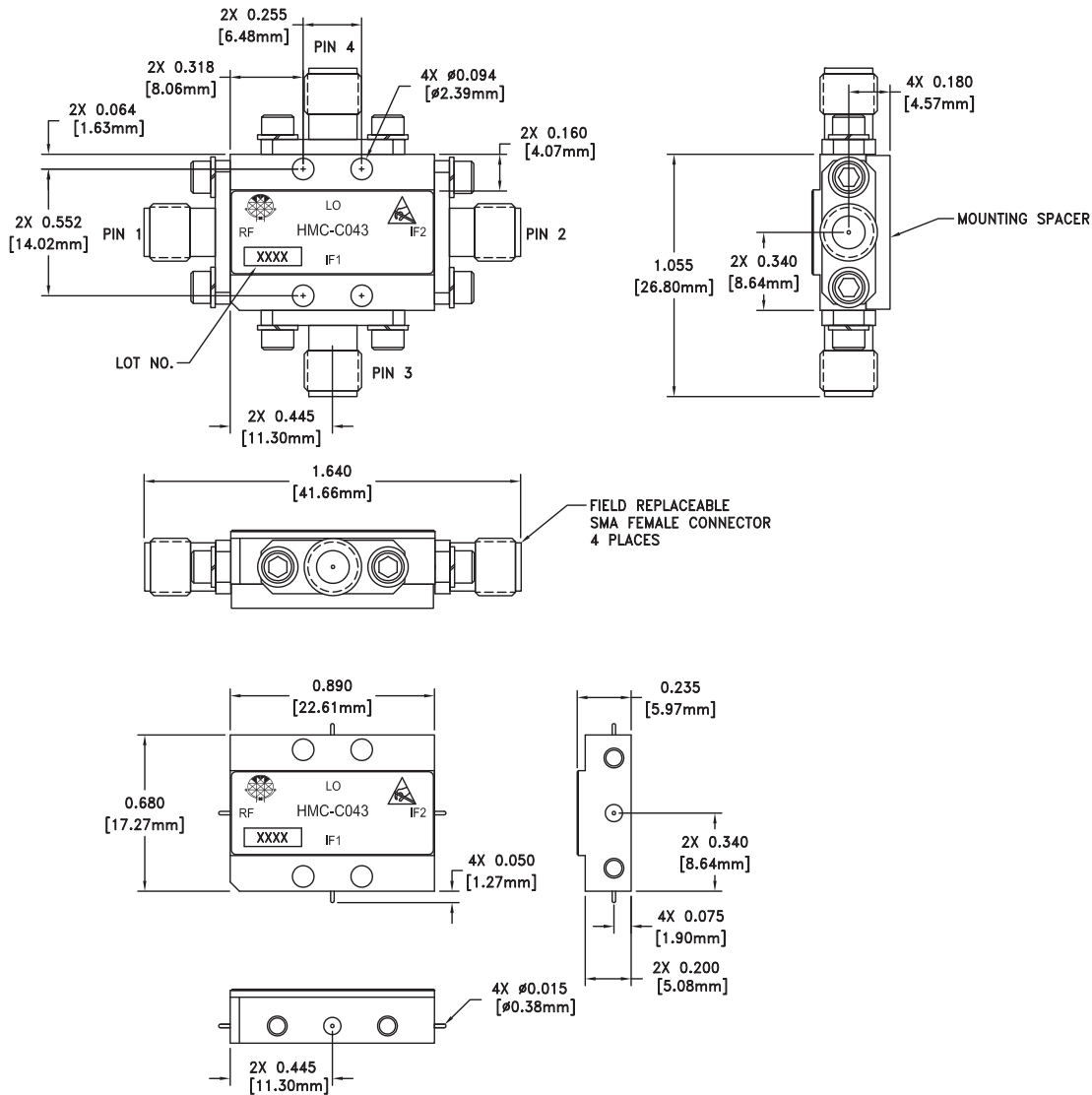

VIEW SHOWN WITH CONNECTORS REMOVED

Package Information

Package Type	C-4
Package Weight [1]	20 gms [2]
Spacer Weight	2.6 gms [2]

[1] Includes the connectors

[2] ±1 gms Tolerance

NOTES:

1. PACKAGE, LEADS, COVER MATERIAL: KOVAR™
2. FINISH: GOLD PLATE OVER NICKEL PLATE
3. MOUNTING SPACER: NICKEL PLATED ALUMINUM
4. ALL DIMENSIONS ARE IN INCHES [MILLIMETERS]
5. TOLERANCES:
 - 5.1 .XX = ±0.02
 - 5.2 .XXX = ±0.010
6. FIELD REPLACEABLE SMA CONNECTORS
TENSOLITE 5602 - 5CCSF OR EQUIVALENT
7. TO MOUNT MODULE TO SYSTEM PLATFORM REPLACE 0 -80
HARDWARE WITH DESIRED MOUNTING SCREWS

Pin Descriptions

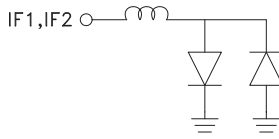
Pin Number	Function	Description	Interface Schematic
1	RF	This pin is AC coupled and matched to 50 Ohms.	
2	IF1	This pin is DC coupled. For applications not requiring operation to DC, this port should be DC blocked externally using a series capacitor whose value has been chosen to pass the necessary IF frequency range. For operation to DC, this pin must not source/sink more than 3 mA of current or part non-function and possible part failure will result.	
3	IF2		
4	LO	This pin is AC coupled and matched to 50 Ohms.	