

# 2.0-9.0 GHz GaAs MMIC Amplifier

## Features

- ✕ Wide Bandwidth
- ✕ 13 dB Typical Gain
- ✕ Small Size: 39x35 mils
- ✕ Directly Cascadable
- ✕ Self-Biased
- ✕ Single Power Supply

## General Description

Mimix Broadband's CMM-9 is a 2 to 9 GHz GaAs MMIC amplifier. It is a two-stage feedback design which provides high gain and good power from a single power supply. Applications include oscillator buffers, RF and IF gain blocks and driver amplifiers.

The CMM-9 is a very small chip which provides 13 dB of gain and 17 dBm of power from a 6 volt supply. The chip is directly cascadable with no additional components. The circuit's self-biasing feature provides excellent performance from a 5 to 7 volt supply. Care must be taken to isolate the input from the external DC voltages.

Mimix MMICs are fabricated on ion-implanted GaAs material with gold-based metalization. The FET gates are sub-half micron, tee cross-section construction. Air bridges are used for top level interconnection. Silicon nitride serves as capacitor dielectric and surface passivation. Mesa resistors are used for feedback and bias function.

The CMM-9 is available in chip form. It can be screened to meet commercial, military Hi-Rel or space grade reliability requirements. Custom wafer qualification for special electrical and/or reliability requirements is also available.

## Chip Diagram

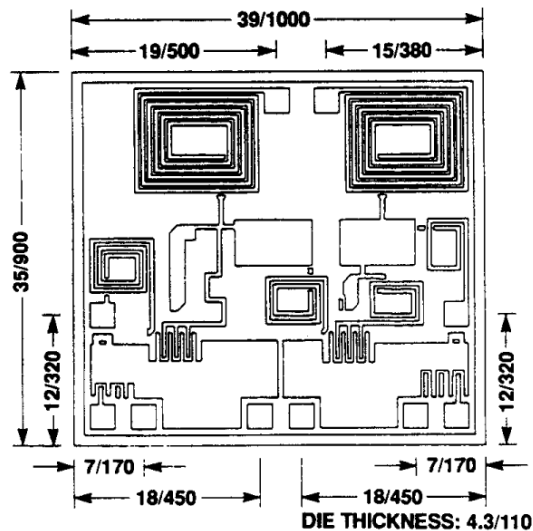

## Absolute Maximum Ratings

Voltage	8V
Continuous Power Dissipation	1.25 W
Channel Temperature	+175 °C
Storage Temperature	-65 to +175 °C
Mounting Temperature	+320 °C
Input Power	+20 dBm
$\theta_{JC}$	80 °C/W

# 2.0-9.0 GHz GaAs MMIC Amplifier

## Specifications ( $T_A = 25^\circ\text{C}, V_{DD} = 6\text{V}, 2\text{-}9\text{ GHz}$ )

Parameters	Units	Min	Typ	Max
Small Signal Gain	dB	11.5	13.0	
Gain Flatness	±dB		1.5	2.0
Input VSWR	—		1.8:1	2.0:1
Output VSWR	—		1.8:1	2.0:1
Reverse Isolation	dB	25	30	
Gain Variation Over Temperature (-55 to +95°C)	±dB		1.2	1.5
Noise Figure	dB		5.5	6.5
1 dB Gain Compression Power Output	dBm	15	17	
Current	mA		80	120

## Bonding Diagram

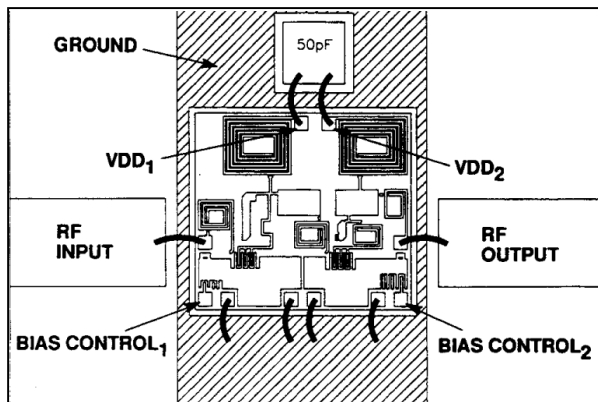

# 2.0-9.0 GHz GaAs MMIC Amplifier

## Typical Performance ( $T_A = 25^\circ\text{C}$ )

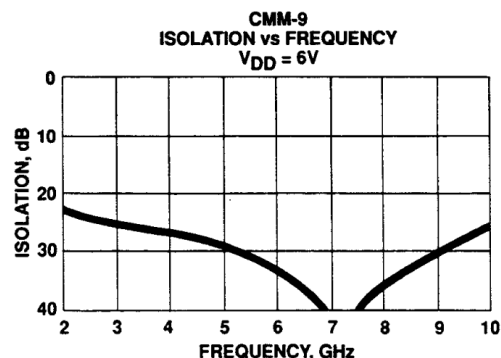
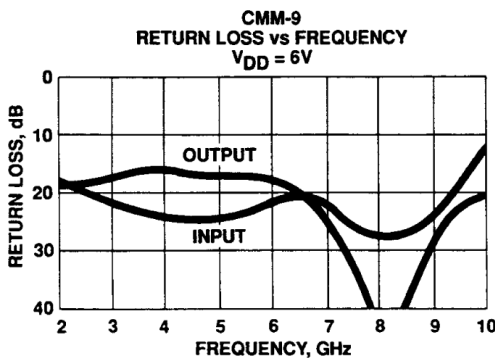
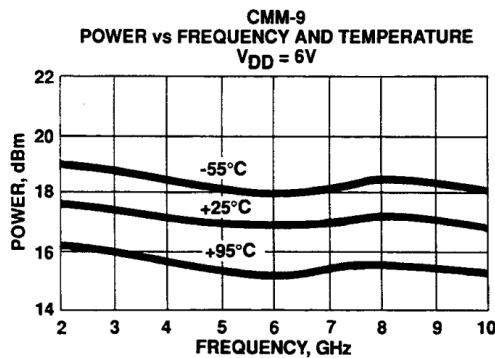
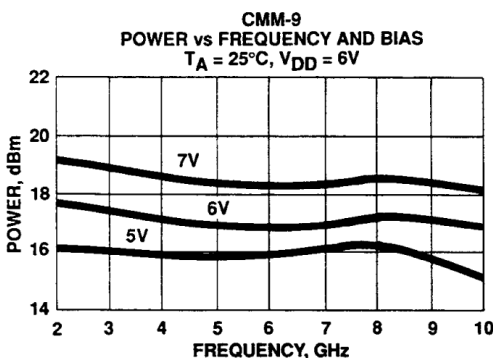
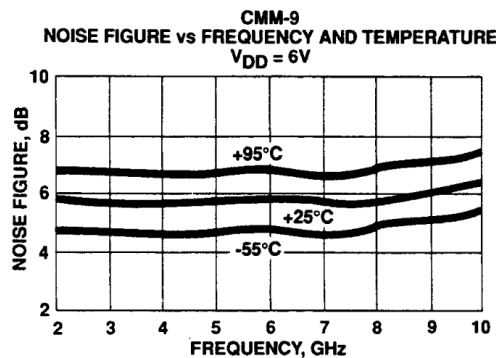
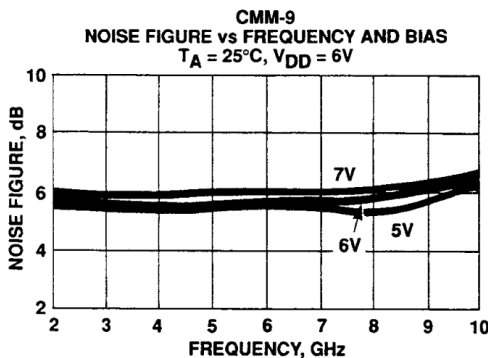
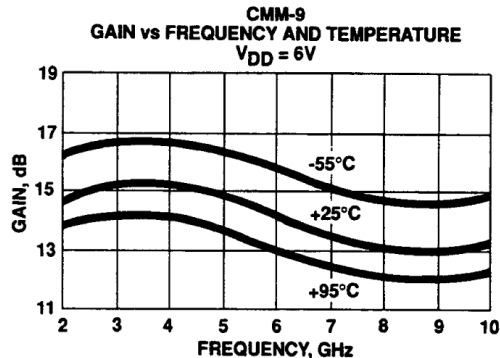
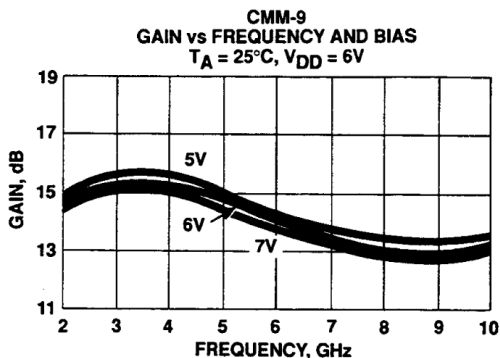

# 2.0-9.0 GHz GaAs MMIC Amplifier

## Typical Scattering Parameters, $T_A = 25^\circ\text{C}$ (S-Parameters Include Bonding Wire Parasitics)

CMM-9												$V_{DD} = 6\text{ V}$	
Frequency (GHz)	$S_{11}$		$S_{21}$			$S_{12}$			$S_{22}$				
	(dB)	(Mag) (Ang)	(dB)	(Mag) (Ang)	(dB)	(Mag) (Ang)	(dB)	(Mag) (Ang)	(dB)	(Mag) (Ang)			
2.0	-18.8	0.115 -113.94	14.8	5.505 -19.71	-33.8	0.020 38.50	-19.5	0.106 -87.88					
3.0	-22.0	0.079 -126.77	15.3	5.821 -71.15	-35.3	0.017 15.38	-18.0	0.126 -133.66					
4.0	-24.7	0.058 -135.91	15.2	5.754 -118.33	-36.9	0.014 6.02	-17.0	0.141 -174.54					
5.0	-26.2	0.049 -156.87	14.8	5.495 -161.63	-39.8	0.010 1.40	-17.7	0.130 148.74					
6.0	-21.2	0.087 166.67	14.1	5.070 158.96	-43.7	0.006 10.60	-18.6	0.117 139.19					
7.0	-22.7	0.073 151.20	13.4	4.677 122.26	-51.3	0.005 27.55	-24.7	0.058 116.68					
8.0	-27.3	0.043 116.76	13.0	4.467 87.16	-46.6	0.005 107.50	-44.4	0.006 112.43					
9.0	-24.3	0.061 6.11	13.0	4.467 51.62	-40.4	0.010 124.79	-27.9	0.040 -93.09					
10.0	-13.3	0.216 -32.75	13.3	4.624 12.23	-36.0	0.016 128.34	-20.4	0.095 -84.82					

### Equivalent Circuit

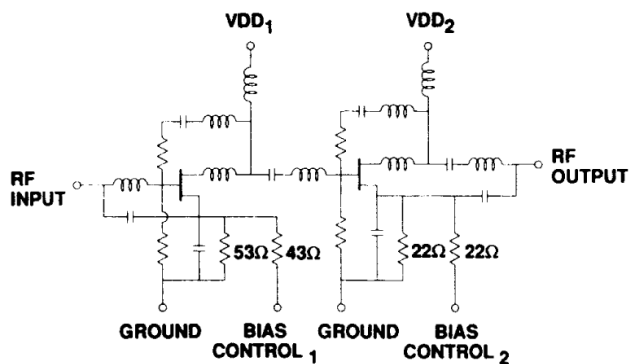

### Wafer Qualification Procedure

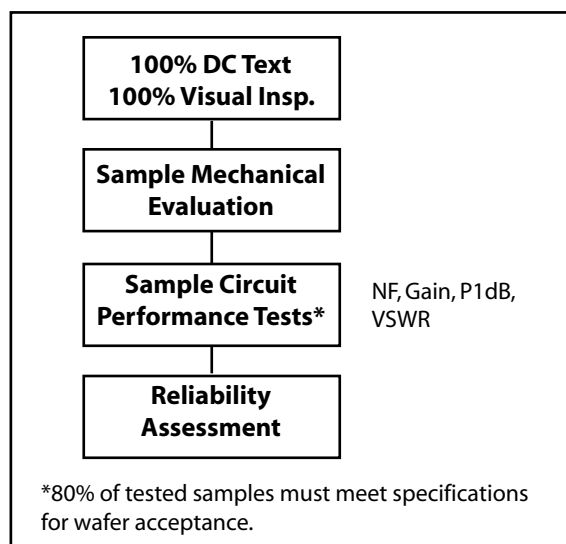

# 2.0-9.0 GHz GaAs MMIC Amplifier

## Handling and Assembly Information

**CAUTION!** - Mimix Broadband MMIC Products contain gallium arsenide (GaAs) which can be hazardous to the human body and the environment. For safety, observe the following procedures:

- *Do not ingest.*
- *Do not alter the form of this product into a gas, powder, or liquid through burning, crushing, or chemical processing as these by-products are dangerous to the human body if inhaled, ingested, or swallowed.*
- *Observe government laws and company regulations when discarding this product. This product must be discarded in accordance with methods specified by applicable hazardous waste procedures.*

**Life Support Policy** - Mimix Broadband's products are not authorized for use as critical components in life support devices or systems without the express written approval of the President and General Counsel of Mimix Broadband. As used herein: (1) Life support devices or systems are devices or systems which, (a) are intended for surgical implant into the body, or (b) support or sustain life, and whose failure to perform when properly used in accordance with instructions for use provided in the labeling, can be reasonably expected to result in a significant injury to the user. (2) A critical component is any component of a life support device or system whose failure to perform can be reasonably expected to cause the failure of the life support device or system, or to affect its safety or effectiveness.

**ESD** - Gallium Arsenide (GaAs) devices are susceptible to electrostatic and mechanical damage. Die are supplied in antistatic containers, which should be opened in cleanroom conditions at an appropriately grounded antistatic workstation. Devices need careful handling using correctly designed collets, vacuum pickups or, with care, sharp tweezers.

**Die Attach:** Conductive epoxy or preform die attach is recommended. For preform die attach: Preform: AuSn (80% Au, 20% Sn); Stage Temperature: 290 °C, +/-5 °C; Handling Tool: Tweezers; Time: 1 min or less.

**Wire Bonding:** Wire Size: 0.7 to 1.0 mil in diameter (pre-stressed); Thermocompression bonding is preferred over thermosonic bonding. For thermocompression bonding: Stage Temperature: 250 °C ; Bond Tip Temperature: 150 °C; Bonding Tip Pressure: 18 to 40 gms depending on size of wire.

**RoHS Compliant Parts** - All Mimix products are RoHS compliant unless otherwise specified.

## Ordering Information

### Part Number for Ordering

CMM-9-BD-000X

### Description

Where "X" is RoHS compliant die packed in "V" - vacuum release gel packs or "W" - waffle trays



Proper ESD procedures should be followed when handling this device.