

Features:

- Broad bandwidth, specification from 50~6000MHz, usable from 10MHz to 7GHz
- Low VSWR, unconditional stable
- Small size, low cost
- SMA female connector I/O
- Single DC power supply, internal voltage regulator, operating voltage from +9~+15V
- Operating temperature -40~+75°C, storage temperature -45~+125°C



Electrical Specifications

Parameters	Minimum	Typical	Maximum
Frequency Range	50 MHz		6000MHz
Noise Figure (from 50MHz)		4.0 dB	4.75 dB
P-1dB Compression Point @ 100MHz @ 3GHz @6GHz	+16dBm +15dBm +9dBm	+17 dBm +16dBm +10dBm	
Nominal SS Gain @25°C	24 dB	27dB	31 dB
Gain flatness		+/-2.0 dB	+/-2.5 dB
Gain Variation		+/-1.0 dB	
Input VSWR		1.3:1	1.5:1
Output VSWR		1.2:1	1.5:1
Reverse Isolation	37 dB	41dB	
Spurious			-60 dBc
Operating Temperature	-40°C		+75°C
Survival Temperature	-45°C		+125°C
DC Voltage	+9V	+12 V	+15 V
DC Supply Current	110 mA	130 mA	140 mA
In/Out connectors	SMA female		
Size	1.7"x0.95"x0.375		

Functional Diagram

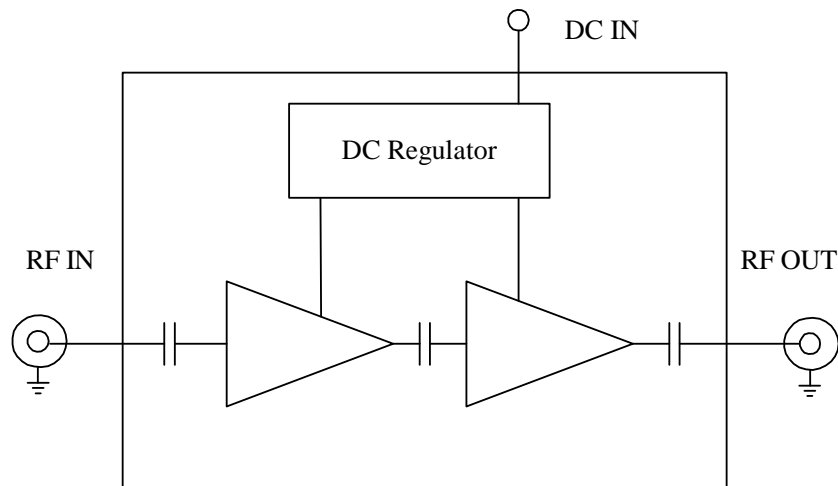

Mechanical Structure:

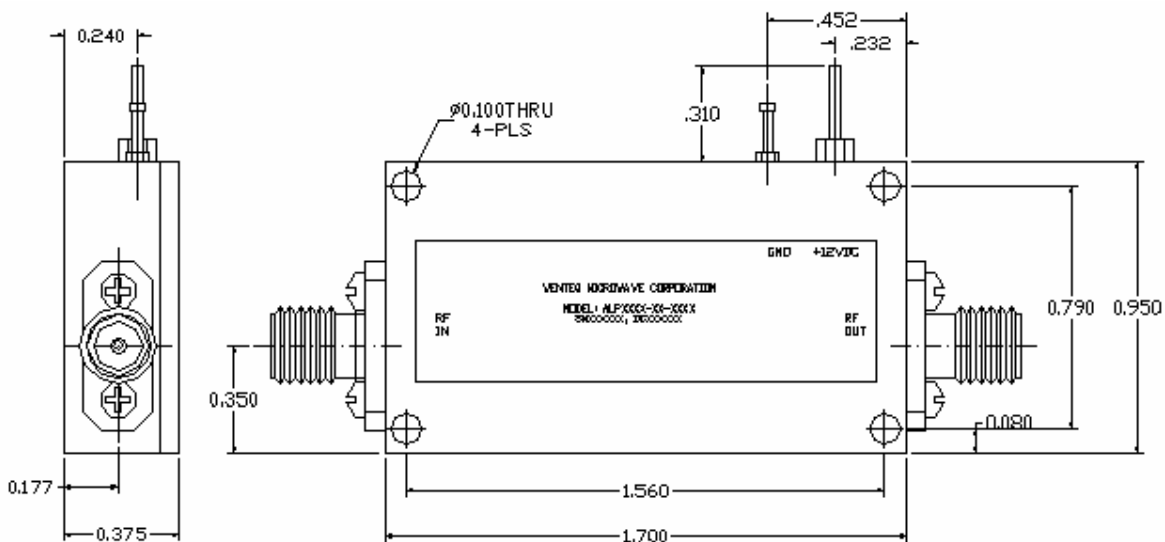

Note: All units in inches.

Typical Test Results:

ABL0600-01-2740 Measured Gain and Return Loss vs Frequency

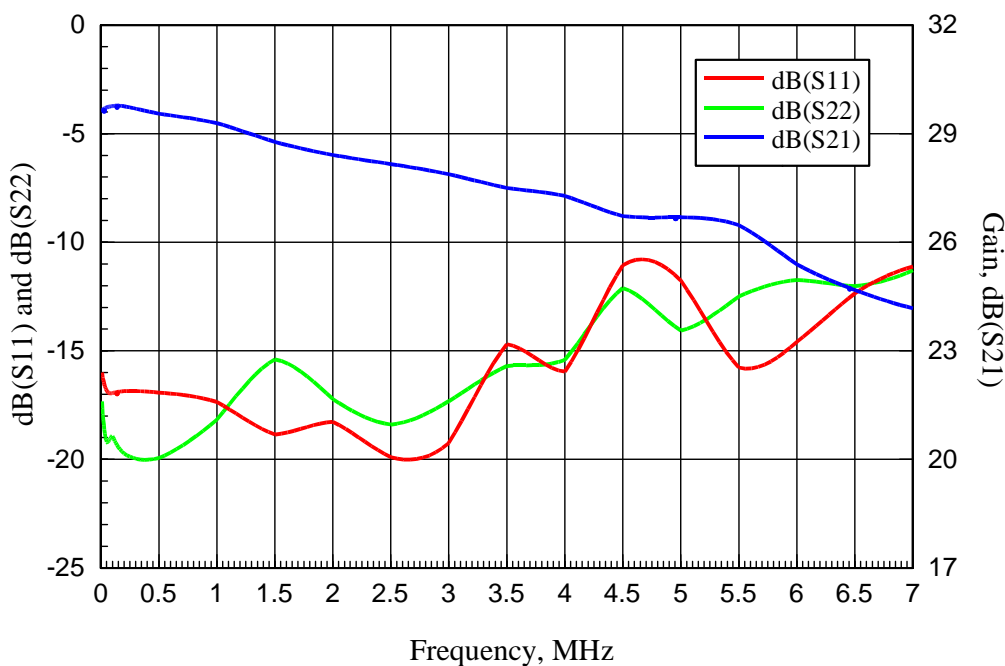

ABL0600-01-2740 Measured Noise Figure vs Frequency

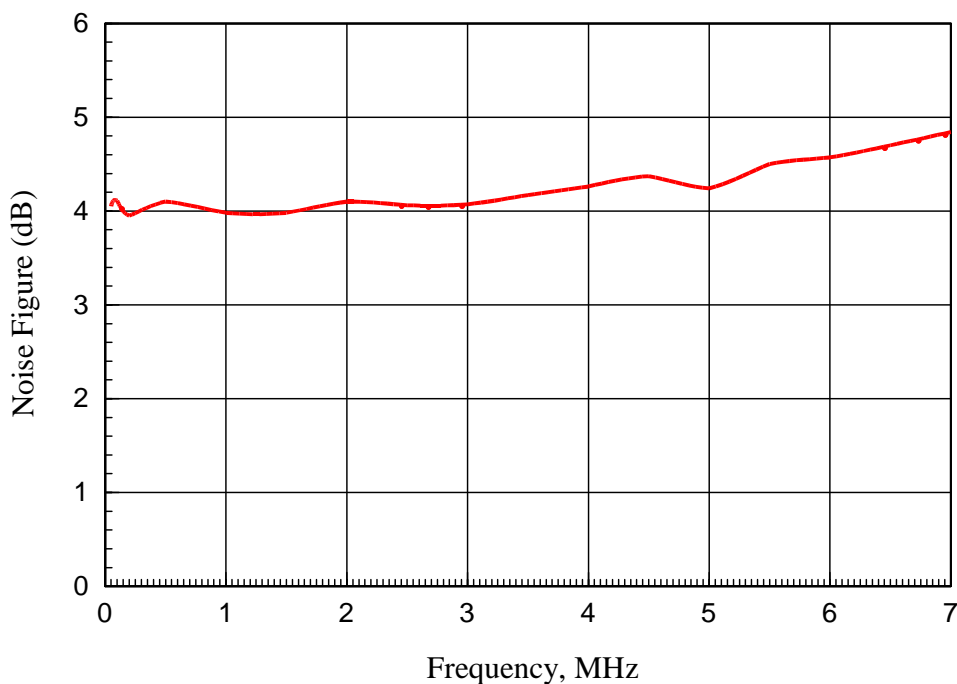

ABL0600-01-2740 Measured Gain and Output Power vs Input Power
Test Frequency: 100MHz

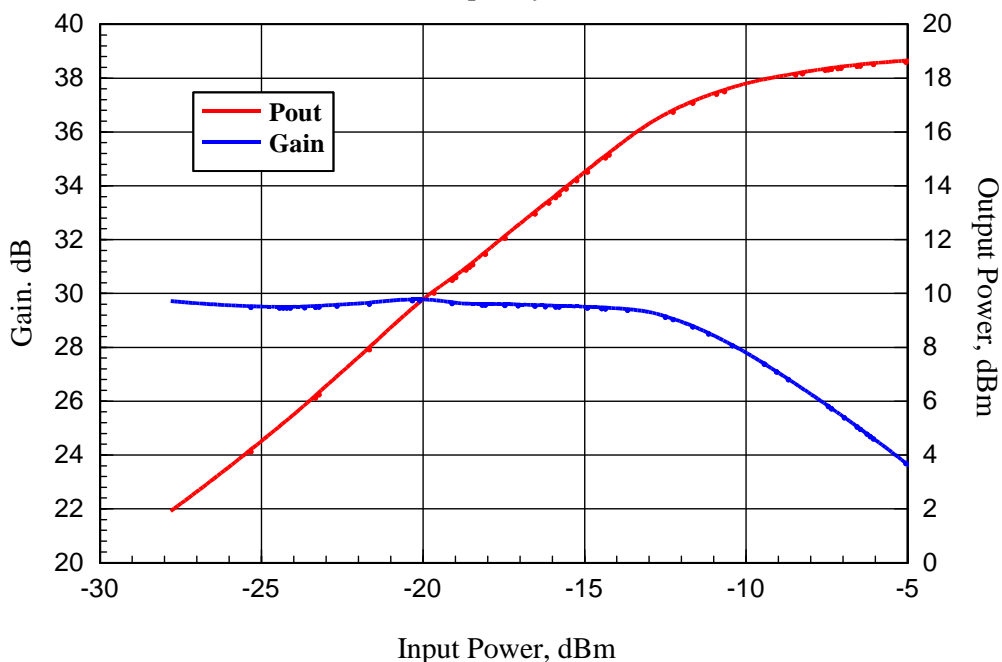

ABL0600-01-2740 Measured Gain and Output Power vs Input Power
Test Frequency: 3000MHz

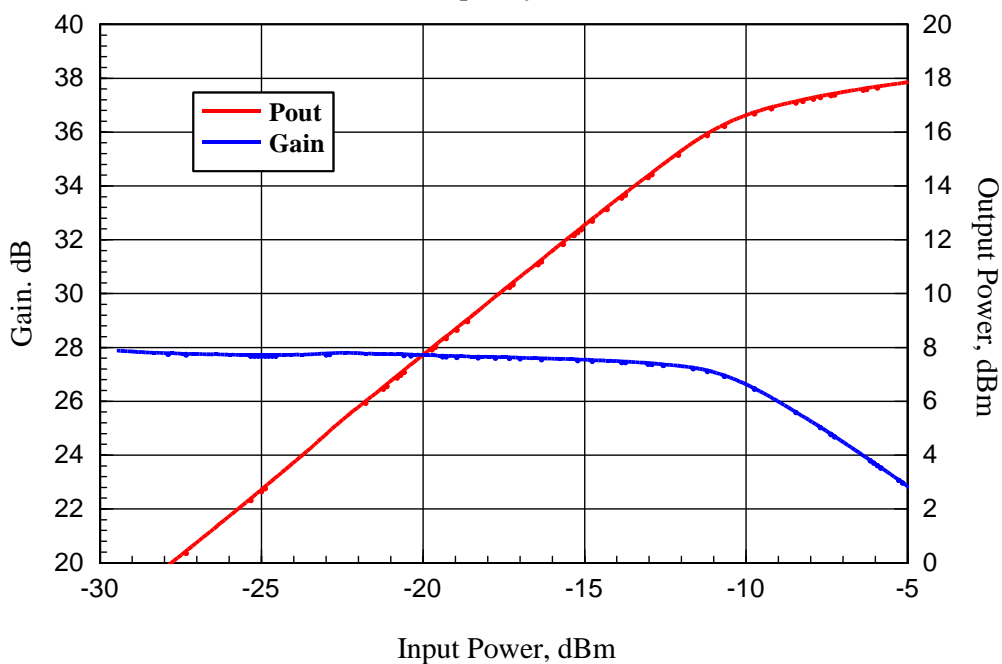

ABL0600-01-2740 Measured Gain and Output Power vs Input Power
Test Frequency: 6000MHz

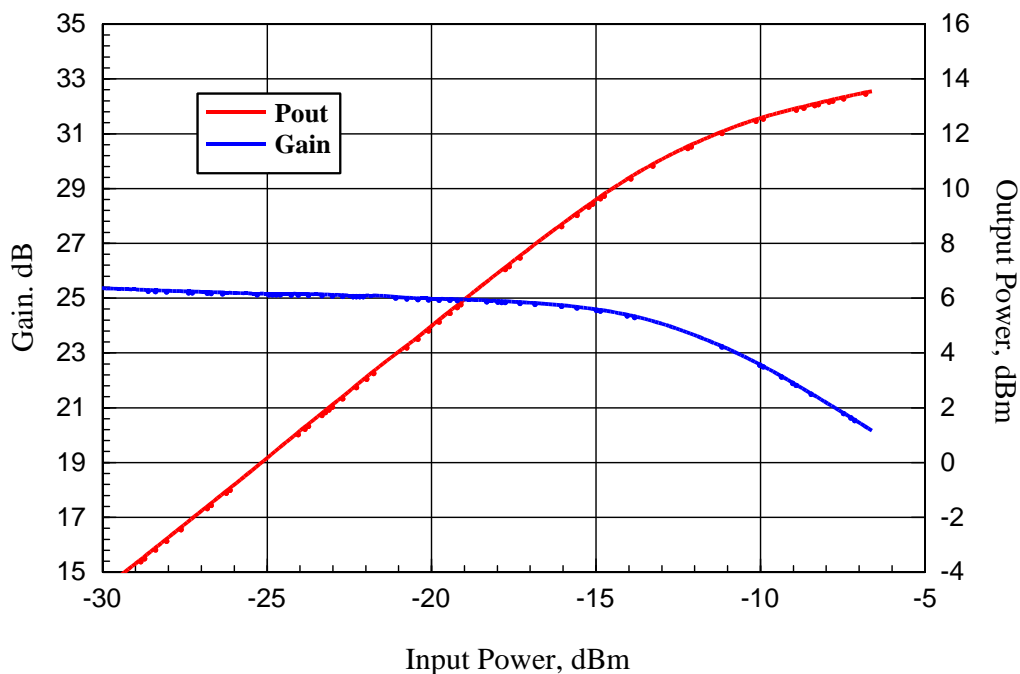

Absolute Maximum Ratings

DC Voltage	+15V
RF Input Power	+10 dBm
Storage Temperature	-55~+125°C
Operating Temperature	-40~+75°C