

Analog Devices Welcomes Hittite Microwave Corporation

NO CONTENT ON THE ATTACHED DOCUMENT HAS CHANGED



THIS PAGE INTENTIONALLY LEFT BLANK

Typical Applications

This HMC-SDD112 is ideal for:

- FCC E-Band Communication Systems
- Short-Haul / High Capacity Radios
- Automotive Radar
- Test & Measurement Equipment
- SATCOM
- Sensors

Features

- Low Insertion Loss: 2 dB
- High Isolation: 30 dB
- DC Blocked RF I/Os
- Integrated DC Bias Circuitry
- Die Size: 2.01 x 0.975 x 0.1 mm

Functional Diagram

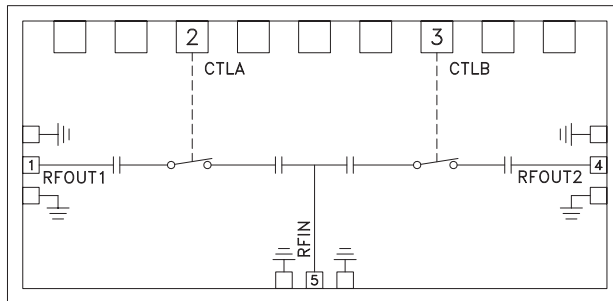

General Description

The HMC-SDD112 is a monolithic, GaAs PIN diode based Single Pole Double Throw (SPDT) MMIC Switch which exhibits low insertion loss and high isolation. This all-shunt MMIC SPDT features on-chip DC blocks and DC bias voltage decoupling circuitry. All bond pads and the die backside are Ti/Au metallized and the PIN diode devices are fully passivated for reliable operation. The HMC-SDD112 GaAs PIN SPDT is compatible with conventional die attach methods, as well as thermocompression and thermosonic wirebonding, making it ideal for MCM and hybrid microcircuit applications. All data shown herein is measured with the chip in a 50 Ohm environment and contacted with RF probes.

Electrical Specifications*, $T_A = +25\text{ }^\circ\text{C}$, with -5/+5V Control, 50 Ohm System

Parameter	Min.	Typ.	Max.	Units
Frequency Range	55 - 86			GHz
Insertion Loss		2	3	dB
Isolation	25	30		dB
Return Loss ON State		12		dB
Current (+5 V) ON State		22		mA
Current (-5 V) OFF State		-63		nA

* Unless otherwise indicated, all measurements are from probed die

**GaAs PIN MMIC SPDT SWITCH
55 - 86 GHz**

“On” Insertion Loss vs. Freq. CTLA= -5V, CTLB= 5V for RFOUT1 to be ON

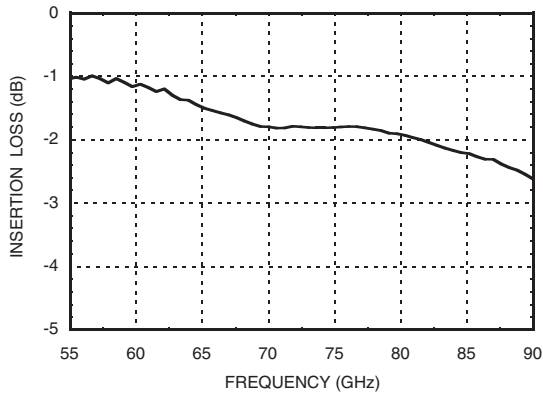

“Off” Isolation vs. Freq. CTLA= +5V, CTLB= -5V for RFOUT1 to be OFF

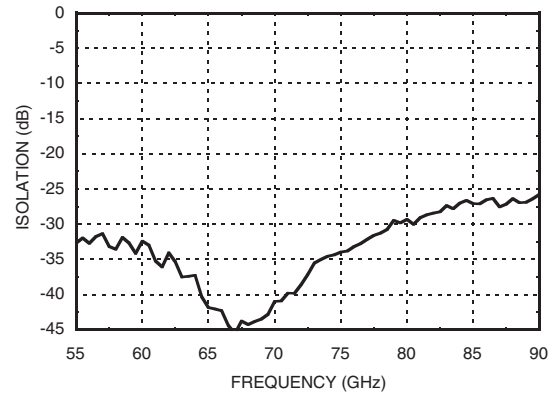

“On” Input Return Loss vs. Freq. CTLA= -5V, CTLB= 5V for RFOUT1 to be ON

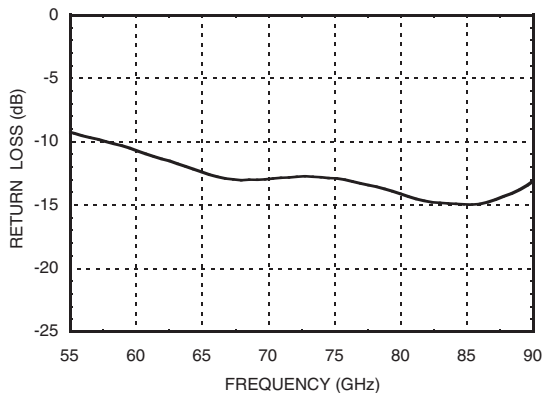

“On” Output Return Loss vs. Freq. CTLA= -5V, CTLB= 5V for RFOUT1 to be ON

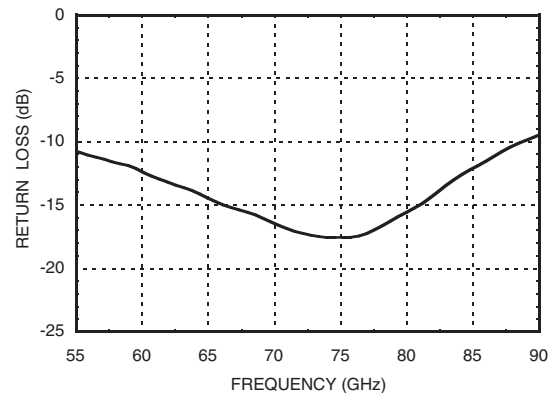

Note 1: Measured Performance Characteristics (Typical Performance at 25°C) Test data is taken with probes on RFIN and RFOUT1 with RFOUT2 left open.

For price, delivery, and to place orders, please contact Hittite Microwave Corporation:
20 Alpha Road, Chelmsford, MA 01824 Phone: 978-250-3343 Fax: 978-250-3373
Order On-line at www.hittite.com

Absolute Maximum Ratings

Bias Voltage Range	-5.5 to 5.5 Vdc
Storage Temperature	-65 to +150 °C
Operating Temperature	-55 to +85 °C
Bias Current (ON State)	30 mA



**ELECTROSTATIC SENSITIVE DEVICE
OBSERVE HANDLING PRECAUTIONS**

Control Voltages

State	Bias Condition
Low	-5 V @ 63 nA typical
High	+5 V @ 22 mA typical

Truth Table

Control Input		Signal Path State	
CTLA	CTLB	RFIN to RFOUT1	RFIN to RFOUT2
Low (-5V)	High (+5V)	On	Off
High (+5V)	Low (-5V)	Off	On

Outline Drawing

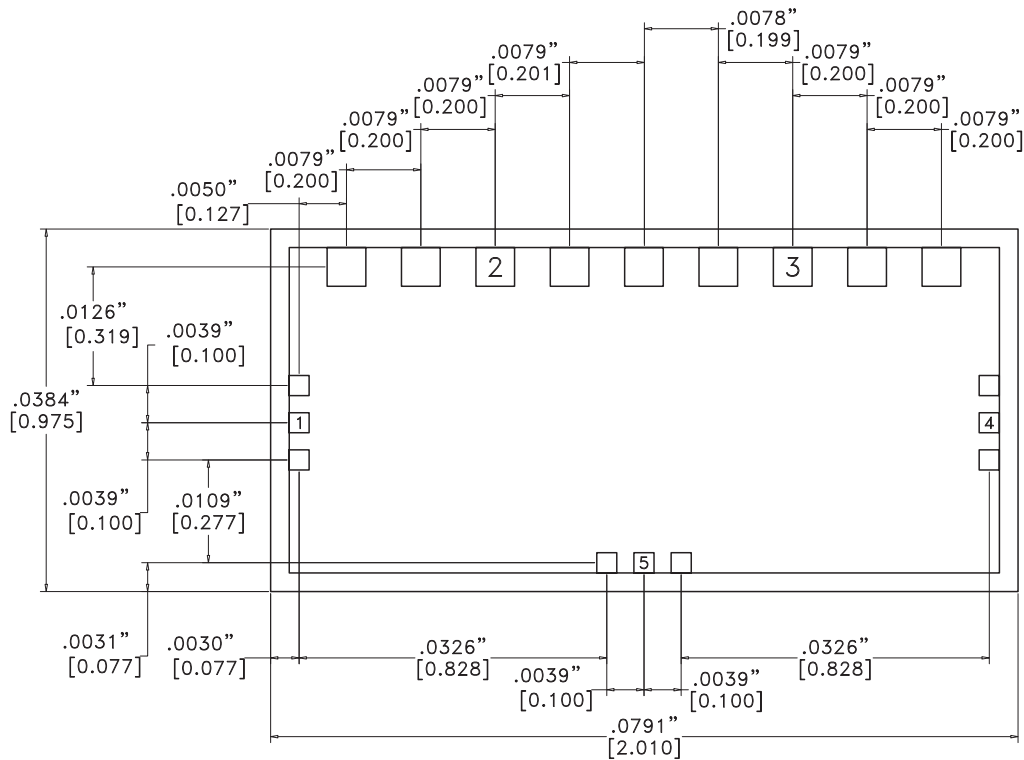

Die Packaging Information ^[1]

Standard	Alternate
GP-5 (Gel Pack)	[2]



[1] Refer to the "Packaging Information" section for die packaging dimensions.

[2] For alternate packaging information contact Hittite Microwave Corporation.

NOTES:

- ALL DIMENSIONS ARE IN INCHES [MM].
- TYPICAL BOND PAD IS .004" SQUARE.
- BACKSIDE METALLIZATION: GOLD.
- BACKSIDE METAL IS GROUND.
- BOND PAD METALLIZATION: GOLD.
- CONNECTION NOT REQUIRED FOR UNLABELED BOND PADS.
- OVERALL DIE SIZE ±.002"

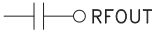
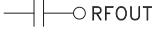
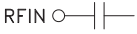
Pad Descriptions

Pad Number	Function	Pin Description	Interface Schematic
1	RFOUT1	This pin is DC blocked and matched to 50 Ohms.	
2,3	CTLA, CTLB	See Truth Table and Control Voltage Table	
4	RFOUT2	This pin is DC blocked and matched to 50 Ohms.	
5	RFIN	This pin is DC blocked and matched to 50 Ohms.	
Die Bottom	GND	Die bottom must be connected to RF/DC ground.	

Assembly Diagram

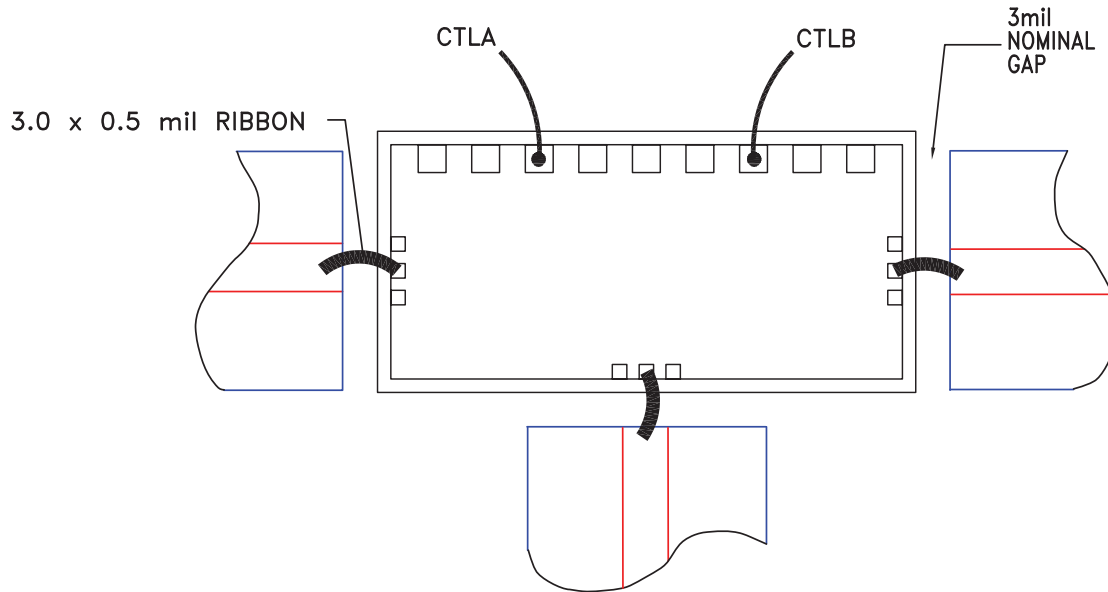

Note 1: Bypass caps should be 100 pF (approximately) ceramic (single-layer) placed no farther than 30 mils from the switch.

Note 2: Best performance obtained from use of <6 mil (long) by 1.5 by 0.5 mil ribbons on input and output.

Mounting & Bonding Techniques for Millimeterwave GaAs MMICs

The die should be attached directly to the ground plane eutectically or with conductive epoxy (see HMC general Handling, Mounting, Bonding Note).

50 Ohm Microstrip transmission lines on 0.127mm (5 mil) thick alumina thin film substrates are recommended for bringing RF to and from the chip (Figure 1). If 0.254mm (10 mil) thick alumina thin film substrates must be used, the die should be raised 0.150mm (6 mils) so that the surface of the die is coplanar with the surface of the substrate. One way to accomplish this is to attach the 0.102mm (4 mil) thick die to a 0.150mm (6 mil) thick molybdenum heat spreader (moly-tab) which is then attached to the ground plane (Figure 2).

Microstrip substrates should be brought as close to the die as possible in order to minimize bond wire length. Typical die-to-substrate spacing is 0.076mm to 0.152 mm (3 to 6 mils).

Handling Precautions

Follow these precautions to avoid permanent damage.

Storage: All bare die are placed in either Waffle or Gel based ESD protective containers, and then sealed in an ESD protective bag for shipment. Once the sealed ESD protective bag has been opened, all die should be stored in a dry nitrogen environment.

Cleanliness: Handle the chips in a clean environment. DO NOT attempt to clean the chip using liquid cleaning systems.

Static Sensitivity: Follow ESD precautions to protect against ESD strikes.

Transients: Suppress instrument and bias supply transients while bias is applied. Use shielded signal and bias cables to minimize inductive pick-up.

General Handling: Handle the chip along the edges with a vacuum collet or with a sharp pair of bent tweezers. The surface of the chip has fragile air bridges and should not be touched with vacuum collet, tweezers, or fingers.

Mounting

The chip is back-metallized and can be die mounted with AuSn eutectic preforms or with electrically conductive epoxy. The mounting surface should be clean and flat.

Eutectic Die Attach: A 80/20 gold tin preform is recommended with a work surface temperature of 255 °C and a tool temperature of 265 °C. When hot 90/10 nitrogen/hydrogen gas is applied, tool tip temperature should be 290 °C. DO NOT expose the chip to a temperature greater than 320 °C for more than 20 seconds. No more than 3 seconds of scrubbing should be required for attachment.

Epoxy Die Attach: Apply a minimum amount of epoxy to the mounting surface so that a thin epoxy fillet is observed around the perimeter of the chip once it is placed into position. Cure epoxy per the manufacturer's schedule.

Wire Bonding

Ball or wedge bond with 0.025mm (1 mil) diameter pure gold wire. Thermosonic wirebonding with a nominal stage temperature of 150 °C and a ball bonding force of 40 to 50 grams or wedge bonding force of 18 to 22 grams is recommended. Use the minimum level of ultrasonic energy to achieve reliable wirebonds. Wirebonds should be started on the chip and terminated on the package or substrate. All bonds should be as short as possible <0.31mm (12 mils).

