

**VI TELEFILTER**

**Filter specification**

**TFS 456P**

**1/5**

**Measurement condition**

Ambient temperature:	23	°C
Input power level:	0	dBm
Terminating impedance: *		
Input:	540 Ω	-3,6 pF
Output:	680 Ω	-3,8 pF

**Characteristics**

**Remark:**

The reference level for the relative attenuation  $a_{rel}$  of the TFS 456P is the minimum of the pass band attenuation. This value is defined as the insertion loss  $a_e$ . The nominal frequency  $f_N$  is fixed at 456,0 MHz without any tolerance. The values of relative attenuation  $a_{rel}$  are guaranteed for the whole operating temperature range. The frequency shift of the filter in the operating temperature range is included in the production tolerance scheme.

<b>D a t a</b>		<b>typ. value</b>		<b>tolerance / limit</b>	
<b>Insertion loss</b> (reference level)	$a_e$	8,0	dB	max.	10,0 dB
<b>Nominal frequency</b>	$f_N$	-			456,0 MHz
<b>Centre frequency</b>	$f_c$	456,0	MHz		-
<b>Passband</b>	PB	-		$f_N \pm$	0,79 MHz
<b>Pass band ripple</b>		0,3	dB	max.	1,0 dB
<b>Bandwidth</b>	BW				
1 dB		1,81	MHz	min.	1,58 MHz
<b>Relative attenuation</b>	$a_{rel}$				
$f_N \pm 1,75$ MHz ... $f_N \pm 2$ MHz		39	dB	min.	35 dB
$f_N \pm 2$ MHz ... $f_N \pm 20$ MHz		45	dB	min.	40 dB
$f_N \pm 20$ MHz ... $f_N \pm 192$ MHz		54	dB	min.	50 dB
<b>Group delay ripple within <math>f_N \pm 0,6</math> MHz</b>		120	ns	max.	250 ns
<b>Group delay ripple within PB</b>		320	ns	max.	500 ns
<b>Return loss within PB</b>		14	dB	min.	10 dB
<b>Input power level</b>		-		max.	15 dBm
<b>Operating temperature range</b>	OTR	-			- 40 °C ... + 85°C
<b>Storage temperature range</b>		-			- 45 °C ... + 85°C
<b>Frequency inversion temperature</b>		16	°C		
<b>Temperature coefficient of frequency</b>	$TC_f$ **	- 0,04	ppm/K <sup>2</sup>		

\*) The terminating impedances depend on parasitics and q-values of matching elements and the board used, and are to be understood as reference values only. Should there be additional questions do not hesitate to ask for an application note or contact our design team.

\*\*)  $\Delta f(\text{Hz}) = TC_f(\text{ppm/K}^2) \times (T-T_0)^2 \times f_{cat}(\text{MHz})$ .

**Generated:**

---

**Checked / Approved:**

---

**Tele Filter GmbH**  
**Potsdamer Straße 18**  
**D 14 513 TELTOW / Germany**  
**Tel: (+49) 3328 4784-0 / Fax: (+49) 3328 4784-30**  
**E-Mail: [tft@telefilter.com](mailto:tft@telefilter.com)**

VI TELEFILTER reserves the right to make changes to the product(s) and/or information contained herein without notice. No liability is assumed as a result of their use or application. No rights under any patent accompany the sale of any such product(s) or information.

**Filter characteristic**

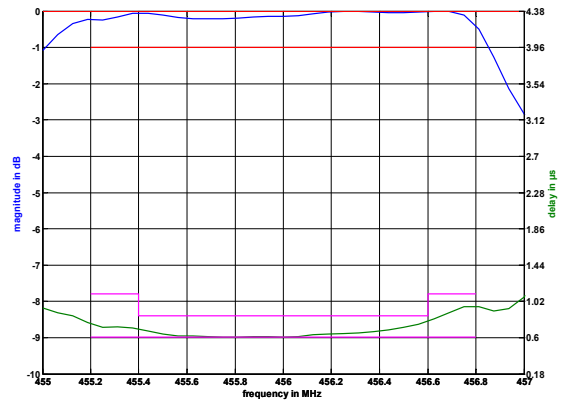
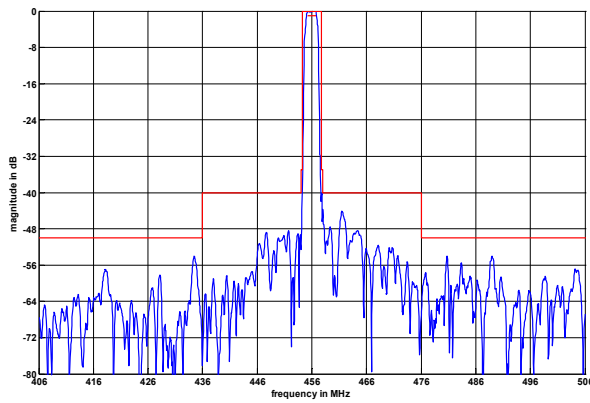

**Construction and pin connection**

(All dimensions in mm)

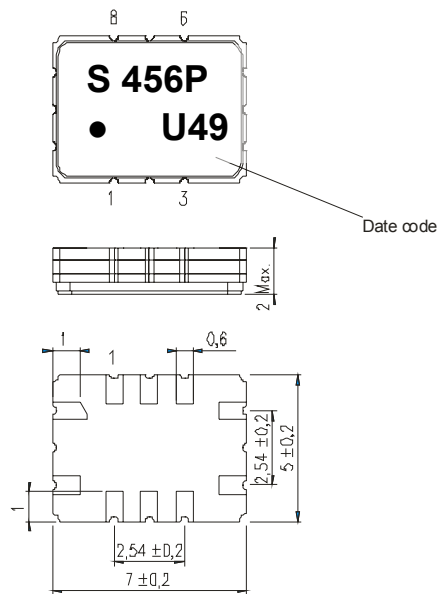

- 1 Ground
- 2 Ground
- 3 Ground
- 4 Output
- 5 Output RF Return
- 6 Ground
- 7 Ground
- 8 Ground
- 9 Input
- 10 Input RF Return

Date code: Year + week  
 U 2006  
 V 2007  
 W 2008  
 ...

**50 Ω Test circuit**

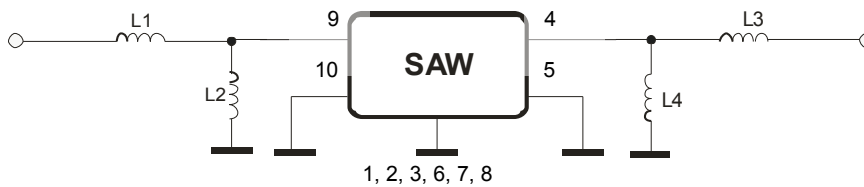

**Tele Filter GmbH**  
 Potsdamer Straße 18  
 D 14 513 TELTOW / Germany  
 Tel: (+49) 3328 4784-0 / Fax: (+49) 3328 4784-30  
 E-Mail: [tft@telefilter.com](mailto:tft@telefilter.com)

VI TELEFILTER reserves the right to make changes to the product(s) and/or information contained herein without notice. No liability is assumed as a result of their use or application. No rights under any patent accompany the sale of any such product(s) or information.

**Stability characteristics, reliability**

After the following tests the filter shall meet the whole specification:

1. Shock: 500g, 1 ms, half sine wave, 3 shocks each plane;  
DIN IEC 68 T2 - 27
2. Vibration: 10 Hz to 500 Hz, 0,35 mm or 5 g respectively, 1 octave per min, 10 cycles per plan, 3 plans;  
DIN IEC 68 T2 - 6
3. Change of temperature: -55 °C to 125°C / 30 min. each / 10 cycles  
DIN IEC 68 part 2 – 14 Test N
4. Resistance to solder heat (reflow): reflow possible: three times max.;  
for temperature conditions refer to the attached "Air reflow temperature conditions" on page 4;

This filter is RoHS compliant (2002/95/EG, 2005/618/EG)

**Packing**

Tape & Reel: IEC 286 – 3, with exception of value for N and minimum bending radius;  
tape type II, embossed carrier tape with top cover tape on the upper side;

max. pieces of filters per reel:	3000
reel of empty components at start:	min. 300 mm
reel of empty components at start including leader:	min. 500 mm
trailer:	min. 300 mm

**Tape (all dimensions in mm)**

- W : 16,00 ± 0,3
- Po : 4,00 ± 0,1
- Do : 1,50 +0,1/-0
- E : 1,75 ± 0,1
- F : 7,50 ± 0,1
- G(min) : 0,60
- P2 : 2,00 ± 0,1
- P1 : 8,00 ± 0,1
- D1(min) : 1,50
- Ao : 5,50 ± 0,1
- Bo : 7,50 ± 0,1
- Ct : 13,5 ± 0,1

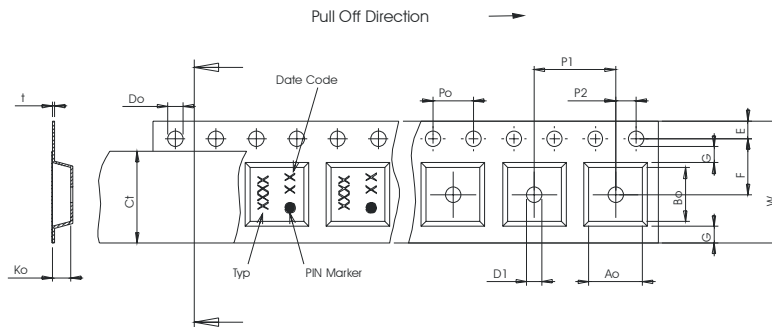

**Reel (all dimensions in mm)**

- A : 330
- W1 : 16,4 +2/-0
- W2(max) : 22,4
- N(min) : 50
- C : 13,0 +0,5/-0,2

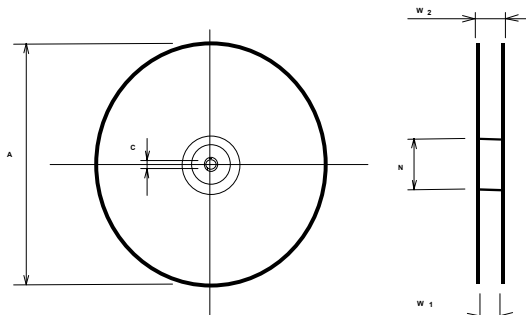

The minimum bending radius is 45 mm.

**Tele Filter GmbH**  
**Potsdamer Straße 18**  
**D 14 513 TELTOW / Germany**  
**Tel: (+49) 3328 4784-0 / Fax: (+49) 3328 4784-30**  
**E-Mail: [tft@telefilter.com](mailto:tft@telefilter.com)**

VI TELEFILTER reserves the right to make changes to the product(s) and/or information contained herein without notice. No liability is assumed as a result of their use or application. No rights under any patent accompany the sale of any such product(s) or information.

**Air reflow temperature conditions**

Conditions	Exposure
Average ramp-up rate (30°C to 217°C)	less than 3°C/second
> 100°C	between 300 and 600 seconds
> 150°C	between 240 and 500 seconds
> 217°C	between 30 and 150 seconds
Peak temperature	max. 260°C
Time within 5°C of actual peak temperature	between 10 and 30 seconds
Cool-down rate (Peak to 50°C)	less than 6°C/second
Time from 30°C to Peak temperature	no greater than 300 seconds

**Chip-mount air reflow profile**

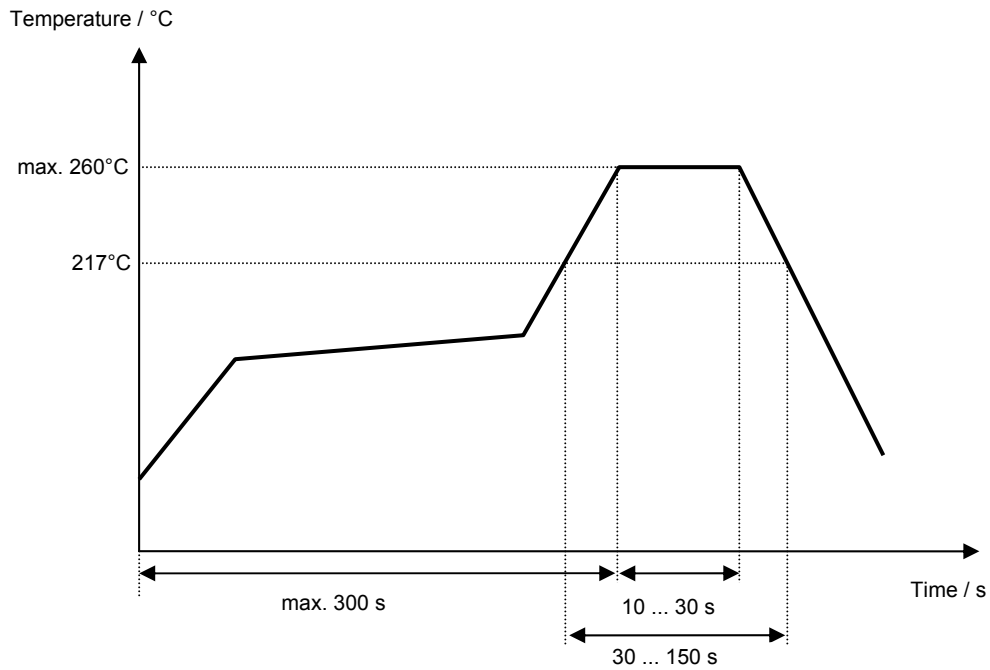

Tele Filter GmbH  
 Potsdamer Straße 18  
 D 14 513 TELTOW / Germany  
 Tel: (+49) 3328 4784-0 / Fax: (+49) 3328 4784-30  
 E-Mail: [tft@telefilter.com](mailto:tft@telefilter.com)

VI TELEFILTER reserves the right to make changes to the product(s) and/or information contained herein without notice. No liability is assumed as a result of their use or application. No rights under any patent accompany the sale of any such product(s) or information.

**VI TELEFILTER****Filter specification****TFS 456P****5/5****History**

<b>Version</b>	<b>Reason of Changes</b>	<b>Name</b>	<b>Date</b>
1.0	- Generation of development specification	Strehl	18.11.2005
1.1	- Correct data, pin connection and stability characteristics	Strehl	13.12.2005
1.2	- Change pin connection	Strehl	21.12.2005
1.3	- terminating impedance, typical values, filter characteristic and matching configuration added - pass band frequency range changed	Pfeiffer	29.03.2006
1.4	- Add input power level	Strehl	08.12.2006

---

**Tele Filter GmbH**  
**Potsdamer Straße 18**  
**D 14 513 TELTOW / Germany**  
**Tel: (+49) 3328 4784-0 / Fax: (+49) 3328 4784-30**  
**E-Mail: [tft@telefilter.com](mailto:tft@telefilter.com)**

VI TELEFILTER reserves the right to make changes to the product(s) and/or information contained herein without notice. No liability is assumed as a result of their use or application. No rights under any patent accompany the sale of any such product(s) or information.