



GaAs MMIC SMT PASSIVE FREQUENCY DOUBLER, 1.3 - 4.0 GHz INPUT

Typical Applications

The HMC158C8 is suitable for:

- Wireless Local Loop
- LMDS, VSAT, and Point-to-Point Radios
- UNII & HiperLAN
- Test Equipment

Features

- Conversion Loss: 15 dB
- Fo, 3Fo, 4Fo Isolation: 40 dB
- Input Drive Level: 10 to 20 dBm

Functional Diagram

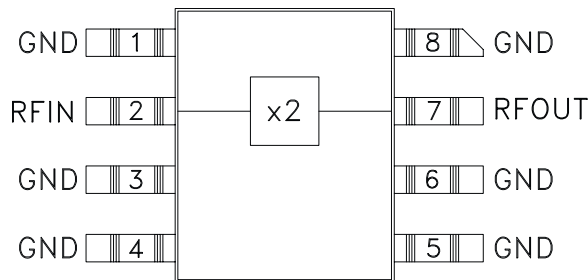

General Description

The HMC158C8 is a miniature frequency doubler MMIC in a non-hermetic ceramic surface mount non-hermetic package. Suppression of undesired fundamental and higher order harmonics is 40 dB typical with respect to input signal level. The doubler uses the same diode/balun technology used in Hittite MMIC mixers, features small size and requires no DC bias.

Electrical Specifications, $T_A = +25^\circ \text{C}$, As a Function of Drive Level

Parameter	Input = +10 dBm			Input = +15 dBm			Input = +20 dBm			Units
	Min.	Typ.	Max.	Min.	Typ.	Max.	Min.	Typ.	Max.	
Frequency Range, Input	1.7 - 4.0			1.7 - 3.5			1.3 - 4.0			GHz
Frequency Range, Output	3.4 - 8.0			3.4 - 7.0			2.6 - 8.0			GHz
Conversion Loss		18	22		15	18		15	18	dB
FO Isolation (with respect to input level)				37	45					dB
3FO Isolation (with respect to input level)				40	50					dB
4FO Isolation (with respect to input level)				32	40					dB



GaAs MMIC SMT PASSIVE FREQUENCY DOUBLER, 1.3 - 4.0 GHz INPUT

Conversion Gain vs. Drive Level

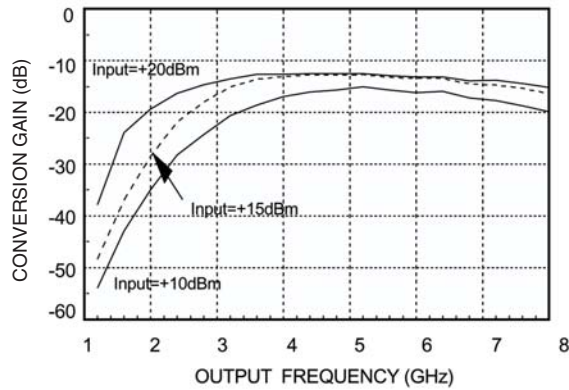

Isolation @ +15 dBm Drive Level*

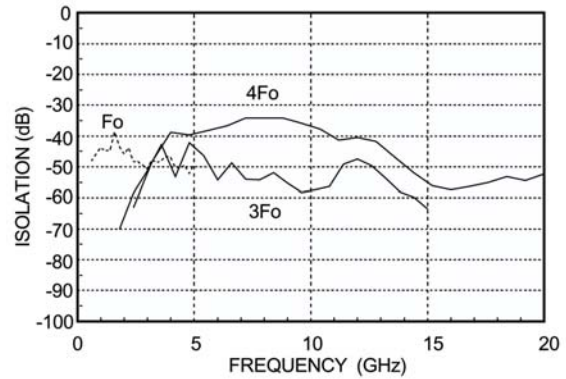

*With respect to input level

Input Return Loss vs. Drive Level

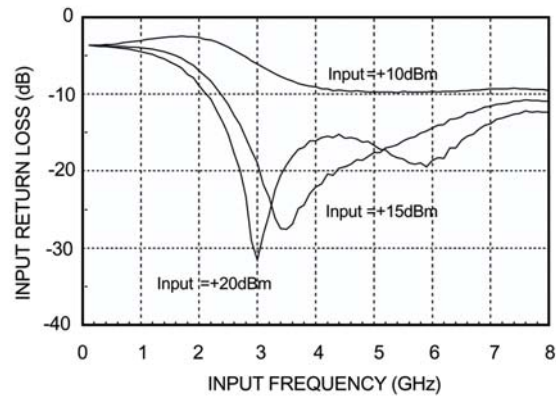

Output Return Loss vs. Drive Level

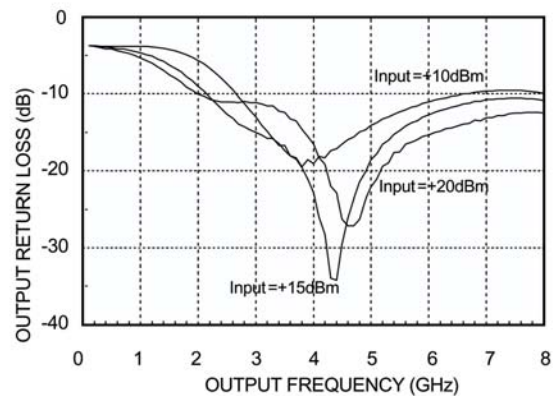



GaAs MMIC SMT PASSIVE FREQUENCY DOUBLER, 1.3 - 4.0 GHz INPUT

Absolute Maximum Ratings

Input Drive	+27 dBm
Storage Temperature	-65 to +150 °C
Operating Temperature	-40 to +85 °C
ESD Sensitivity (HBM)	Class 1A



ELECTROSTATIC SENSITIVE DEVICE
OBSERVE HANDLING PRECAUTIONS

Outline Drawing

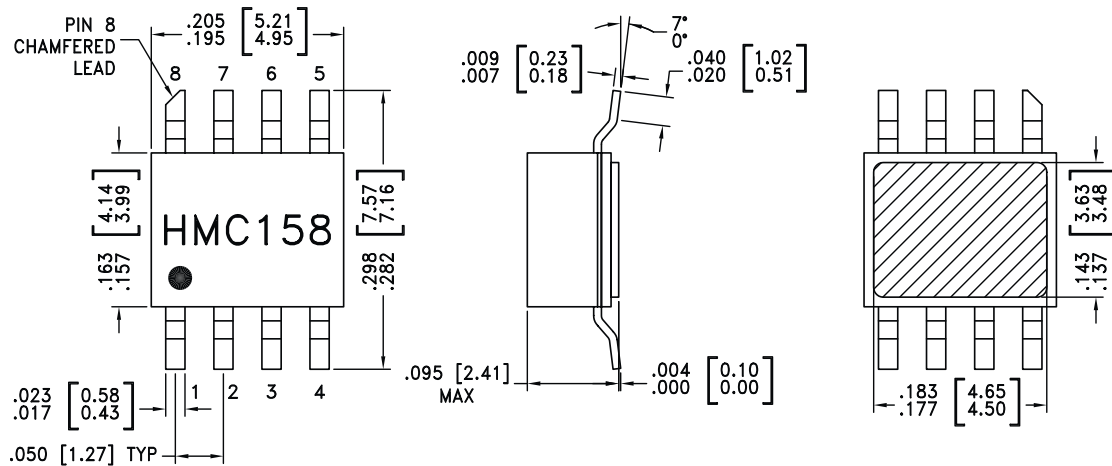

NOTES:

1. PACKAGE BODY MATERIAL: WHITE ALUMINA 92%
2. LEAD, PACKAGE BOTTOM MATERIAL: COPPER
3. PLATING: ELECTROLYTIC GOLD 100 - 200 MICROINCHES OVER ELECTROLYTIC NICKEL 100 TO 200 MICROINCHES.
4. DIMENSIONS ARE IN INCHES (MILLIMETERS).
5. PACKAGE LENGTH AND WIDTH DIMENSIONS DO NOT INCLUDE LID SEAL PROTRUSION .005 PER SIDE.
6. ALL GROUND LEADS AND GROUND PADDLE MUST BE SOLDERED TO PCB PF GROUND.



Evaluation PCB

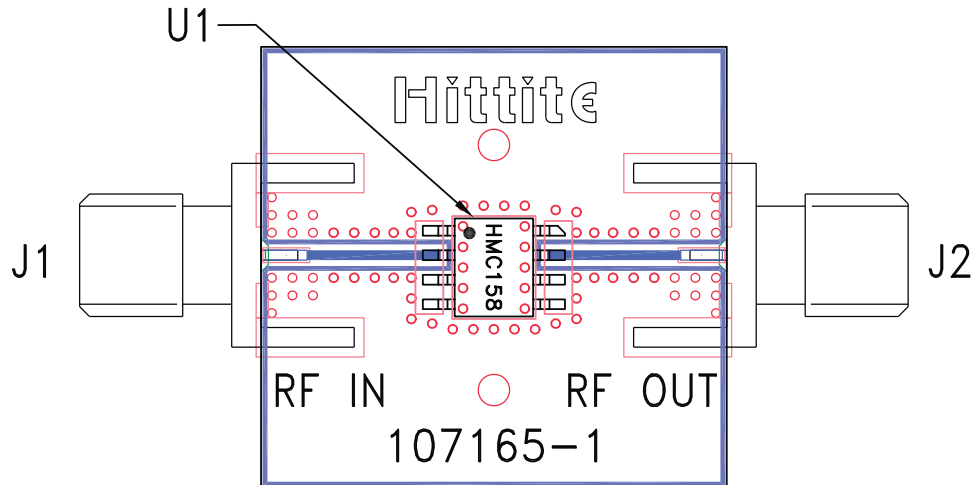

List of Materials for Evaluation PCB 107196 [1]

Item	Description
J1, J2	PCB Mount SMA Connector
U1	HMC158C8, Doubler
PCB [2]	107165 Eval Board

[1] Reference this number when ordering complete evaluation PCB

[2] Circuit Board Material: Rogers 4350

The circuit board used in the final application should be generated with proper RF circuit design techniques. Signal lines should have 50 ohm impedance while the package ground leads and exposed paddle should be connected directly to the ground plane similar to that shown. The evaluation circuit board shown is available from Hittite upon request.