

**Vectron International****Filter specification****TFS 120E****1/5****Measurement condition**

Ambient temperature:	23	°C
Input power level:	0	dBm
Terminating impedance: *		
Input:	1080 Ω    -7,4 pF	
Output:	1250 Ω    -6,7 pF	

**Characteristics****Remark:**

The reference level for the relative attenuation  $a_{rel}$  of the TFS 120E is the minimum of the pass band attenuation  $a_{min}$ . The minimum of the pass band attenuation  $a_{min}$  is defined as the insertion loss  $a_e$ . The centre frequency  $f_C$  is the arithmetic mean value of the upper and lower frequencies at the 3 dB filter attenuation level relative to the insertion loss  $a_e$ . The nominal frequency  $f_N$  is fixed at 120 MHz without any tolerance. The given values for both the relative attenuation  $a_{rel}$  and the group delay ripple have to be achieved at the frequencies given below even if the centre frequency  $f_C$  is shifted due to the temperature coefficient of frequency  $TC_f$  in the operating temperature range and due to a production tolerance for the centre frequency  $f_C$ .

<b>D a t a</b>	<b>typ. value</b>		<b>tolerance / limit</b>	
<b>Insertion loss</b> (reference level)	$a_e$	6 dB	max.	7 dB
<b>Nominal frequency</b>	$f_N$	-		120 MHz
<b>Centre frequency</b>	$f_C$	120 MHz		-
<b>1 dB Passband</b>	PB	290 kHz		$f_N \pm 100$ kHz
<b>Relative attenuation</b>	$a_{rel}$			
$f_N$	... $f_N \pm 0.1$ MHz	0.5 dB	max.	1 dB
$f_N \pm 0.3$ MHz	... $f_N \pm 0.5$ MHz	15 dB	min.	10 dB
$f_N - 0.5$ MHz	... $f_N - 0.7$ MHz	32 dB	min.	25 dB
$f_N + 0.5$ MHz	... $f_N + 1.05$ MHz	32 dB	min.	25 dB
$f_N - 0.7$ MHz	... $f_N - 1$ MHz	39 dB	min.	35 dB
$f_N + 1.05$ MHz	... $f_N + 1.35$ MHz	39 dB	min.	35 dB
$f_N - 1$ MHz	... $f_N - 80$ MHz	48 dB	min.	45 dB
$f_N + 1.35$ MHz	... $f_N + 80$ MHz	48 dB	min.	45 dB
<b>Group delay ripple within PB</b>		650 ns	max.	1000 ns
<b>Input power level **</b>			max.	18 dBm
<b>Permissible DC voltage between any two terminals</b>			max.	10 V
<b>Operating temperature range</b>	OTR	-	- 35 °C ... + 85 °C	°C
<b>Storage temperature range</b>		-	- 40 °C ... + 85 °C	°C
<b>Frequency inversion temperature</b>		29 °C		
<b>Temperature coefficient of frequency</b>	$TC_f$ ***	-0.04 ppm/K <sup>2</sup>		-

\*) The terminating impedances depend on parasitics and q-values of matching elements and the board used, and are to be understood as reference values only. Should there be additional questions do not hesitate to ask for an application note or contact our design team

\*\*) This power level is only allowed for short term operation (10% of the life time), the max. input power for continuous operation is max.10dBm only

\*\*\*)  $\Delta f(\text{Hz}) = TC_f(\text{ppm/K}^2) \times (T - T_0)^2 \times f_{T0}(\text{MHz})$

**Generated:****Checked / Approved:**

**Vectron International GmbH**  
**Potsdamer Straße 18**  
**D 14 513 TELTOW / Germany**  
**Tel: (+49) 3328 4784-0 / Fax: (+49) 3328 4784-30**  
**E-Mail: [tft@vectron.com](mailto:tft@vectron.com)**

Vectron International GmbH reserves the right to make changes to the product(s) and/or information contained herein without notice. No liability is assumed as a result of their use or application. No rights under any patent accompany the sale of any such product(s) or information..

**Filter characteristic**

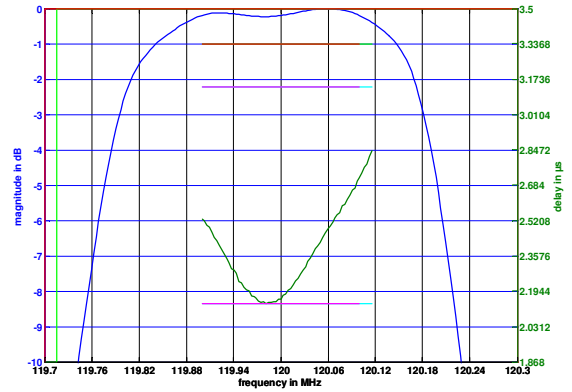
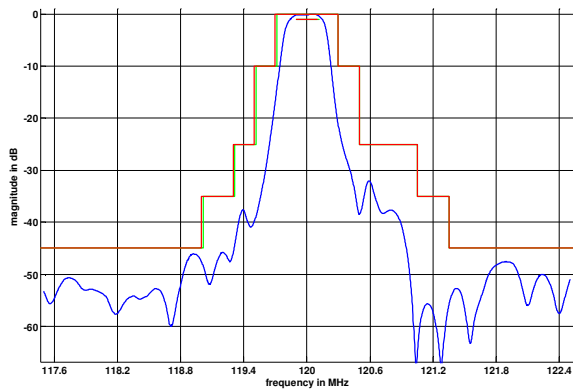

**Construction and pin connection**

(All dimensions in mm)

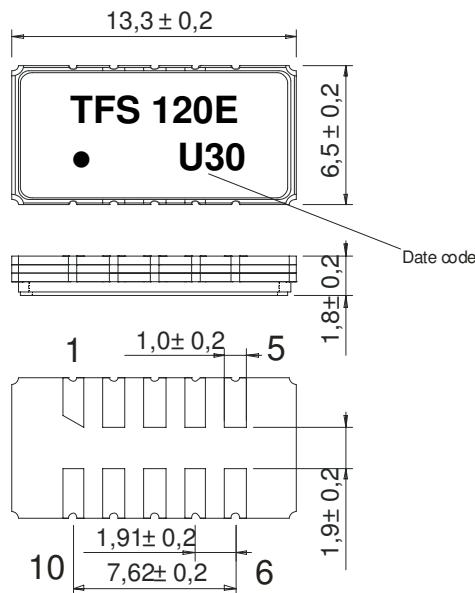

- 1 Input
- 2 Ground
- 3 Ground
- 4 Ground
- 5 Output
- 6 Output
- 7 Ground
- 8 Ground
- 9 Ground
- 10 Input

Date code: Year + week  
 U 2006  
 V 2007  
 W 2008  
 ...

**200 Ω Test circuit**

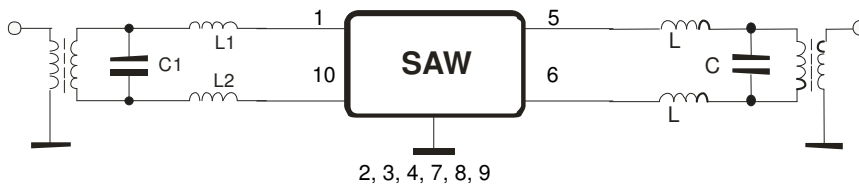

**Vectron International GmbH**  
 Potsdamer Straße 18  
 D 14 513 TELTOW / Germany  
 Tel: (+49) 3328 4784-0 / Fax: (+49) 3328 4784-30  
 E-Mail: [tft@vectron.com](mailto:tft@vectron.com)

Vectron International GmbH reserves the right to make changes to the product(s) and/or information contained herein without notice. No liability is assumed as a result of their use or application. No rights under any patent accompany the sale of any such product(s) or information..

**Stability characteristics, reliability**

After the following tests the filter shall meet the whole specification:

1. Shock: 500g, 1 ms, half sine wave, 3 shocks each plane;  
DIN IEC 68 T2 - 27
2. Vibration: 10 Hz to 500 Hz, 0,35 mm or 5 g respectively, 1 octave per min, 10 cycles per plane, 3 planes;  
DIN IEC 68 T2 - 6
3. Change of temperature: -55 °C to 125 °C / 30 min. each / 10 cycles  
DIN IEC 68 part 2 – 14 Test N
4. Resistance to solder heat (reflow): reflow possible: three times max.;  
for temperature conditions refer to the attached "Air reflow temperature conditions" on page 4;

This filter is RoHS compliant (2002/95/EG, 2005/618/EG)

**Packing**

- Tape & Reel: IEC 286 – 3, with exception of value for N and minimum bending radius;  
tape type II, embossed carrier tape with top cover tape on the upper side;
- |   |             |
|---|-------------|
| max. pieces of filters per reel:                    | 1700        |
| reel of empty components at start:                  | min. 300 mm |
| reel of empty components at start including leader: | min. 500 mm |
| trailer:  | min. 300 mm |

**Tape (all dimensions in mm)**

W	:24,00	+0,30/-0,10
Po	:4,00	± 0,1
Do	:1,50	+0,1/-0
E	:1,75	± 0,10
F	:11,50	± 0,10
G(min)	:0,60	
P2	:2,00	± 0,1
P1	:12,00	± 0,1
D1(min)	:1,50	
Ao	:7,10	± 0,10
Bo	:13,90	± 0,10
Ct	:21,5	± 0,1

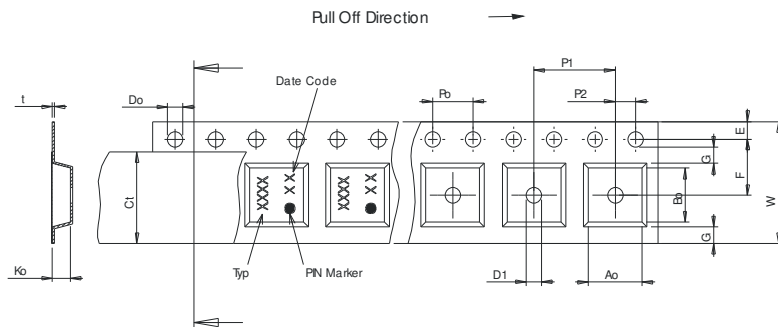

**Reel (all dimensions in mm)**

A	:330	
W1	:24,4	+2/-0
W2(max)	:30,4	
N(min)	:60	
C	:13,0	+0,5/-0,2

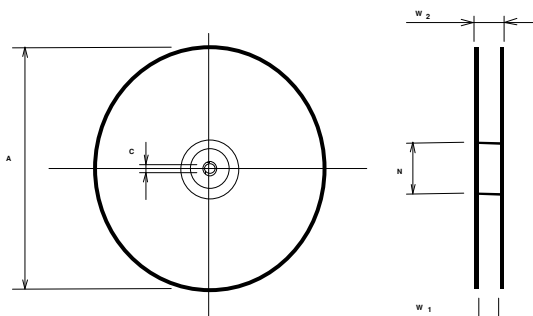

The minimum bending radius is 45 mm.

**Vectron International GmbH**  
**Potsdamer Straße 18**  
**D 14 513 TELTOW / Germany**  
**Tel: (+49) 3328 4784-0 / Fax: (+49) 3328 4784-30**  
**E-Mail: [tft@vectron.com](mailto:tft@vectron.com)**

Vectron International GmbH reserves the right to make changes to the product(s) and/or information contained herein without notice. No liability is assumed as a result of their use or application. No rights under any patent accompany the sale of any such product(s) or information..

## Air reflow temperature conditions

Conditions	Exposure
Average ramp-up rate (30°C to 217°C)	less than 3°C/second
> 100°C	between 300 and 600 seconds
> 150°C	between 240 and 500 seconds
> 217°C	between 30 and 150 seconds
Peak temperature	max. 260°C
Time within 5°C of actual peak temperature	between 10 and 30 seconds
Cool-down rate (Peak to 50°C)	less than 6°C/second
Time from 30°C to Peak temperature	no greater than 300 seconds

Chip-mount air reflow profile

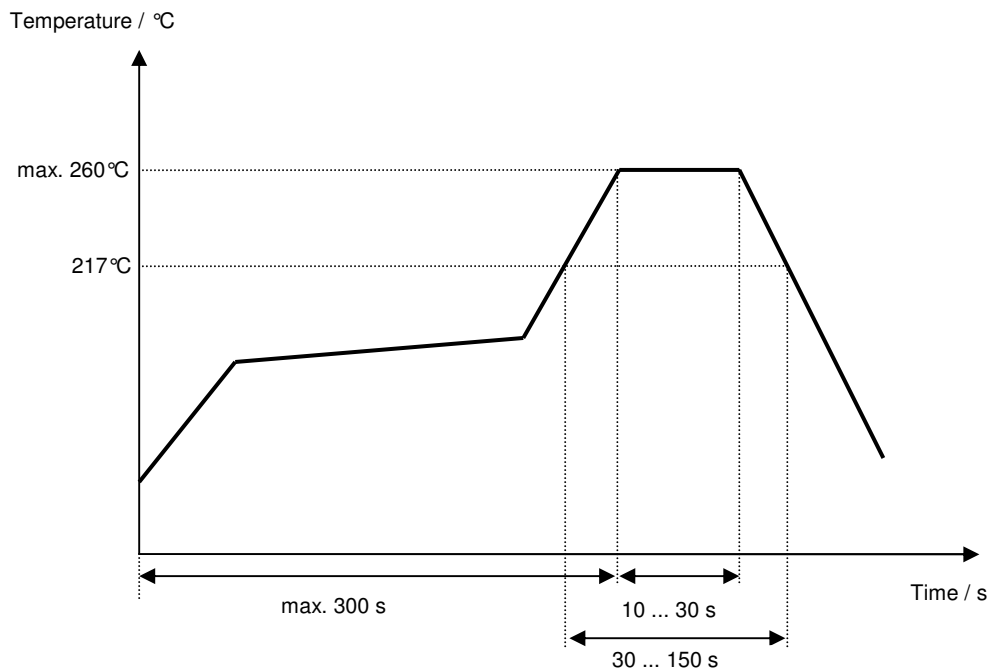

Vectron International GmbH  
 Potsdamer Straße 18  
 D 14 513 TELTOW / Germany  
 Tel: (+49) 3328 4784-0 / Fax: (+49) 3328 4784-30  
 E-Mail: [tft@vectron.com](mailto:tft@vectron.com)

Vectron International GmbH reserves the right to make changes to the product(s) and/or information contained herein without notice. No liability is assumed as a result of their use or application. No rights under any patent accompany the sale of any such product(s) or information..

**History**

<b>Version</b>	<b>Reason of Changes</b>	<b>Name</b>	<b>Date</b>
1.0	- generate development specification	Martens	27.10.2004
1.1	- change stability characteristics and correct relative attenuation	Strehl	18.05.2006
1.2	- terminating impedances, typical values, filter characteristics and matching configuration added	Pfeiffer	27.07.2006
2.0	- upper rejection relaxed as per customer discussion (21.09.2012)	TCUK	21.09.2012