

Features

- For WiMAX applications
- Usable bandwidth 5 MHz
- High attenuation
- No impedance matching required for operation at 50 Ω
- Single-ended operation
- Ceramic Surface Mount Package (SMP)
- Hermetic
- RoHS compliant (2002/95/EC), Pb-free 

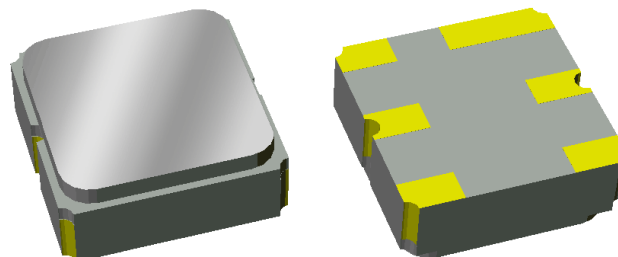

Package

Surface Mount 3.00 x 3.00 x 1.22 mm
SMP-12

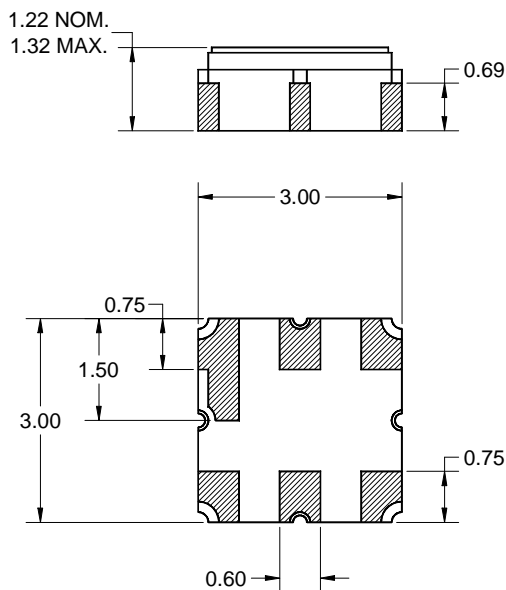

Pin Configuration

Bottom View

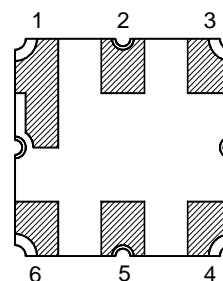

Single-ended Configuration

Pin No.	Description
2	Input
5	Output
1,3,4,6	Case ground

Dimensions shown are nominal in millimeters
All tolerances are ±0.15mm except overall length and width ±0.10mm

Body: Al_2O_3 ceramic
Lid: Kovar, Ni plated
Terminations: Au plating 0.5 - 1.0µm, over a 2 - 6µm Ni plating

Electrical Specifications ⁽¹⁾

Operating Temperature Range: ⁽²⁾ -40 to +85 °C

Parameter ⁽³⁾	Minimum	Typical ⁽⁴⁾	Maximum	Unit
Center Frequency	-	810	-	MHz
Maximum Insertion Loss 807.5 - 812.5 MHz	-	4.6	6.0	dB
Amplitude Ripple ⁽⁵⁾ 807.5 - 812.5 MHz	-	0.7	2.0	dB
Group Delay Variation 807.5 - 812.5 MHz	-	88	150	ns
Absolute Attenuation				
10 - 770 MHz	50	54	-	dB
770 - 793 MHz	30	48	-	dB
793 - 795 MHz	20	41	-	dB
795 - 797 MHz	10	32	-	dB
823 - 825 MHz	10	32	-	dB
825 - 827 MHz	20	41	-	dB
827 - 850 MHz	30	48	-	dB
850 - 1500 MHz	50	54	-	dB
1500 - 2500 MHz	35	38	-	dB
Source Impedance ⁽⁶⁾	-	50	-	Ω
Load Impedance ⁽⁶⁾	-	50	-	Ω

Notes:

1. All specifications are based on the TriQuint test circuit shown below
2. In production, devices will be tested at room temperature to a guardbanded specification to ensure electrical compliance over temperature
3. Electrical margin has been built into the design to account for the variations due to temperature drift and manufacturing tolerances
4. Typical values are based on average measurements at room temperature
5. Amplitude ripple is defined as the worst case difference between the peak and adjacent valley within the defined frequency points
6. This is the optimum impedance in order to achieve the performance shown

Test Circuit:

50 Ω
Single-ended
No impedance matching
required

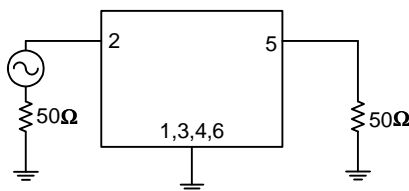

50 Ω
Single-ended
No impedance matching
required

Typical Performance (at room temperature)

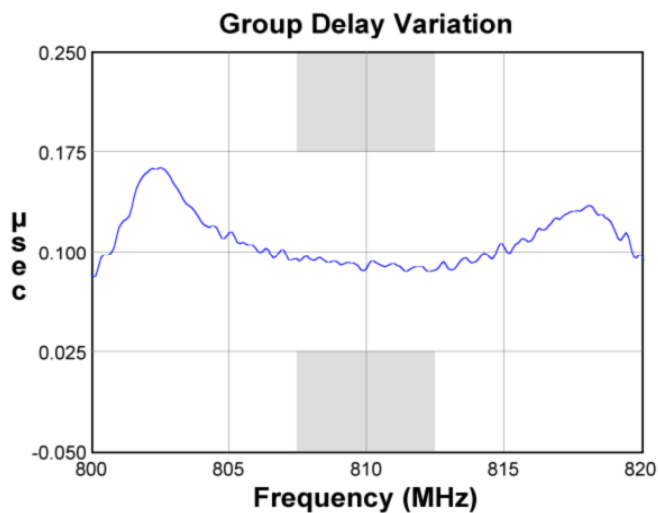
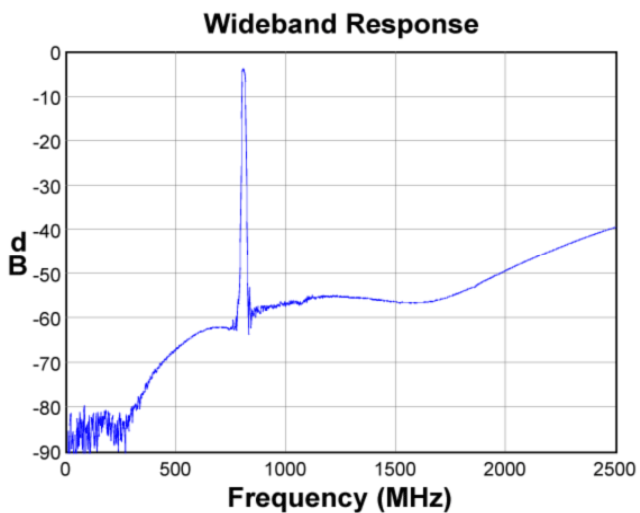
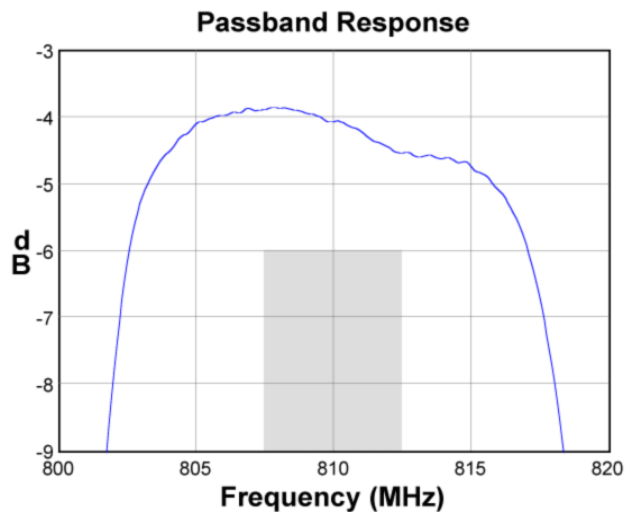
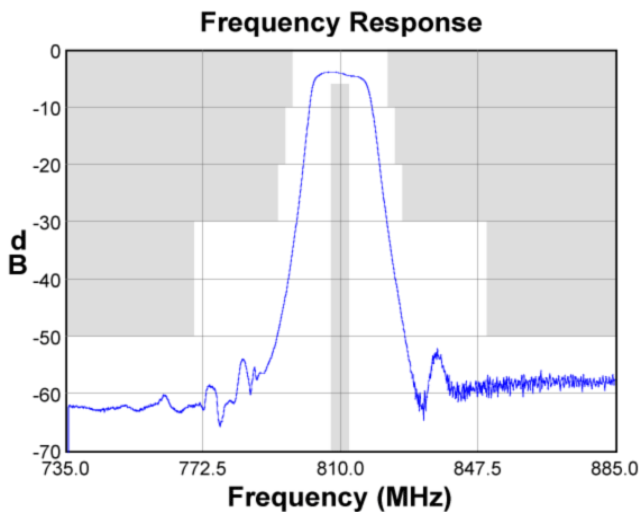

Input Smith Chart

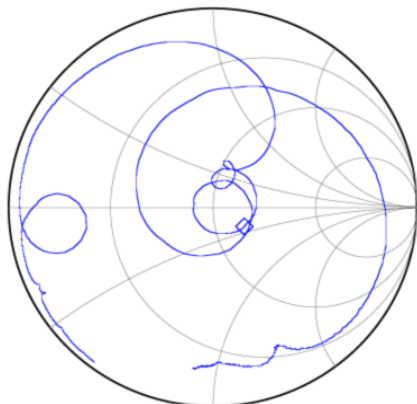

Output Smith Chart

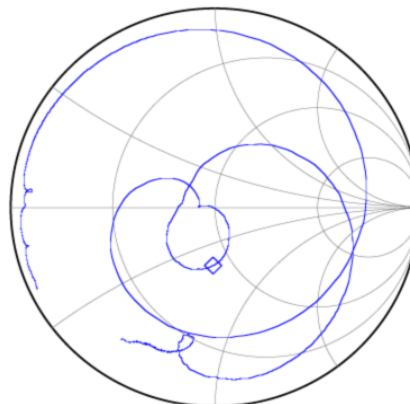

Matching Schematics

50 Ω
Single-ended
No impedance
matching required

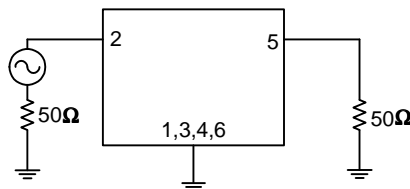

50 Ω
Single-ended
No impedance
matching required

Marking

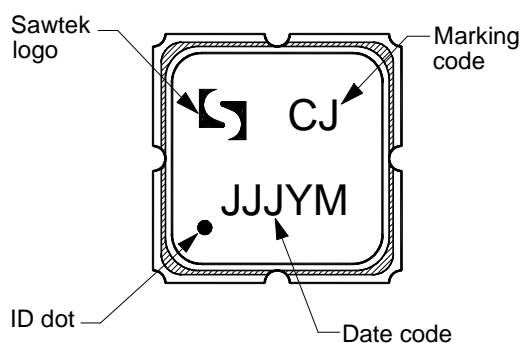

The date code consists of: JJJ = Julian day,
Y = last digit of year, M = manufacturing site code

PCB Footprint

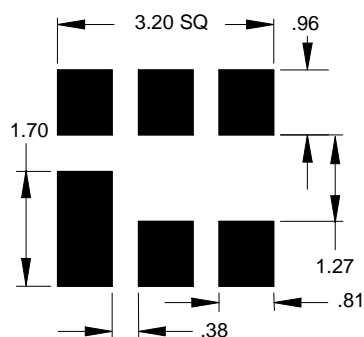

This footprint represents a recommendation only
Dimensions shown are nominal in millimeters

Tape and Reel

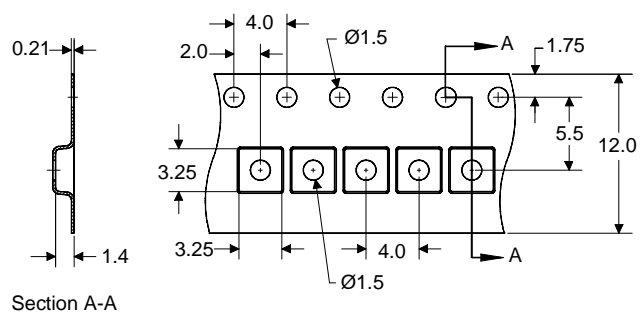
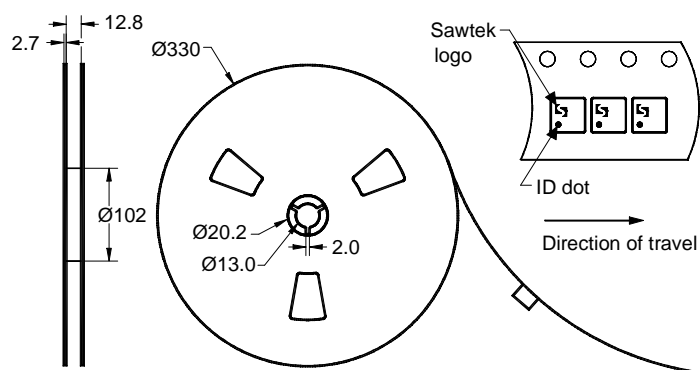

Dimensions shown are nominal in millimeters
Packaging quantity: 5000 units/reel

Maximum Ratings

Parameter	Symbol	Minimum	Maximum	Unit
Operating Temperature Range	T	-40	+85	°C
Storage Temperature Range	T _{stg}	-40	+85	°C

Important Notes

Warnings

- Electrostatic Sensitive Device (ESD) 
- Avoid ultrasonic exposure

RoHS Compliance

- This product complies with EU directive 2002/95/EC (RoHS) 

Solderability

- Compatible with JESD22-B102, Pb-free process, 260C peak reflow temperature ([see soldering profile](#))

Links to Additional Technical Information

[PCB Layout Tips](#)

[Qualification Flowchart](#)

[Soldering Profile](#)

[S-Parameters](#)

[RoHS Information](#)

[Other Technical Information](#)

TriQuint's liability is limited only to the Surface Acoustic Wave (SAW) component(s) described in this data sheet. TriQuint does not accept any liability for applications, processes, circuits or assemblies, which are implemented using any TriQuint component described in this data sheet.

Contact Information

TriQuint 
SEMICONDUCTOR

PO Box 609501
Orlando, FL 32860-9501
USA

Phone: +1 (407) 886-8860
Fax: +1 (407) 886-7061
Email: info-product@tqs.com
Web: www.triquint.com

Or contact one of our worldwide
Network of [sales offices](#),
[Representatives or distributors](#)