

Product Features

- Low Noise Figure, 0.5 dB
- Gain, 17 dB at 2 GHz
- High Output IP3, +31 dBm
- Output Power at 1dB comp., +19 dBm
- Low Current, 30mA
- Wide bandwidth
- External biasing and matching required



TAV-581+

CASE STYLE: FG873
PRICE: \$1.19 ea. QTY. (20)

+RoHS Compliant

The +Suffix identifies RoHS Compliance. See our web site for RoHS Compliance methodologies and qualifications

Typical Applications

- Cellular
- ISM
- GSM
- WCDMA
- WiMax
- WLAN
- UNII and HIPERLAN

General Description

TAV-581+ is an ultra-low noise, high IP3 transistor device, manufactured using E-PHEMT* technology enabling it to work with a single positive supply voltage. It has outstanding Noise Figure, particularly below 2.5 GHz, and when combining this noise figure with high IP3 performance in a single device it makes it an ideal amplifier for demanding base station applications. We offer these units assembled into a complete module, 50Ω in/out, noise matched and fully specified. For more information please see our TAMP family of models on our web site.

simplified schematic and pin description

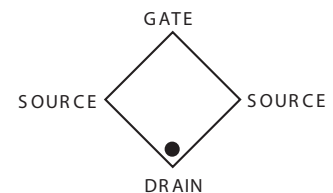
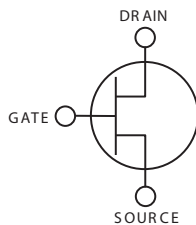

Function	Pad Number	Description
Source	2 & 4	Source terminal, normally connected to ground
Gate	3	Gate used for RF input
Drain	1	Drain used for RF output

* Enhancement mode Pseudomorphic High Electron Mobility Transistor.

Notes

- A. Performance and quality attributes and conditions not expressly stated in this specification document are intended to be excluded and do not form a part of this specification document.
 B. Electrical specifications and performance data contained in this specification document are based on Mini-Circuit's applicable established test performance criteria and measurement instructions.
 C. The parts covered by this specification document are subject to Mini-Circuits standard limited warranty and terms and conditions (collectively, "Standard Terms"); Purchasers of this part are entitled to the rights and benefits contained therein. For a full statement of the Standard Terms and the exclusive rights and remedies thereunder, please visit Mini-Circuits' website at www.minicircuits.com/MCLStore/terms.jsp



Electrical Specifications at $T_{AMB}=25^{\circ}\text{C}$, Frequency 0.45 to 6 GHz

Symbol	Parameter	Condition	Min.	Typ.	Max.	Units
DC Specifications						
V_{GS}	Operational Gate Voltage	$V_{DS}=3\text{V}$, $I_{DS}=30\text{ mA}$	0.28	0.39	0.5	V
V_{TH}	Threshold Voltage	$V_{DS}=3\text{V}$, $I_{DS}=4\text{ mA}$	0.18	0.26	0.38	V
I_{DSS}	Saturated Drain Current	$V_{DS}=3\text{V}$, $V_{GS}=0\text{ V}$		1.0	5.0	μA
G_m	Transconductance	$V_{DS}=3\text{V}$, $G_m=\Delta I_{DS}/\Delta V_{GS}$ $\Delta V_{GS}=V_{GS1}-V_{GS2}$ $V_{GS1}=V_{GS}$ at $I_{DS}=30\text{ mA}$ $V_{GS2}=V_{GS1}+0.05\text{V}$	— 230 — —	— 327 — —	— 560 — —	mS
I_{GSS}	Gate leakage Current	$V_{GD}=V_{GS}=-3\text{V}$			200	μA
RF Specifications, $Z_0=50\text{ Ohms}$ (Figure 1)						
$NF^{(1)}$	Noise Figure	$V_{DS}=3\text{V}$, $I_{DS}=30\text{ mA}$ $V_{DS}=4\text{V}$, $I_{DS}=30\text{ mA}$	f=0.9 GHz f=2.0 GHz f=3.9 GHz f=5.8 GHz f=0.9 GHz f=2.0 GHz	0.4 0.5 0.9 1.5 0.4 0.5	— 0.9 — — — —	dB
Gain	Gain	$V_{DS}=3\text{V}$, $I_{DS}=30\text{ mA}$ $V_{DS}=4\text{V}$, $I_{DS}=30\text{ mA}$	f=0.9 GHz f=2.0 GHz f=3.9 GHz f=5.8 GHz f=0.9 GHz f=2.0 GHz	— 15.0 — — 22.7 17.2	22.9 17.3 18.5 — 22.7 17.2	dB
OIP3	Output IP3	$V_{DS}=3\text{V}$, $I_{DS}=30\text{ mA}$ $V_{DS}=4\text{V}$, $I_{DS}=30\text{ mA}$	f=0.9 GHz f=2.0 GHz f=3.9 GHz f=5.8 GHz f=0.9 GHz f=2.0 GHz	28.3 30.3 33.0 34.7 28.1 30.0	— — — — — —	dBm
$P_{1dB}^{(2)}$	Power output at 1 dB Compression	$V_{DS}=3\text{V}$, $I_{DS}=30\text{ mA}$ $V_{DS}=4\text{V}$, $I_{DS}=30\text{ mA}$	f=0.9 GHz f=2.0 GHz f=3.9 GHz f=5.8 GHz f=0.9 GHz f=2.0 GHz	17.8 18.3 18.8 19.1 19.4 20.2	— — — — — —	dBm

Absolute Maximum Ratings⁽³⁾

Symbol	Parameter	Max.	Units
$V_{DS}^{(4)}$	Drain-Source Voltage	5	V
$V_{GS}^{(4)}$	Gate-Source Voltage	-5 to 0.7	V
$V_{GD}^{(4)}$	Gate-Drain Voltage	-5 to 0.7	V
$I_{DS}^{(4)}$	Drain Current	100	mA
I_{GS}	Gate Current	2	mA
P_{DISS}	Total Dissipated Power	550	mW
$P_{IN}^{(5)}$	RF Input Power	17	dBm
T_{CH}	Channel Temperature	150	$^{\circ}\text{C}$
T_{OP}	Operating Temperature	-40 to 85	$^{\circ}\text{C}$
T_{STD}	Storage Temperature	-65 to 150	$^{\circ}\text{C}$
Θ_{JC}	Thermal Resistance	112	$^{\circ}\text{C}/\text{W}$

Notes:

- (1) Includes testboard loss (measured in Mini-Circuits test board TB-154)
- (2) During Compression, I_{DS} increases to 48mA typ.
- (3) Operation of this device above any one of these parameters may cause permanent damage.
- (4) Assumes DC quiescent conditions.
- (5) I_{GS} is limited to 2 mA during test.

Notes

- A. Performance and quality attributes and conditions not expressly stated in this specification document are intended to be excluded and do not form a part of this specification document.
- B. Electrical specifications and performance data contained in this specification document are based on Mini-Circuit's applicable established test performance criteria and measurement instructions.
- C. The parts covered by this specification document are subject to Mini-Circuits standard limited warranty and terms and conditions (collectively, "Standard Terms"); Purchasers of this part are entitled to the rights and benefits contained therein. For a full statement of the Standard Terms and the exclusive rights and remedies thereunder, please visit Mini-Circuits' website at www.minicircuits.com/MCLStore/terms.jsp



Characterization Test Circuit

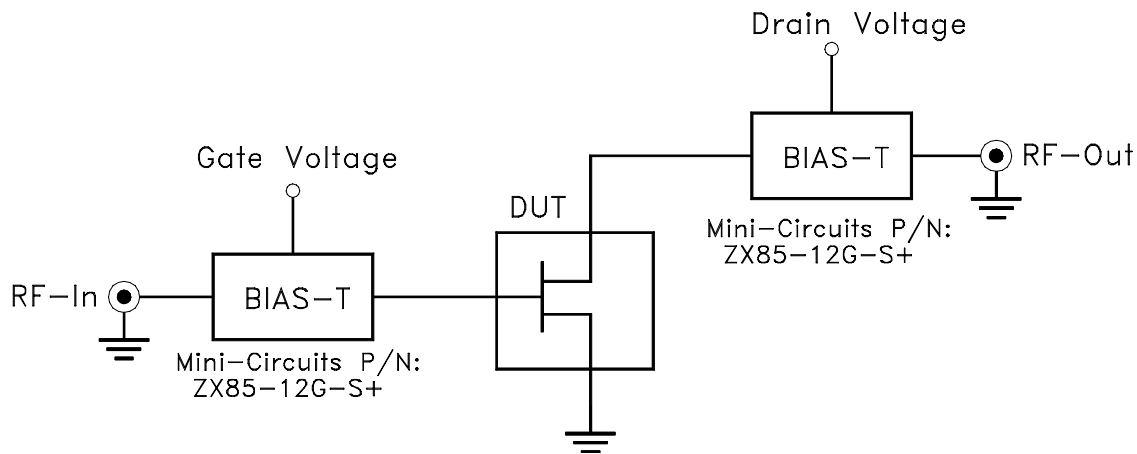

Fig 1. Block Diagram of Test Circuit used for characterization. (DUT soldered on Mini-Circuits Test Board TB-154)

Gain, Output power at 1dB compression (P1 dB) and output IP3 (OIP3) are measured using R&S Network Analyzer ZVA-24. Noise Figure measured using Agilent's Noise Figure meter N8975A and noise source N4000A.

Conditions:

1. Drain voltage (with reference to source, V_{DS})= 3 or 4V as shown.
2. Gate Voltage (with reference to source, V_{GS}) is set to obtain desired Drain-Source current (IDS) as shown in graphs or specification table.
3. Gain: Pin= -25dBm
4. Output IP3 (OIP3): Two tones, spaced 1 MHz apart, 0 dBm/tone at output.
5. No external matching components used.

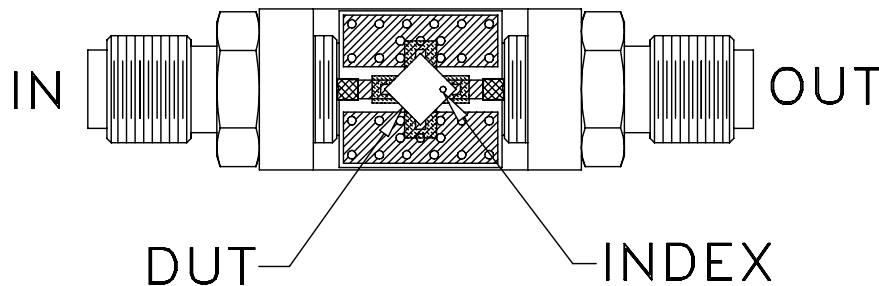

Fig 2. Test Board used for characterization, Mini-Circuits P/N TB-154 (Material: Rogers 4350, Thickness: 0.02")

Notes

- A. Performance and quality attributes and conditions not expressly stated in this specification document are intended to be excluded and do not form a part of this specification document.
- B. Electrical specifications and performance data contained in this specification document are based on Mini-Circuit's applicable established test performance criteria and measurement instructions.
- C. The parts covered by this specification document are subject to Mini-Circuits standard limited warranty and terms and conditions (collectively, "Standard Terms"); Purchasers of this part are entitled to the rights and benefits contained therein. For a full statement of the Standard Terms and the exclusive rights and remedies thereunder, please visit Mini-Circuits' website at www.minicircuits.com/MCLStore/terms.jsp



Typical Performance Curves

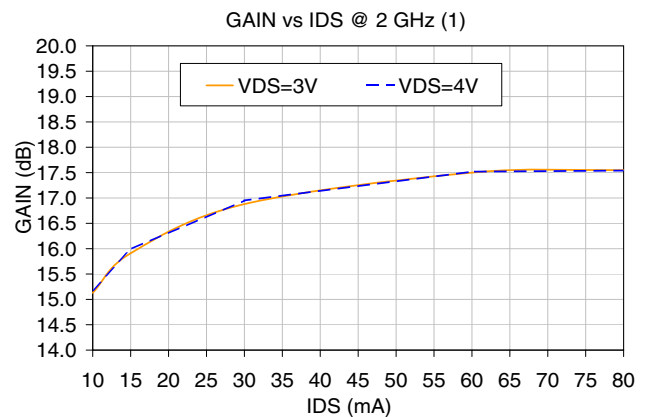
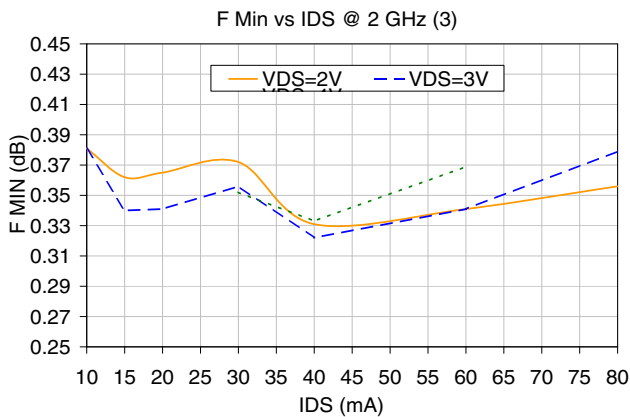
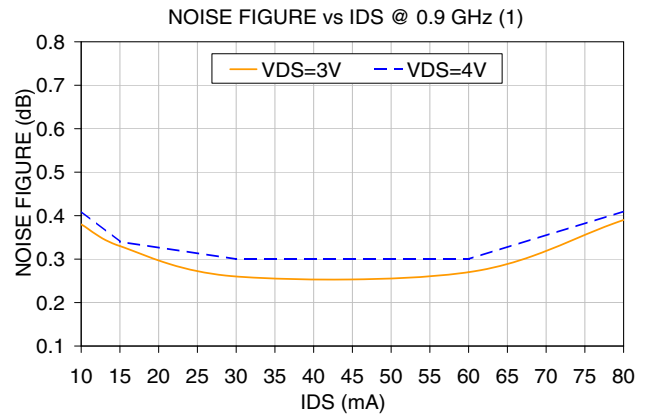
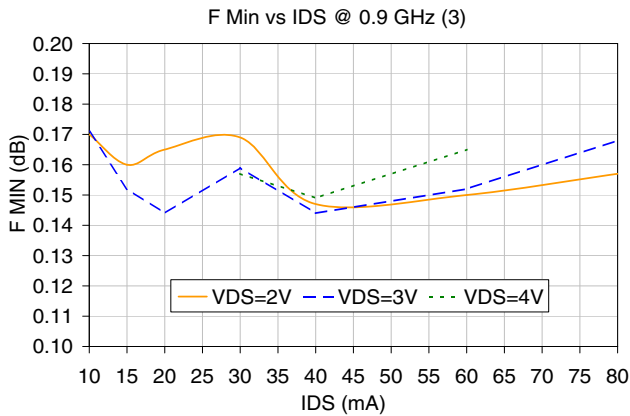
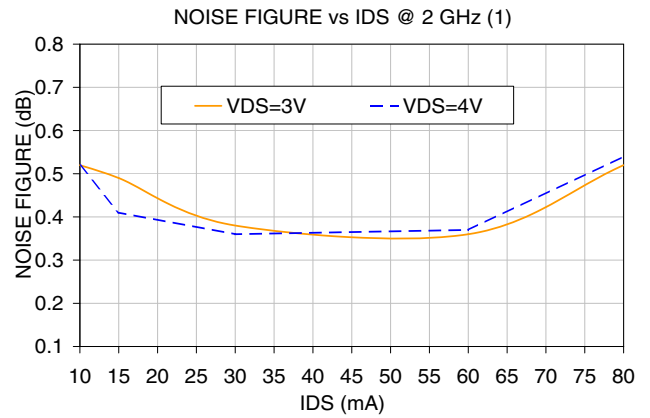
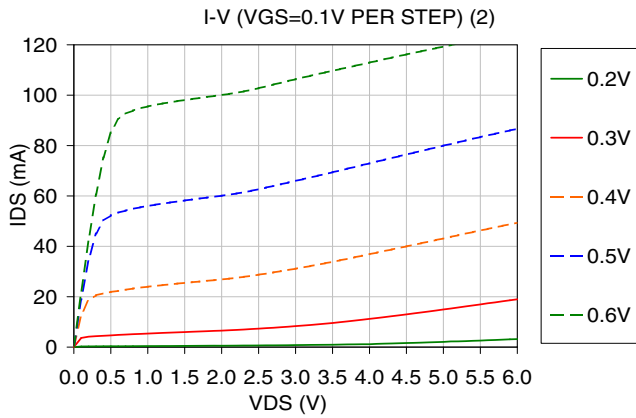

- (1) Includes test board loss, set-up and conditions per Figure 1.
- (2) Measured using HP4155B semiconductor parameter analyzer.
- (3) F Min is minimum Noise Figure.
- (4) Drain current was allowed to increase during compression measurement.

Notes

- A. Performance and quality attributes and conditions not expressly stated in this specification document are intended to be excluded and do not form a part of this specification document.
- B. Electrical specifications and performance data contained in this specification document are based on Mini-Circuit's applicable established test performance criteria and measurement instructions.
- C. The parts covered by this specification document are subject to Mini-Circuits standard limited warranty and terms and conditions (collectively, "Standard Terms"); Purchasers of this part are entitled to the rights and benefits contained therein. For a full statement of the Standard Terms and the exclusive rights and remedies thereunder, please visit Mini-Circuits' website at www.minicircuits.com/MCLStore/terms.jsp



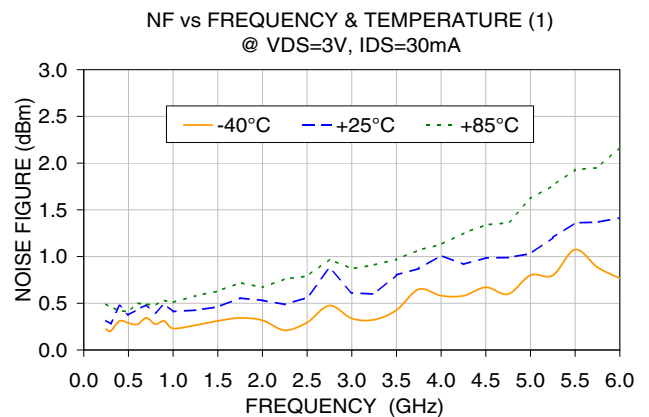
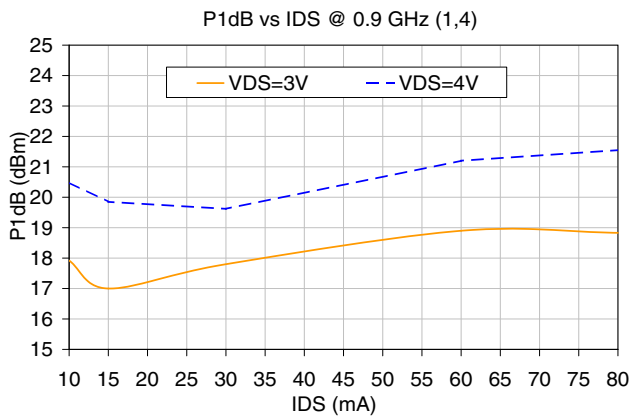
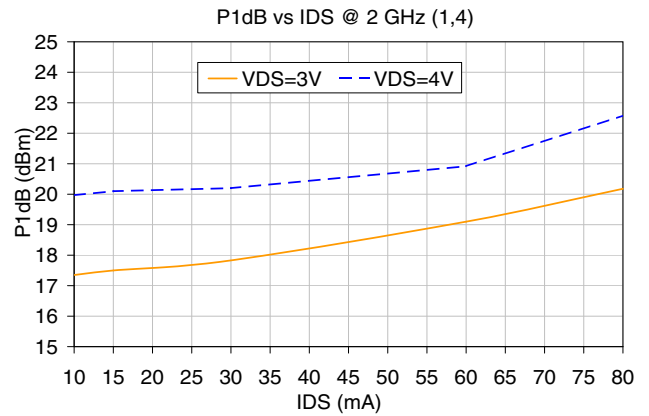
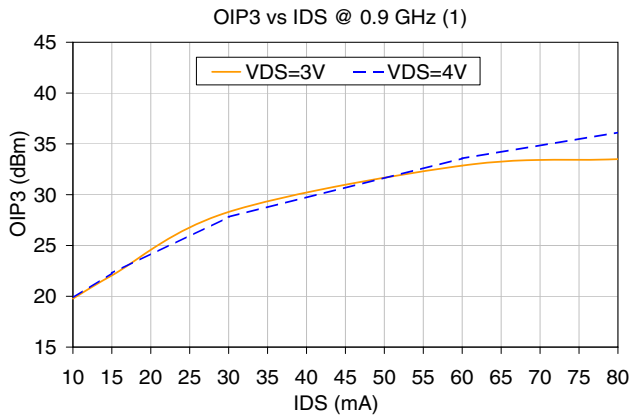
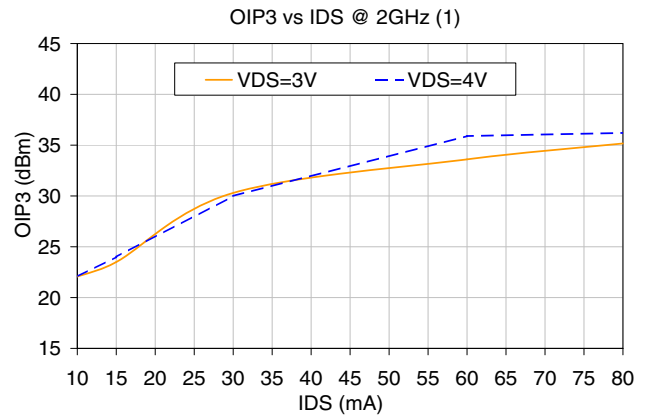
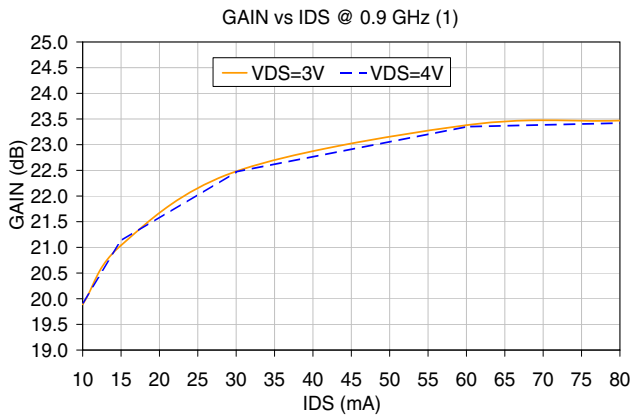

- (1) Includes test board loss, set-up and conditions per Figure 1.
- (2) Measured using HP4155B semiconductor parameter analyzer.
- (3) F Min is minimum Noise Figure.
- (4) Drain current was allowed to increase during compression measurement.

Notes

- A. Performance and quality attributes and conditions not expressly stated in this specification document are intended to be excluded and do not form a part of this specification document.
- B. Electrical specifications and performance data contained in this specification document are based on Mini-Circuit's applicable established test performance criteria and measurement instructions.
- C. The parts covered by this specification document are subject to Mini-Circuits standard limited warranty and terms and conditions (collectively, "Standard Terms"); Purchasers of this part are entitled to the rights and benefits contained therein. For a full statement of the Standard Terms and the exclusive rights and remedies thereunder, please visit Mini-Circuits' website at www.minicircuits.com/MCLStore/terms.jsp



GAIN vs FREQUENCY & TEMPERATURE (1)
@ VDS=3V, IDS=30mA

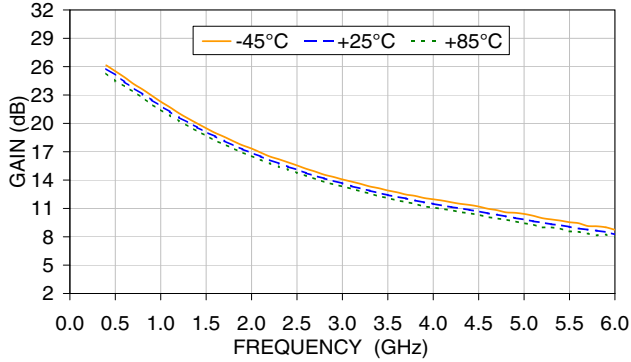

OIP3 vs FREQUENCY & TEMPERATURE (1)
@ VDS=3V, IDS=30mA

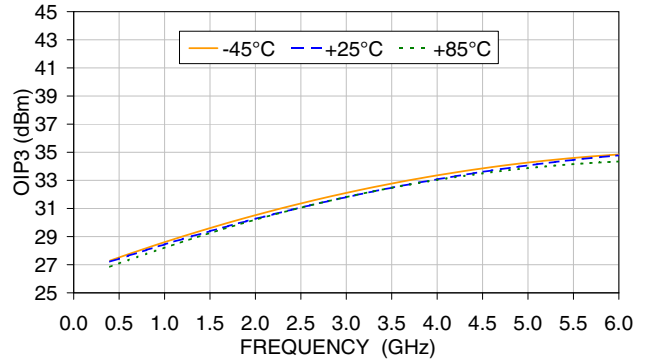

P1dB vs FREQUENCY & TEMPERATURE (1,4)
@ VDS=3V, IDS=30mA

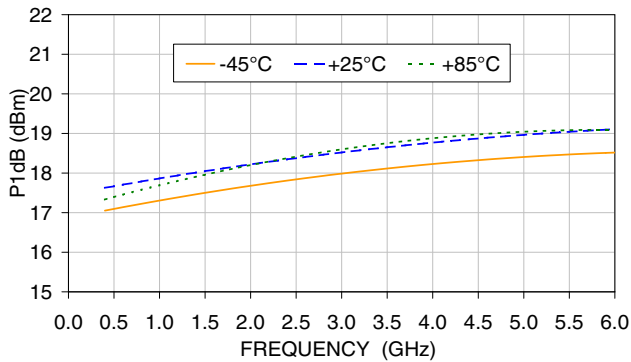

NF vs FREQUENCY & TEMPERATURE (1)
@ VDS=4V, IDS=30mA

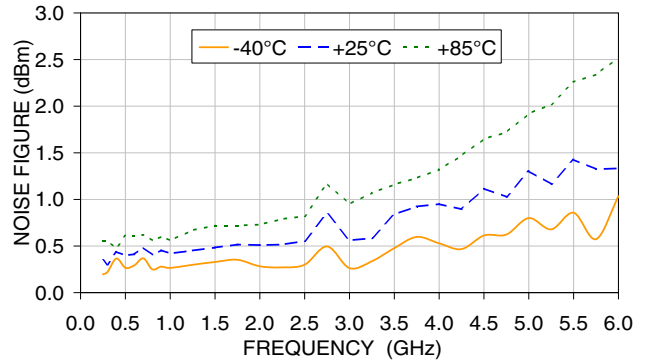

GAIN vs FREQUENCY & TEMPERATURE (1)
@ VDS=4V, IDS=30mA

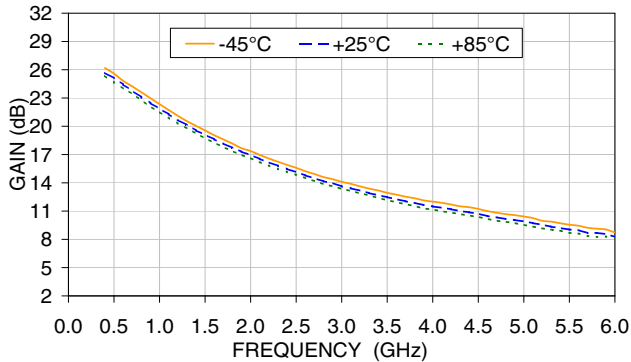

OIP3 vs FREQUENCY & TEMPERATURE
@ VDS=4V, IDS=30mA

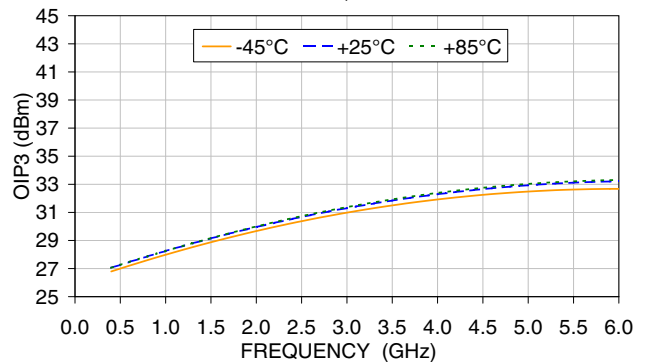

- (1) Includes test board loss, set-up and conditions per Figure 1.
- (2) Measured using HP4155B semiconductor parameter analyzer.
- (3) F Min is minimum Noise Figure.
- (4) Drain current was allowed to increase during compression measurement.

Notes

- A. Performance and quality attributes and conditions not expressly stated in this specification document are intended to be excluded and do not form a part of this specification document.
- B. Electrical specifications and performance data contained in this specification document are based on Mini-Circuit's applicable established test performance criteria and measurement instructions.
- C. The parts covered by this specification document are subject to Mini-Circuits standard limited warranty and terms and conditions (collectively, "Standard Terms"); Purchasers of this part are entitled to the rights and benefits contained therein. For a full statement of the Standard Terms and the exclusive rights and remedies thereunder, please visit Mini-Circuits' website at www.minicircuits.com/MCLStore/terms.jsp



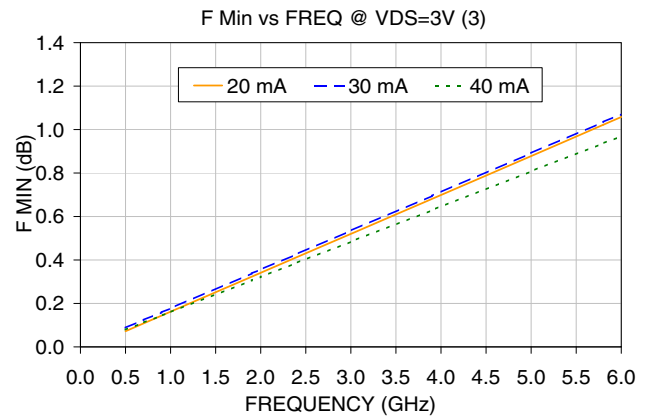
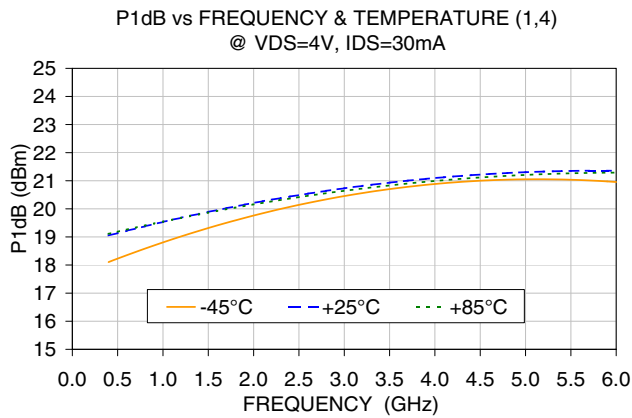

- (1) Includes test board loss, set-up and conditions per Figure 1.
- (2) Measured using HP4155B semiconductor parameter analyzer.
- (3) F Min is minimum Noise Figure.
- (4) Drain current was allowed to increase during compression measurement.

Reference Plane Location for S and Noise Parameters *(see data in pages 8 & 9)*

(Refer to Application Note AN-60-040)

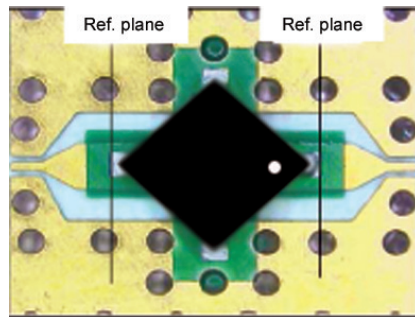

Fig 3. Reference Plane Location

Notes:

Noise parameters were measured over 0.5 to 6 GHz by Modelithics® using a solid state tuner-based NP noise parameter test system available from Maury Microwave. F Min, optimum source reflection coefficient and noise resistance values are calculated values based on a set of measurements made at approximately 16 different impedances. Some data smoothing was applied to arrive at the presented data set.

S-parameters were measured by Modelithics® on an Anritsu Lightning vector network analyzer over 0.1 to 18GHz using 350um pitch RF probes from GGB industries combined with customized thru-reflect-line (TRL) calibration standards. The reference plane is at the device package leads, as shown in the picture.

Notes

- A. Performance and quality attributes and conditions not expressly stated in this specification document are intended to be excluded and do not form a part of this specification document.
- B. Electrical specifications and performance data contained in this specification document are based on Mini-Circuit's applicable established test performance criteria and measurement instructions.
- C. The parts covered by this specification document are subject to Mini-Circuits standard limited warranty and terms and conditions (collectively, "Standard Terms"); Purchasers of this part are entitled to the rights and benefits contained therein. For a full statement of the Standard Terms and the exclusive rights and remedies thereunder, please visit Mini-Circuits' website at www.minicircuits.com/MCLStore/terms.jsp

Typical S-parameters, $V_{DS}=3V$ and $I_{DS}=30\text{ mA}$ (Fig. 3)

Freq. (GHz)	S11		S21			S12		S22		MSG/MAG (dB)
	Mag.	Ang.	Mag.	Mag (dB)	Ang.	Mag.	Ang.	Mag.	Ang.	
0.1	0.99	-16.36	23.19	27.31	169.5	0.009	86.4	0.60	-12.94	34.0
0.5	0.88	-73.63	18.30	25.25	132.3	0.037	52.2	0.47	-52.76	27.0
0.9	0.77	-112.16	13.45	22.57	108.1	0.05	36.6	0.35	-79.99	24.3
1.0	0.76	-120.13	12.51	21.95	103.4	0.052	34.2	0.33	-85.89	23.8
1.5	0.70	-149.97	9.11	19.19	84.2	0.059	24.0	0.25	-109.19	21.9
1.9	0.68	-167.63	7.42	17.41	72.0	0.063	19.5	0.21	-124.99	20.7
2.0	0.68	-171.42	7.09	17.02	69.3	0.065	18.2	0.20	-128.70	20.4
2.5	0.67	171.27	5.80	15.27	56.2	0.07	13.5	0.17	-146.31	19.2
3.0	0.66	156.22	4.90	13.80	44.0	0.075	8.8	0.15	-163.82	18.1
4.0	0.67	130.42	3.73	11.43	21.4	0.087	-0.3	0.13	161.15	16.0
5.0	0.68	107.77	3.02	9.59	0.0	0.099	-10.8	0.14	127.97	13.2
6.0	0.70	86.82	2.53	8.06	-20.8	0.113	-22.5	0.16	98.63	11.7
7.0	0.73	66.89	2.17	6.71	-41.4	0.125	-35.2	0.20	74.15	10.6
8.0	0.75	47.68	1.88	5.49	-61.7	0.136	-48.6	0.26	53.20	9.7
9.0	0.79	28.73	1.63	4.27	-81.9	0.145	-63.3	0.32	34.25	9.1
10.0	0.83	9.67	1.42	3.04	-102.2	0.15	-78.4	0.39	16.29	8.8
11.0	0.86	-8.89	1.23	1.77	-122.3	0.151	-94.0	0.47	-0.68	9.1
12.0	0.89	-26.76	1.06	0.47	-142.1	0.15	-109.6	0.54	-17.06	8.5
13.0	0.91	-44.42	0.91	-0.86	-162.0	0.146	-125.5	0.59	-33.39	7.9
14.0	0.93	-60.99	0.77	-2.25	-178.8	0.139	-140.9	0.65	-49.07	7.5
15.0	0.94	-73.61	0.66	-3.64	-163.1	0.131	-153.9	0.70	-61.42	7.0
16.0	0.96	-83.75	0.56	-5.10	-149.1	0.119	-163.5	0.74	-72.07	6.7
17.0	0.96	-94.86	0.47	-6.51	-134.2	0.109	-174.6	0.77	-83.99	6.4
18.0	0.95	-106.68	0.40	-7.98	-118.5	0.101	-174.5	0.80	-97.27	6.0

MAXIMUM STABLE GAIN (MSG)/MAXIMUM AVAILABLE GAIN (MAG) vs. FREQUENCY

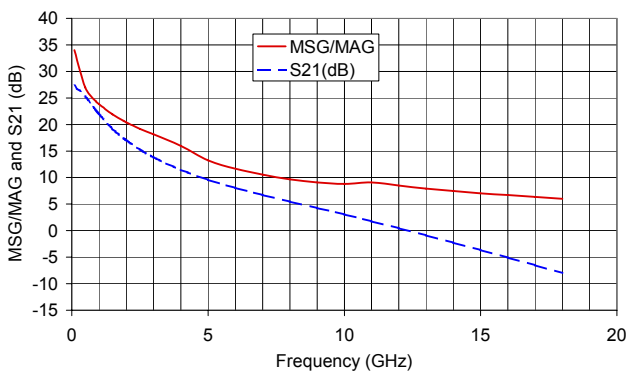

Typical Noise Parameters, $V_{DS}=3V$ and $I_{DS}=30\text{ mA}$ (Fig. 3)

Freq. (GHz)	F Min. (dB)	Γ_{Opt} (Magnitude)	Γ_{Opt} (Angle)	Rn/50	Ga
					Associated Gain (dB)
0.5	0.09	0.33	16.30	0.07	26.6
0.7	0.12	0.33	28.96	0.07	24.7
0.9	0.16	0.34	41.34	0.06	23.1
1.0	0.18	0.35	47.42	0.06	22.4
1.9	0.34	0.38	99.05	0.03	17.8
2.0	0.36	0.39	104.44	0.03	17.5
2.4	0.43	0.40	125.31	0.03	16.3
3.0	0.54	0.42	154.52	0.03	14.9
3.9	0.70	0.44	-166.36	0.06	13.3
5.0	0.89	0.46	-126.19	0.11	11.8
5.8	1.04	0.47	-102.25	0.16	10.7
6.0	1.07	0.47	-96.96	0.18	10.5

Notes:
 F Min.: Minimum Noise Figure
 Γ_{Opt} : Optimum Source Reflection Coefficient
 Rn: Equivalent noise resistance

Notes

- A. Performance and quality attributes and conditions not expressly stated in this specification document are intended to be excluded and do not form a part of this specification document.
- B. Electrical specifications and performance data contained in this specification document are based on Mini-Circuit's applicable established test performance criteria and measurement instructions.
- C. The parts covered by this specification document are subject to Mini-Circuits standard limited warranty and terms and conditions (collectively, "Standard Terms"); Purchasers of this part are entitled to the rights and benefits contained therein. For a full statement of the Standard Terms and the exclusive rights and remedies thereunder, please visit Mini-Circuits' website at www.minicircuits.com/MCLStore/terms.jsp



Typical S-parameters, $V_{DS}=4V$ and $I_{DS}=30\text{ mA}$ (Fig. 3)

Freq. (GHz)	S11		S21			S12		S22		MSG/MAG (dB)
	Mag.	Ang.	Mag.	Mag (dB)	Ang.	Mag.	Ang.	Mag.	Ang.	
0.1	0.99	-16.62	23.16	27.30	169.5	0.009	79.4	0.61	-12.06	34.0
0.5	0.88	-73.31	18.36	25.28	132.5	0.036	52.2	0.49	-50.89	27.0
0.9	0.77	-111.77	13.51	22.61	108.3	0.049	37.1	0.36	-76.91	24.4
1.0	0.76	-119.67	12.58	21.99	103.5	0.051	33.7	0.34	-82.55	23.9
1.5	0.70	-149.65	9.17	19.25	84.3	0.058	24.1	0.25	-104.45	22.0
1.9	0.68	-167.34	7.47	17.47	72.1	0.062	19.2	0.21	-119.17	20.8
2.0	0.67	-171.13	7.14	17.07	69.3	0.063	18.4	0.20	-122.66	20.5
2.5	0.67	171.46	5.84	15.33	56.2	0.069	13.6	0.17	-139.21	19.3
3.0	0.66	156.41	4.93	13.86	44.0	0.074	9.0	0.14	-155.97	18.2
4.0	0.67	130.52	3.75	11.49	21.4	0.085	0.0	0.12	169.62	15.9
5.0	0.68	107.77	3.04	9.66	-0.1	0.098	-10.3	0.12	134.56	13.3
6.0	0.70	86.77	2.55	8.14	-20.9	0.111	-21.6	0.14	103.32	11.8
7.0	0.72	66.87	2.19	6.79	-41.6	0.123	-34.4	0.18	77.45	10.7
8.0	0.75	47.72	1.90	5.58	-61.9	0.135	-47.6	0.24	55.67	9.8
9.0	0.79	28.73	1.65	4.37	-82.2	0.144	-62.3	0.30	36.33	9.3
10.0	0.83	9.64	1.44	3.15	-102.6	0.15	-77.4	0.38	18.12	9.1
11.0	0.86	-8.92	1.24	1.89	-122.9	0.152	-93.0	0.45	0.90	9.1
12.0	0.89	-26.90	1.07	0.60	-142.8	0.151	-108.5	0.52	-15.63	8.5
13.0	0.91	-44.62	0.92	-0.73	-162.9	0.147	-124.8	0.58	-32.08	8.0
14.0	0.93	-61.40	0.78	-2.11	177.7	0.14	-140.4	0.64	-47.96	7.5
15.0	0.94	-74.24	0.67	-3.52	161.7	0.132	-153.4	0.69	-60.57	7.0
16.0	0.96	-84.49	0.56	-4.99	147.6	0.121	-163.2	0.74	-71.29	6.7
17.0	0.96	-95.82	0.48	-6.42	132.4	0.111	-174.6	0.77	-83.45	6.4
18.0	0.96	-107.81	0.40	-7.93	116.4	0.102	174.8	0.80	-96.97	5.9

MAXIMUM STABLE GAIN (MSG)/MAXIMUM AVAILABLE GAIN (MAG) vs. FREQUENCY

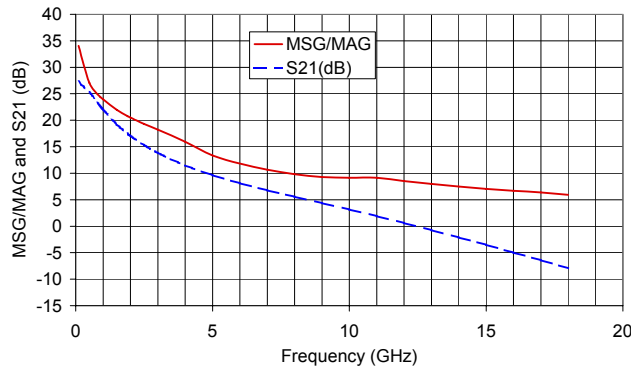

Typical Noise Parameters, $V_{DS}=4V$ and $I_{DS}=30\text{ mA}$ (Fig. 3)

Freq. (GHz)	F Min. (dB)	Γ Opt (Magnitude)	Γ Opt (Angle)	Rn/50	Ga
					Associated Gain (dB)
0.5	0.09	0.37	16.12	0.08	26.6
0.7	0.12	0.37	28.50	0.07	24.6
0.9	0.16	0.37	40.63	0.06	23.0
1.0	0.18	0.37	46.59	0.06	22.3
1.9	0.34	0.39	97.42	0.03	17.8
2.0	0.35	0.39	102.75	0.03	17.4
2.4	0.42	0.40	123.43	0.03	16.3
3.0	0.53	0.41	152.52	0.03	14.9
3.9	0.69	0.43	-168.14	0.05	13.3
5.0	0.89	0.45	-127.09	0.10	11.8
5.8	1.03	0.46	-102.09	0.16	10.8
6.0	1.06	0.47	-96.48	0.18	10.6

Notes:
 F Min.: Minimum Noise Figure
 Γ Opt: Optimum Source Reflection Coefficient
 Rn: Equivalent noise resistance

Notes

- A. Performance and quality attributes and conditions not expressly stated in this specification document are intended to be excluded and do not form a part of this specification document.
- B. Electrical specifications and performance data contained in this specification document are based on Mini-Circuit's applicable established test performance criteria and measurement instructions.
- C. The parts covered by this specification document are subject to Mini-Circuits standard limited warranty and terms and conditions (collectively, "Standard Terms"); Purchasers of this part are entitled to the rights and benefits contained therein. For a full statement of the Standard Terms and the exclusive rights and remedies thereunder, please visit Mini-Circuits' website at www.minicircuits.com/MCLStore/terms.jsp



Product Marking

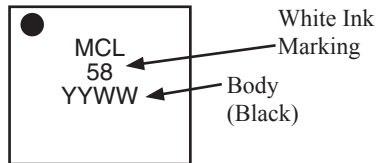

Additional Detailed Technical Information

Additional information is available on our web site www.minicircuits.com. To access this information enter the model number on our web site home page.

Performance data, graphs, s-parameter data set (.zip file)

Case Style: FG873

Plastic low profile 3mm x 3mm, lead finish: tin/silver/nickel

Suggested Layout for PCB Design: PL-301

Tape & Reel: F68

Characterization Test Board: TB-154+

Environmental Ratings: ENV08T2

ESD Rating

Human Body Model (HBM): Class 1A (250 V to < 500 V) in accordance with ANSI/ESD STM 5.1 - 2001

Machine Model (MM): Class M1 (40 V) in accordance with ANSI/ESD STM 5.2 - 1999

MSL Rating

Moisture Sensitivity: MSL1 in accordance with IPC/JEDECJ-STD-020D

MSL Test Flow Chart

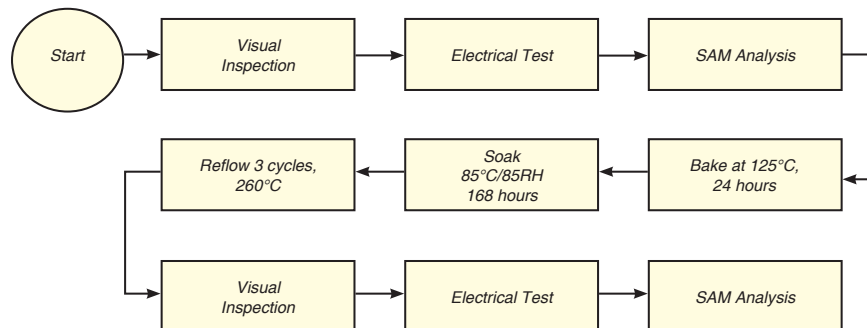

Notes

- Performance and quality attributes and conditions not expressly stated in this specification document are intended to be excluded and do not form a part of this specification document.
- Electrical specifications and performance data contained in this specification document are based on Mini-Circuit's applicable established test performance criteria and measurement instructions.
- The parts covered by this specification document are subject to Mini-Circuits standard limited warranty and terms and conditions (collectively, "Standard Terms"); Purchasers of this part are entitled to the rights and benefits contained therein. For a full statement of the Standard Terms and the exclusive rights and remedies thereunder, please visit Mini-Circuits' website at www.minicircuits.com/MCLStore/terms.jsp

Recommended Application Circuit

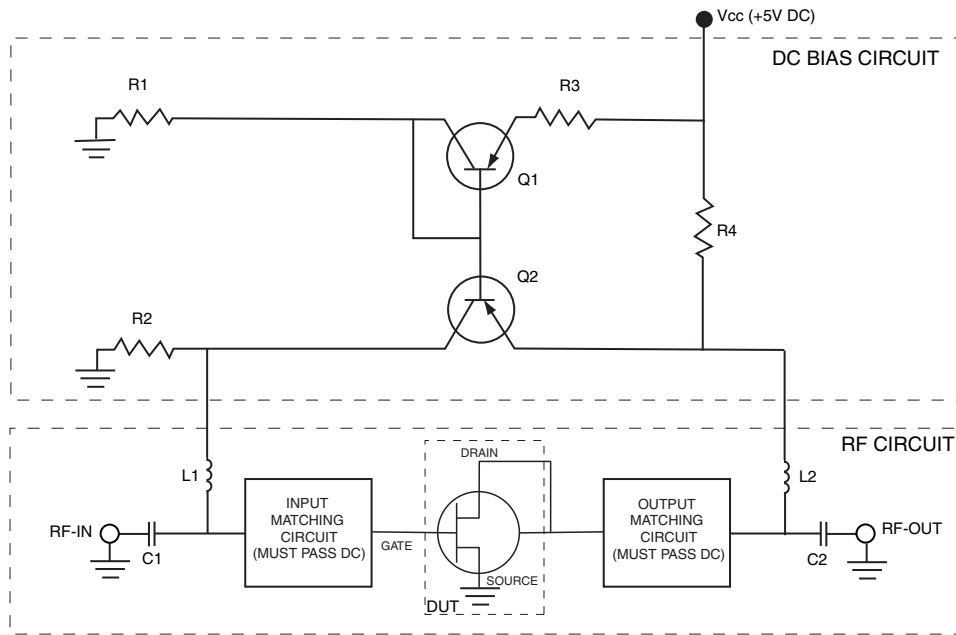

VDS, V (nom)	3	4
IDS, mA (nom)	30mA	30mA
R1	4320Ω	4320Ω
R2	4320Ω	4320Ω
R3	3570Ω	1210Ω
R4	68.1Ω	33.2Ω
Q1	MMBT3906*	MMBT3906*
Q2	MMBT3906*	MMBT3906*
C1	0.01μF	0.01μF
C2	0.01μF	0.01μF
L1**	840nH	840nH
L2**	840nH	840nH

* Fairchild Semiconductor™ part number
 ** Piconics™ part number CC45T47K240G5

Optimized Amplifier Circuits

For band specific, drop-in modules, and as an alternative to designing circuits, please refer to Mini-Circuits TAMP and RAMP series models which are based upon SAV/TAV E-PHEMT's and include all DC blocking, bias, matching and stabilization circuitry, without need for any external components.

Notes

- A. Performance and quality attributes and conditions not expressly stated in this specification document are intended to be excluded and do not form a part of this specification document.
- B. Electrical specifications and performance data contained in this specification document are based on Mini-Circuits' applicable established test performance criteria and measurement instructions.
- C. The parts covered by this specification document are subject to Mini-Circuits standard limited warranty and terms and conditions (collectively, "Standard Terms"); Purchasers of this part are entitled to the rights and benefits contained therein. For a full statement of the Standard Terms and the exclusive rights and remedies thereunder, please visit Mini-Circuits' website at www.minicircuits.com/MCLStore/terms.jsp

