

### Applications

- Commercial and Military Radar
- Satellite Communications

### Product Features

- Frequency Range: 16 - 18 GHz
- Psat: 30.5 dBm at Pin = 10 dBm
- PAE: 28 % at Pin = 10 dBm
- Small Signal Gain: 26.5 dB
- Input Return Loss: > 13 dB
- Bias:  $V_D = 6\text{ V}$ ,  $I_{DQ} = 400\text{ mA}$ ,  $V_G = -0.6\text{ V}$  Typical
- Chip Dimensions: 2.0 x 2.5 x 0.1 mm

### General Description

TriQuint's TGA2621 is a Ku-band Power Amplifier fabricated on TriQuint's TQPHT15 0.15  $\mu\text{m}$  GaAs pHEMT process. The TGA2621 operates from 16 to 18 GHz and typically provides 1 W of saturated output power with an efficiency of 28% PAE and 26.5 dB of small signal gain.

The TGA2621 is well suited to support both radar and satellite communications as a driver or low power amplifier.

Both RF ports have intergrated DC blocking caps and are fully matched to 50 ohms allowing for simple system integration.

Lead-free and RoHS compliant

Evaluation Boards are available upon request.

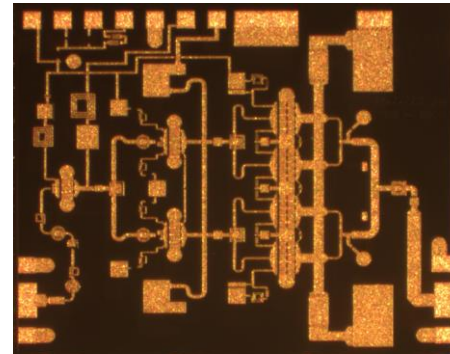

### Functional Block Diagram

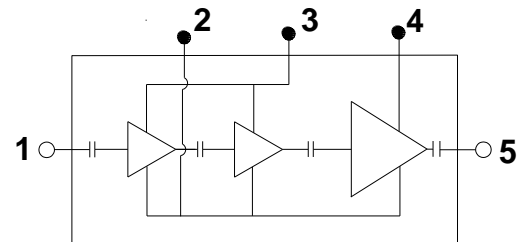

### Pad Configuration

Pad No.	Symbol
1	RF <sub>IN</sub>
2	V <sub>G</sub>
3	V <sub>D1</sub>
4	V <sub>D2</sub>
5	RF <sub>OUT</sub>

### Ordering Information

Part	ECCN	Description
TGA2621	EAR99	16 - 18 GHz GaAs PA

### Absolute Maximum Ratings

Parameter	Value
Drain Voltage ( $V_D$ )	6.25 V
Gate Voltage Range ( $V_G$ )	-2 to 0 V
Drain Current ( $I_D$ )	1300 mA
Gate Current ( $I_G$ )	-5 to 5 mA
Power Dissipation, 85 °C ( $P_{DISS}$ )	3.8 W
Input Power, CW, 50 $\Omega$ , ( $P_{IN}$ )	17 dBm
Channel temperature ( $T_{CH}$ )	200 °C
Mounting Temperature (30 Seconds)	320 °C
Storage Temperature	-55 to 150 °C

Operation of this device outside the parameter ranges given above may cause permanent damage. These are stress ratings only, and functional operation of the device at these conditions is not implied.

### Recommended Operating Conditions

Parameter	Value
Drain Voltage ( $V_D$ )	6 V
Drain Current ( $I_{DQ}$ )	400 mA
Gate Voltage ( $V_G$ )	-0.6 V Typical
Temperature ( $T_{BASE}$ )	-40 to 85 °C

Electrical specifications are measured at specified test conditions. Specifications are not guaranteed overall operating conditions.

### Electrical Specifications

Test conditions unless otherwise noted: 25 °C,  $V_D = 6$  V,  $I_{DQ} = 400$  mA,  $V_G = -0.6$  V Typical, CW

Parameter	Min	Typical	Max	Units
Operational Frequency Range	16		18	GHz
Small Signal Gain		26.5		dB
Input Return Loss		> 13		dB
Output Return Loss		> 6		dB
Output Power ( $P_{in} = 10$ dBm)		30.5		dBm
Power Added Efficiency ( $P_{in} = 10$ dBm)		28		%
IM3 ( $P_{out}/tone = 20$ dBm, spacing = 10 MHz)		-25.5		dBc
IM5 ( $P_{out}/tone = 20$ dBm, spacing = 10 MHz)		-46.5		dBc
Small Signal Gain Temperature Coefficient		-0.03		dB/°C
Output Power Temperature Coefficient		-0.02		dBm/°C

### Thermal and Reliability Information

Parameter	Test Conditions	Value	Units
Thermal Resistance ( $\theta_{JC}$ ) <sup>(1)</sup>	$T_{base} = 85\text{ }^{\circ}\text{C}$ , $V_D = 6\text{ V (CW)}$ $I_{DQ} = 400\text{ mA}$ , $P_{DISS} = 2.4\text{ W}$	26	$^{\circ}\text{C/W}$
Channel Temperature ( $T_{CH}$ ) (Without RF)		147	$^{\circ}\text{C}$
Median Lifetime ( $T_M$ )		$1.5 \times 10^6$	Hrs
Thermal Resistance ( $\theta_{JC}$ ) <sup>(1)</sup>	$T_{base} = 85\text{ }^{\circ}\text{C}$ , $V_D = 6\text{ V (CW)}$ $I_{DQ} = 400\text{ mA}$ , $I_{D\_Drive} = 617\text{ mA}$ $P_{IN} = 10\text{ dBm}$ , $P_{OUT} = 30\text{ dBm}$ , $Freq = 17\text{ GHz}$ , $P_{DISS} = 2.7\text{ W}$	26.1	$^{\circ}\text{C/W}$
Channel Temperature ( $T_{CH}$ ) (Under RF drive)		150	$^{\circ}\text{C}$
Median Lifetime ( $T_M$ )		$1.0 \times 10^6$	Hrs

Notes:

1. Thermal resistance calculated at back of a 40 mil CuMo carrier plate with 1.5 mil of AuSn solder for die attach.

Test Conditions:  $V_D = 6\text{ V}$ ; Failure Criteria is 10% reduction in  $I_{D\_MAX}$

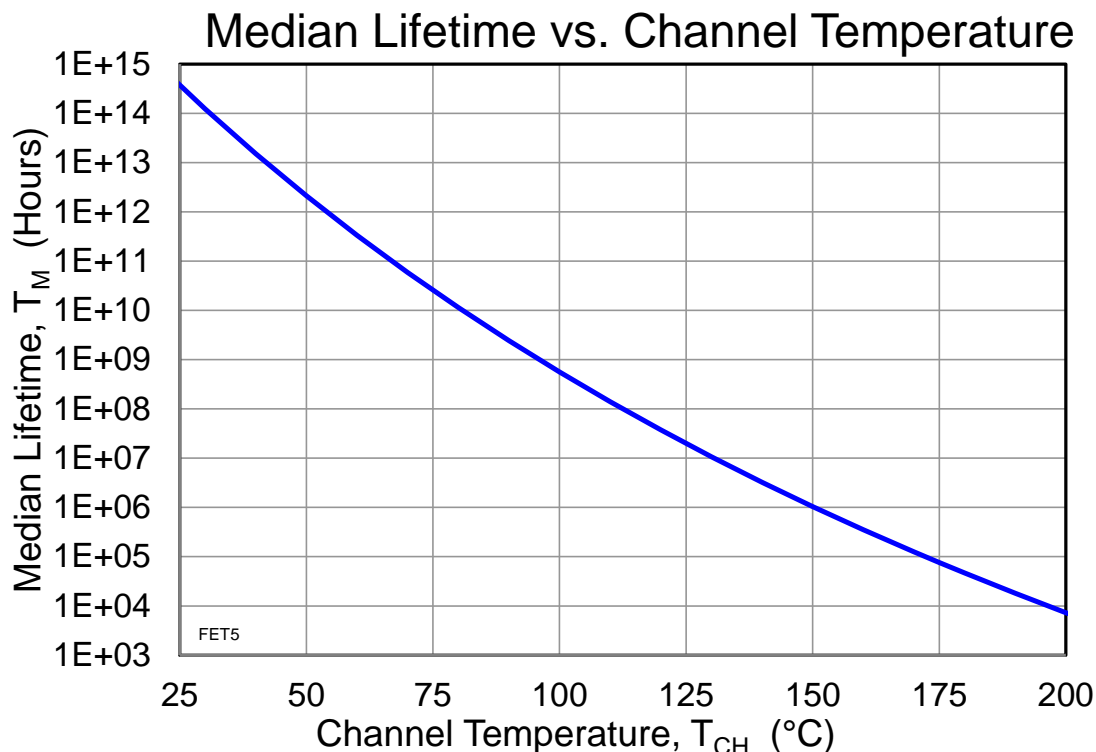

### Typical Performance: Small Signal

Conditions unless otherwise specified:  $V_D = 6\text{ V}$ ,  $I_{DQ} = 400\text{ mA}$ ,  $V_G = -0.6\text{ V}$  Typical, CW

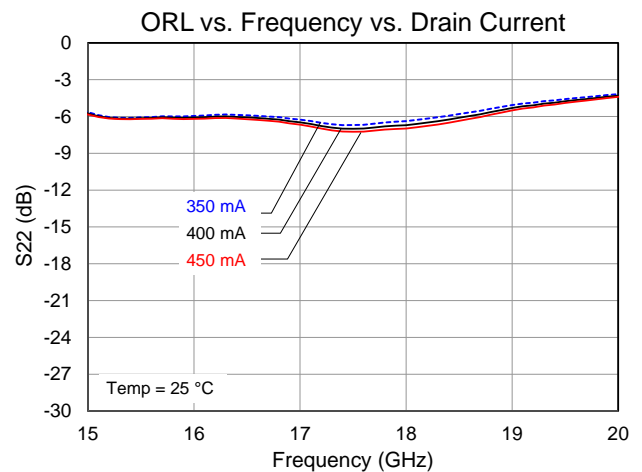
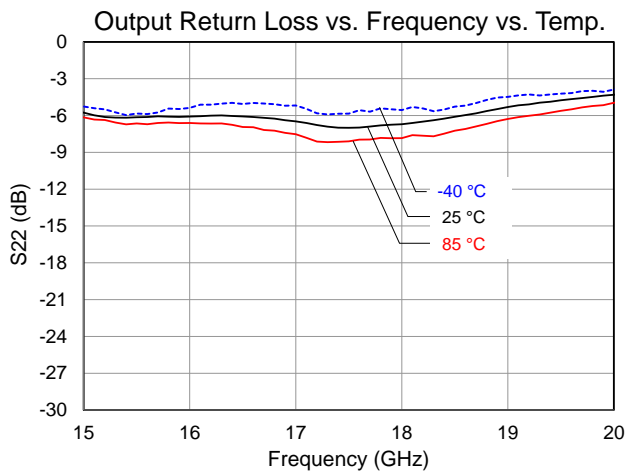
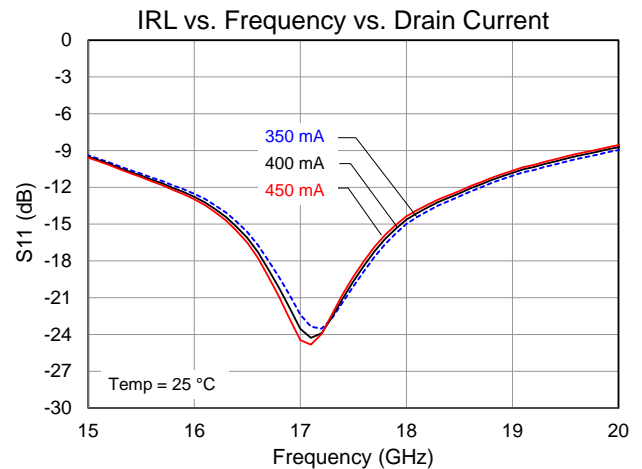
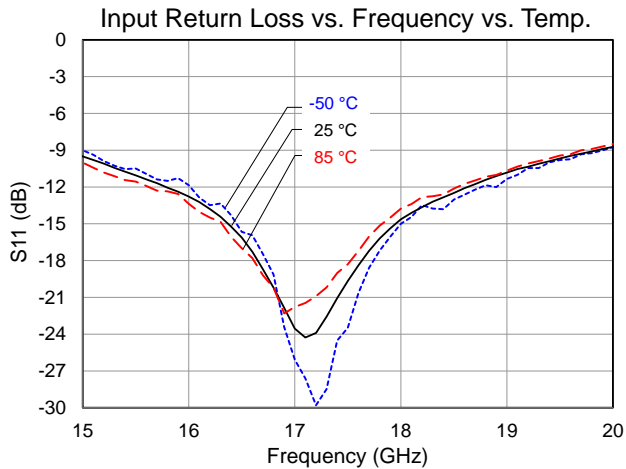
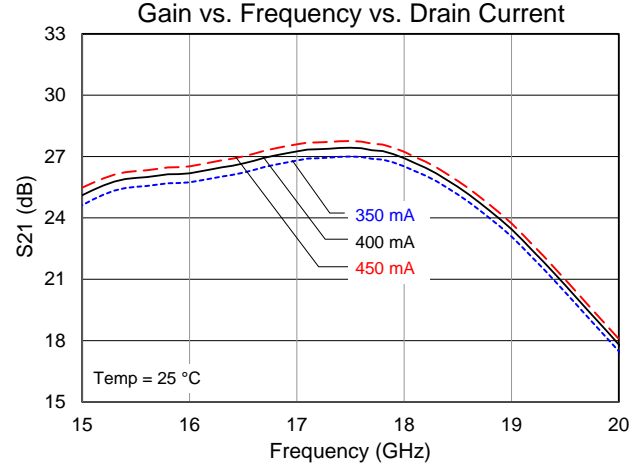
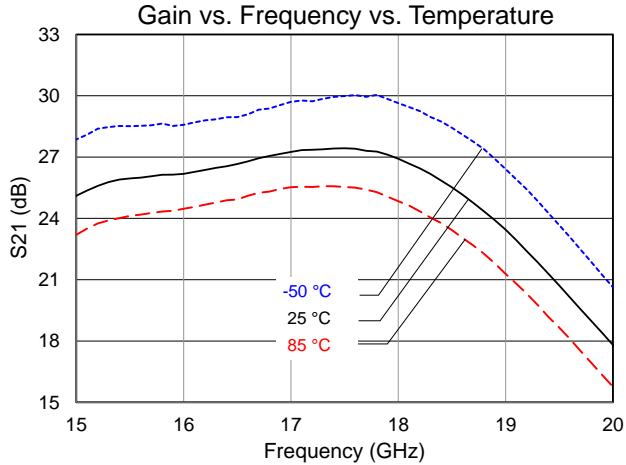

### Typical Performance: Large Signal

Conditions unless otherwise specified:  $V_D = 6\text{ V}$ ,  $I_{DQ} = 400\text{ mA}$ ,  $V_G = -0.6\text{ V}$  Typical, CW

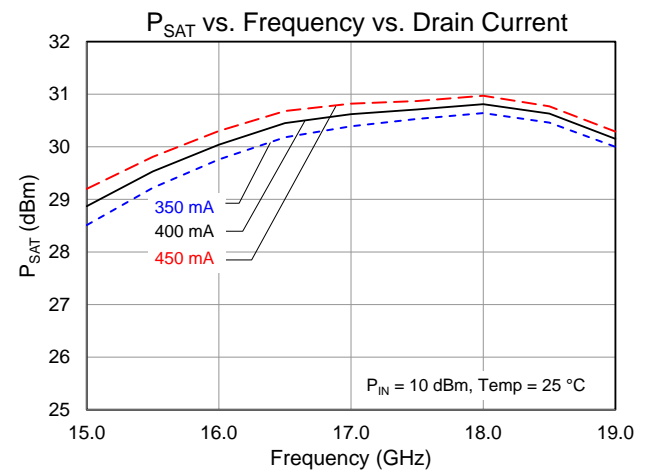
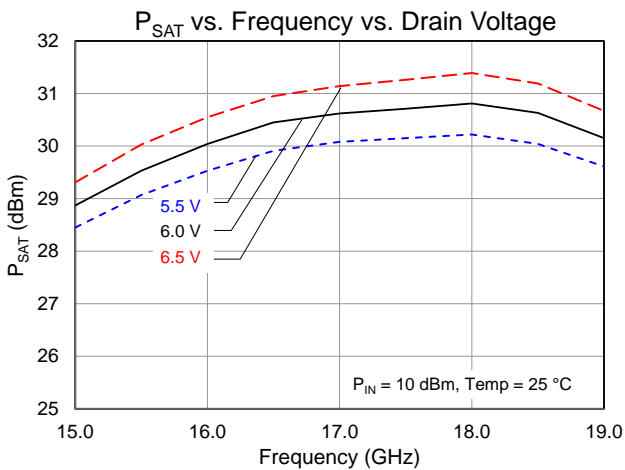
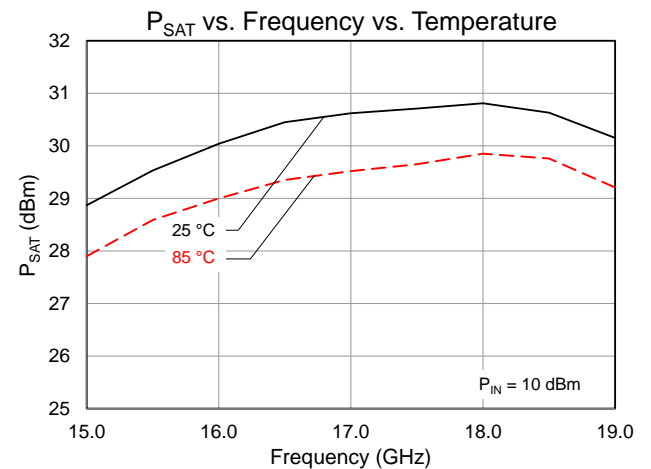
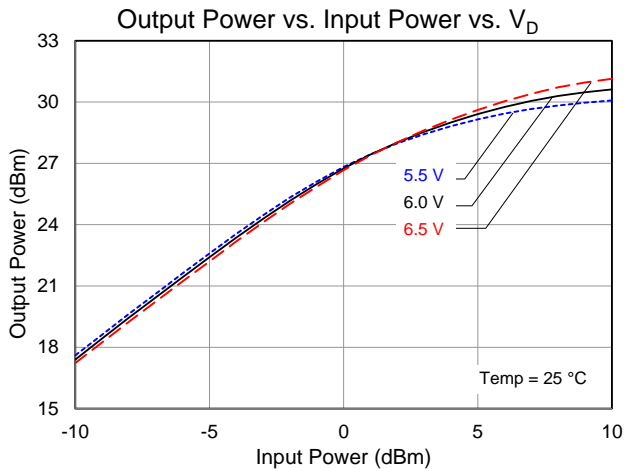
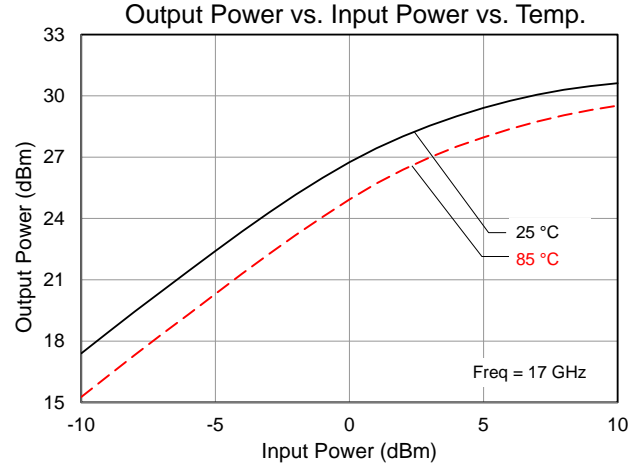
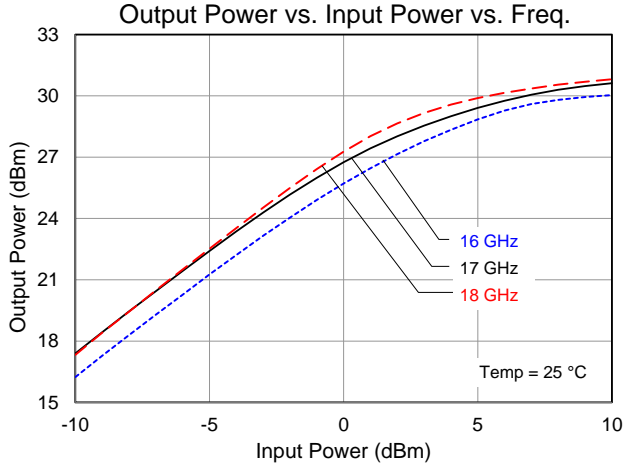

### Typical Performance: Large Signal

Conditions unless otherwise specified:  $V_D = 6\text{ V}$ ,  $I_{DQ} = 400\text{ mA}$ ,  $V_G = -0.6\text{ V}$  Typical, CW

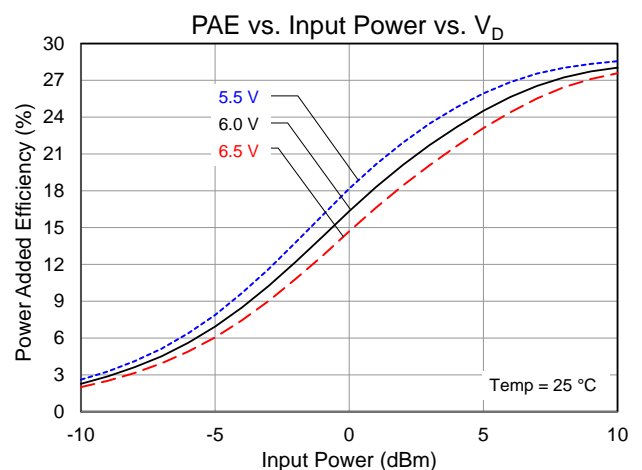
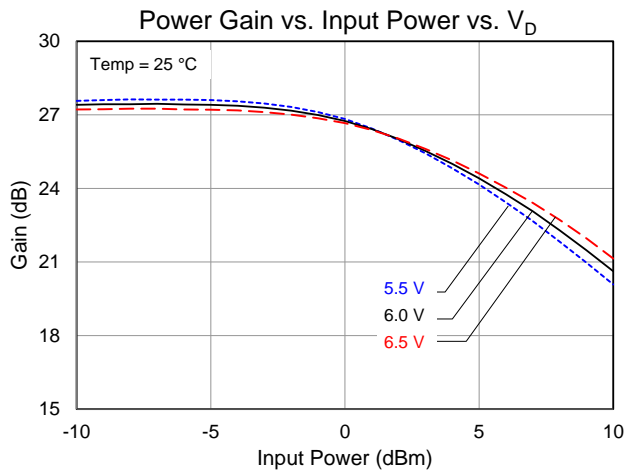
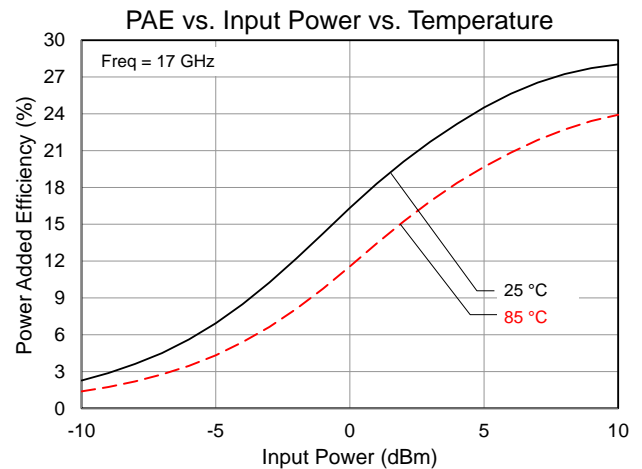
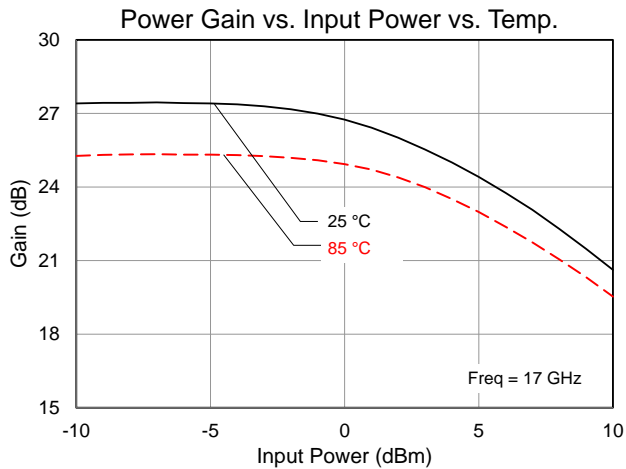
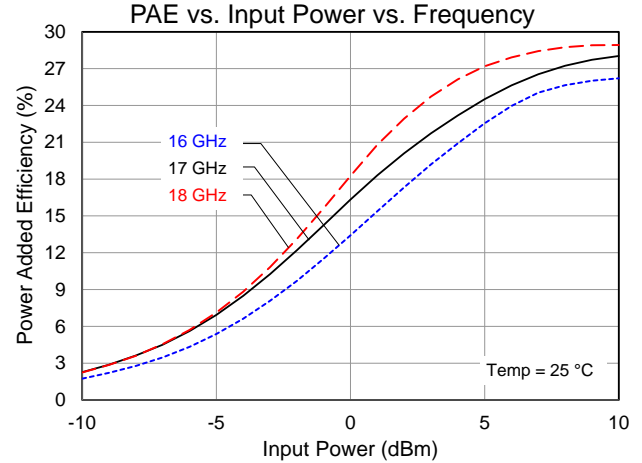
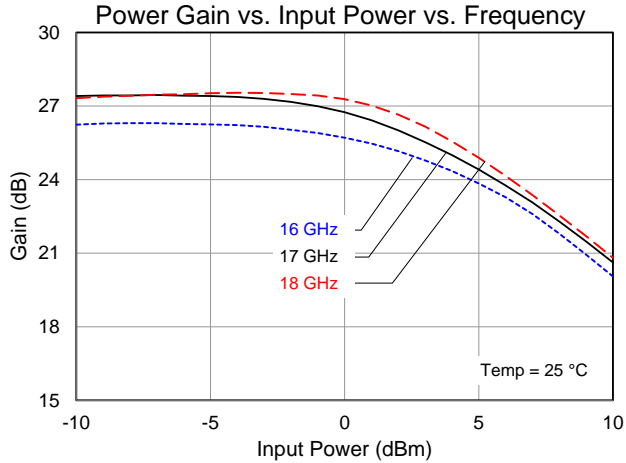

### Typical Performance: Large Signal

Conditions unless otherwise specified:  $V_D = 6\text{ V}$ ,  $I_{DQ} = 400\text{ mA}$ ,  $V_G = -0.6\text{ V}$  Typical, CW

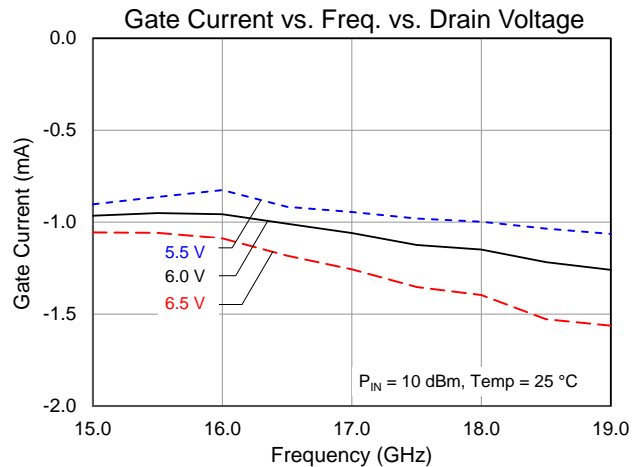
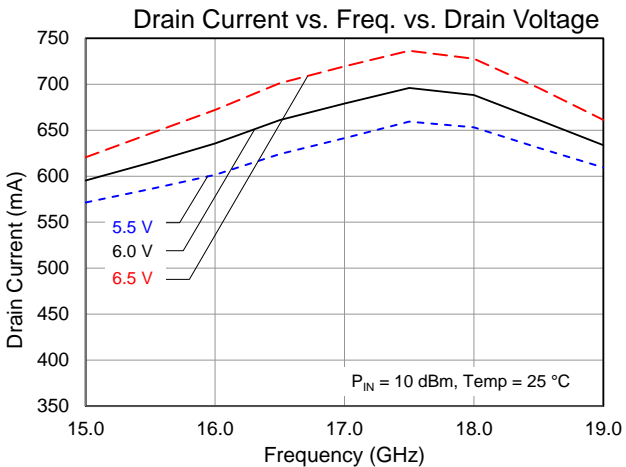
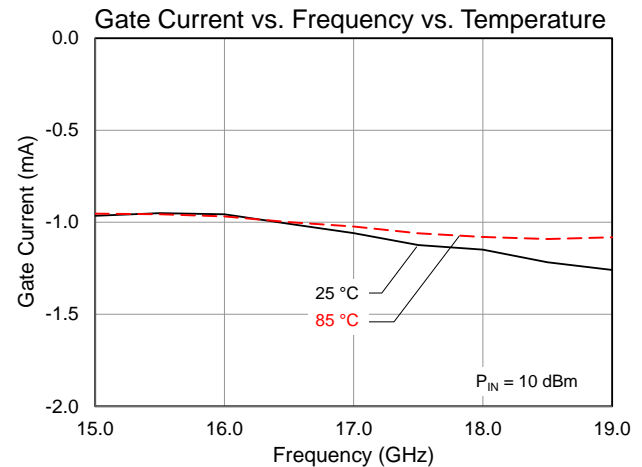
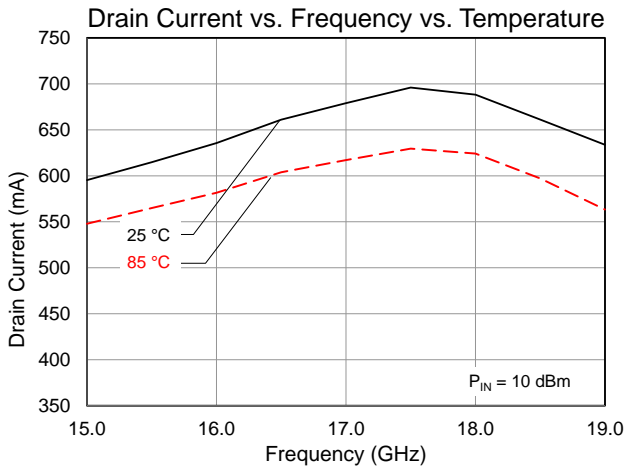
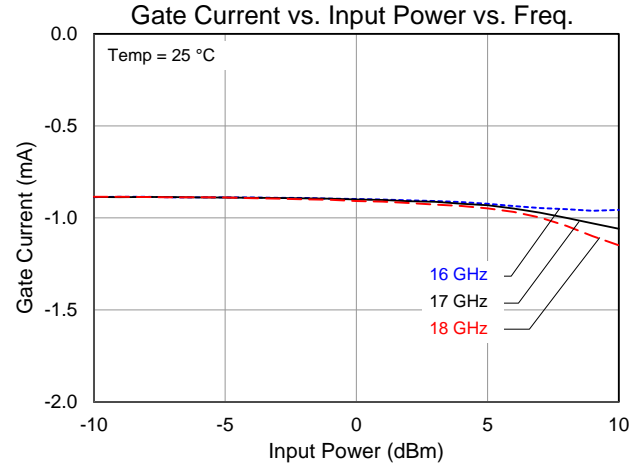
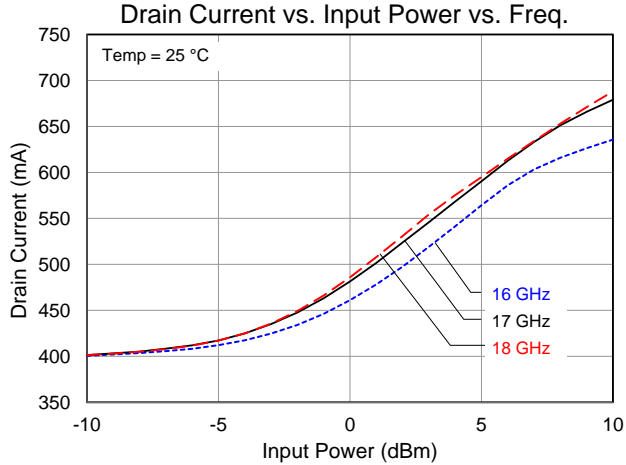

### Typical Performance: Linearity

Conditions unless otherwise specified:  $V_D = 6\text{ V}$ ,  $I_{DQ} = 400\text{ mA}$ ,  $V_G = -0.6\text{ V}$  Typical, CW

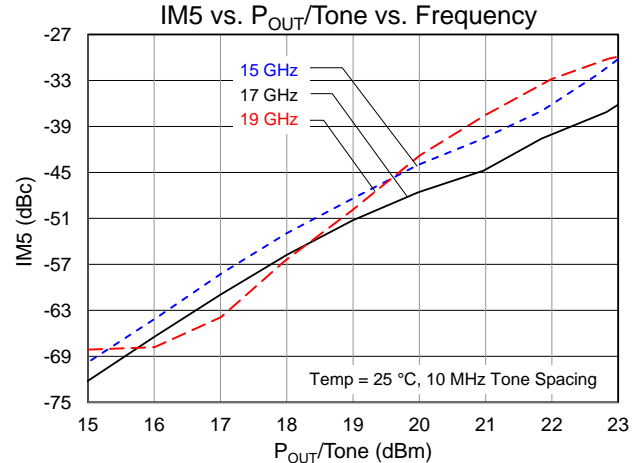
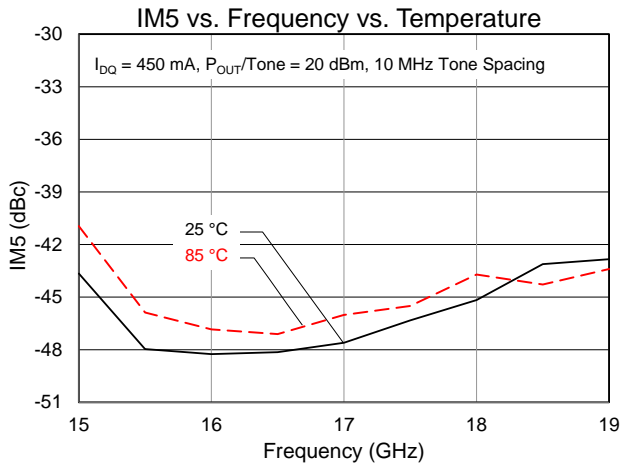
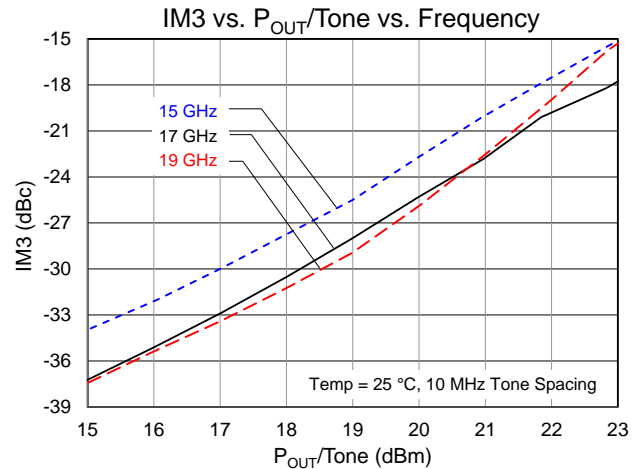
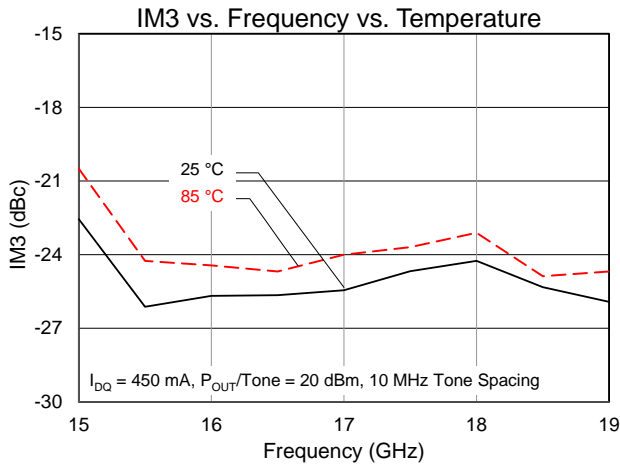
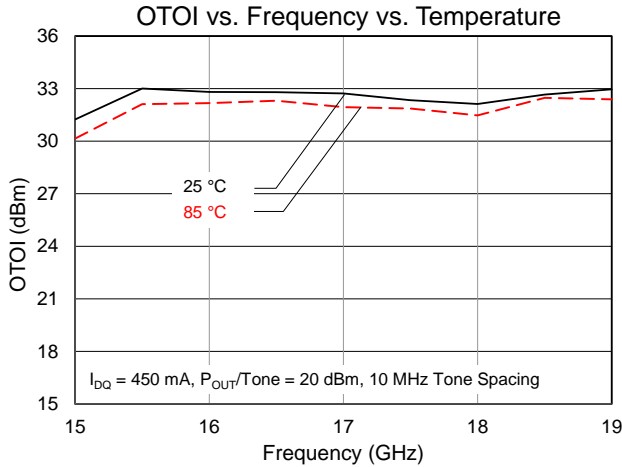



**Application Information**

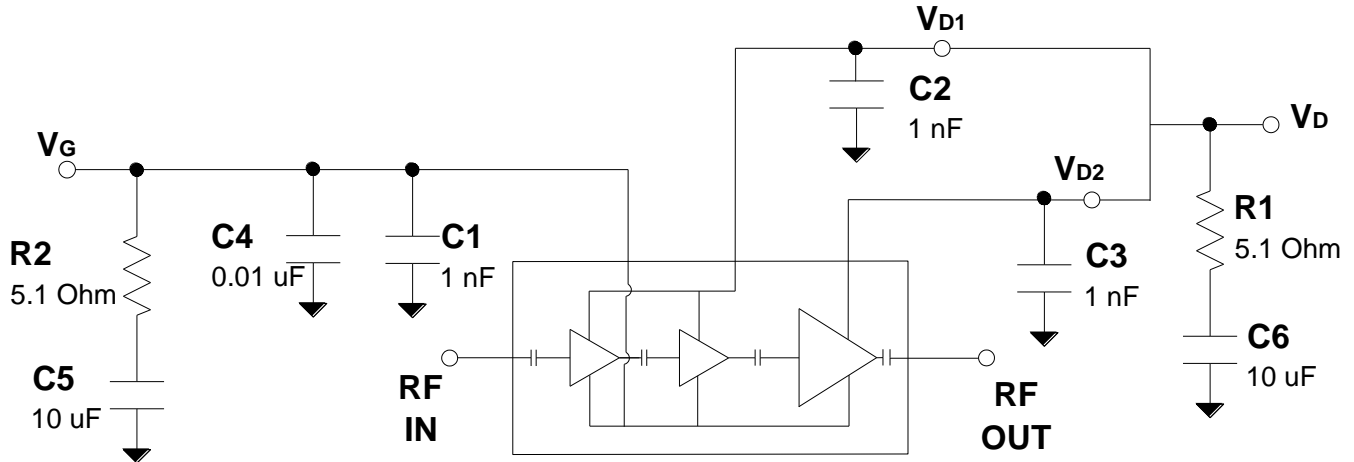

**Bias-up Procedure**

1. Set  $I_D$  limit to 1 A,  $I_G$  limit to 4 mA
2. Apply -2 V to  $V_G$  for pinch off
3. Apply 6 V to  $V_D$
4. Adjust  $V_G$  more positive until  $I_{DQ} = 400$  mA ( $V_G \sim -0.6$  V Typical)
5. Apply RF signal

**Bias-down Procedure**

1. Turn off RF signal
2. Reduce  $V_G$  to -2V. Ensure  $I_{DQ} \sim 0$ mA
3. Set  $V_D$  to 0V
4. Turn off  $V_D$  supply
5. Turn off  $V_G$  supply

**Assembly Drawing**

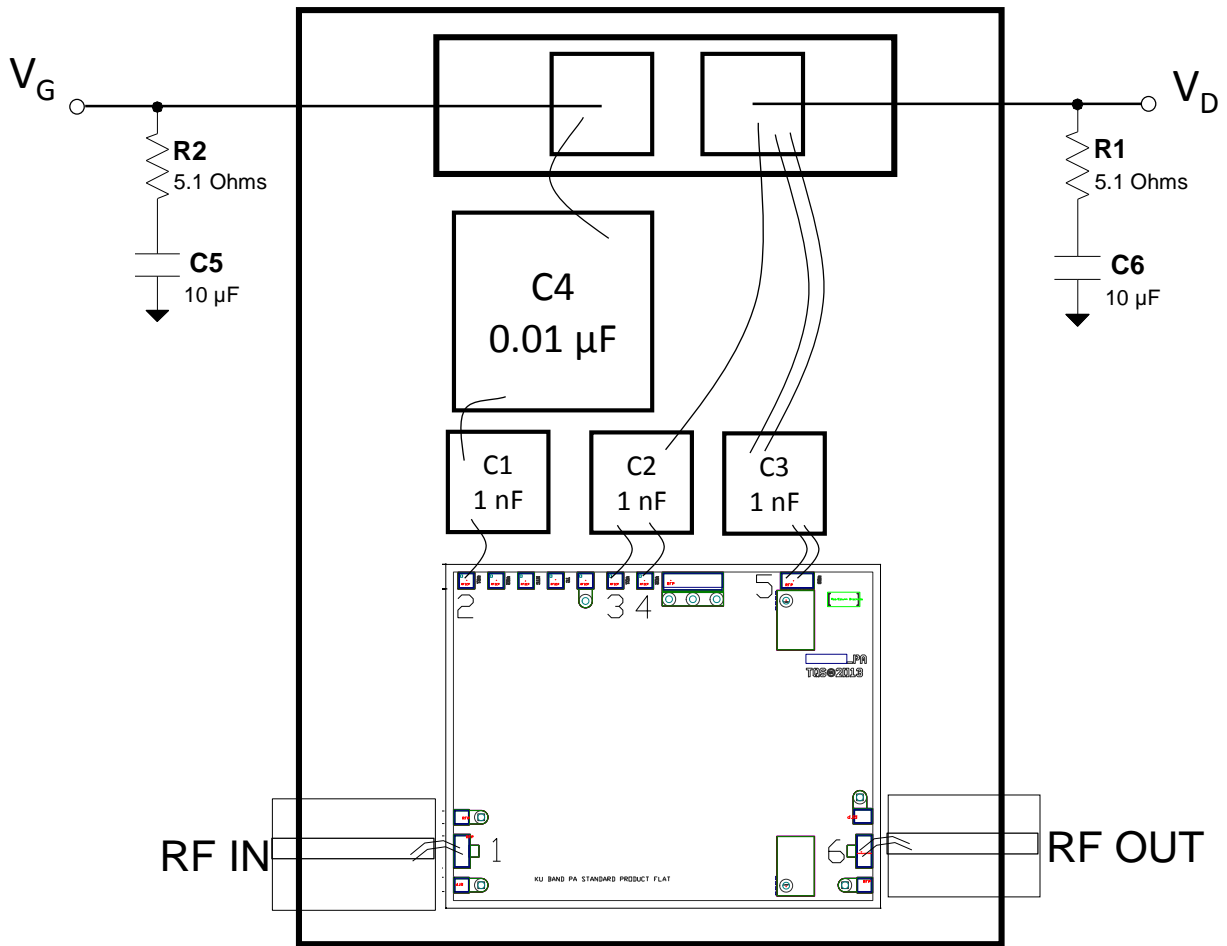

**Bill of Material**

Reference Des.	Value	Description	Manuf.	Part Number
C1, C2, C3	1 nF	Capacitor, 50 V, SLC	Various	
C4	0.01 μF	Capacitor, 0402, 50 V, MLCC	Various	
C5	10 μF	Capacitor, 0805, 50 V, MLCC	Various	
C6	10 μF	Capacitor, 0805, 25 V, MLCC	Various	
R1, R2	5.1 Ohms	Resistor, 0402, SMD	Various	

## Mechanical Information

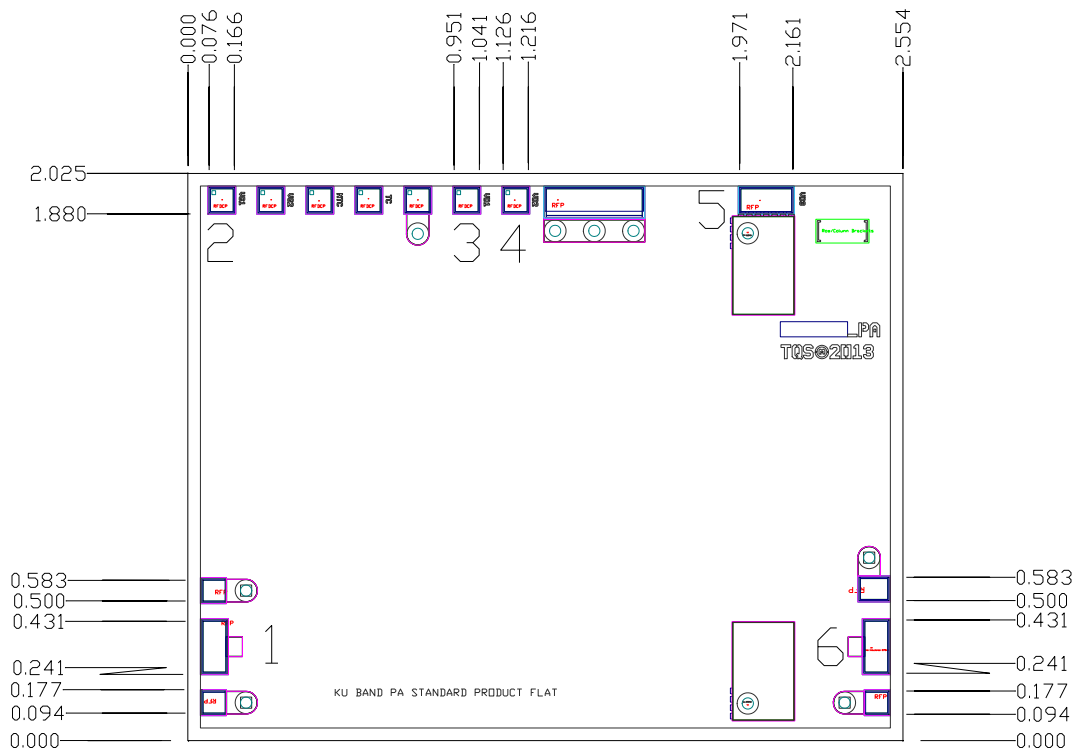

Units: millimeters  
 Thickness: 0.10  
 Die x,y size tolerance:  $\pm 0.050$   
 Ground is backside of die  
 RF<sub>IN</sub> and RF<sub>OUT</sub> pads are symmetric

## Pad Description

Pad No.	Symbol	Description	Pad Size
1	RF <sub>IN</sub>	Input; matched to 50 Ω; DC blocked	0.1 x 0.2 mm
2	V <sub>G</sub>	Gate voltage; bias network is required; see recommended Application	0.1 x 0.1 mm
3,4	V <sub>D1</sub> (1)	Drain voltage; bias network is required; see recommended Application	0.1 x 0.1 mm
5	V <sub>D2</sub> (1)	Drain voltage; bias network is required; see recommended Application	0.2 x 0.1 mm
6	RF <sub>OUT</sub>	Output; matched to 50 Ω; DC blocked	0.1 x 0.2 mm

Notes:  
 1. Pads 3,4, & 5 may be tied together off-chip.

## Assembly Notes

Component placement and adhesive attachment assembly notes:

- Vacuum pencils and/or vacuum collets are the preferred method of pick up.
- Air bridges must be avoided during placement.
- The force impact is critical during auto placement.
- Organic attachment (i.e. epoxy) can be used in low-power applications.
- Curing should be done in a convection oven; proper exhaust is a safety concern.

Solder attachment reflow process assembly notes:

- Use AuSn (80/20) solder and limit exposure to temperatures above 300°C to 3 to 4 minutes, maximum.
- An alloy station or conveyor furnace with reducing atmosphere should be used.
- Do not use any kind of flux.
- Coefficient of thermal expansion matching is critical for long-term reliability.
- Devices must be stored in a dry nitrogen atmosphere.

Organic adhesive attachment assembly notes:

- Organic adhesives such as ABLEBOND 84-1, or equivalent, can be used.
- Epoxies cure at temperatures of 100 to 200°C.

Interconnect process assembly notes:

- Thermosonic ball bonding is the preferred interconnect technique.
- Force, time, and ultrasonics are critical parameters.
- Aluminum wire should not be used.
- Devices with small pad sizes should be bonded with 0.0007-inch wire.

## Product Compliance Information

### ESD Sensitivity Ratings



Caution! ESD-Sensitive Device

ESD Rating: TBD  
Value: TBD  
Test: Human Body Model (HBM)  
Standard: JEDEC Standard JESD22-A114

### ECCN

US Department of Commerce: EAR99

### Solderability

Use only AuSn (80/20) solder and limit exposure to temperatures above 300 °C to 3-4 minutes, maximum.

### RoHS-Compliance

This part is compliant with EU 2002/95/EC RoHS directive (Restrictions on the Use of Certain Hazardous Substances in Electrical and Electronic Equipment).

This product also has the following attributes:

- Lead Free
- Halogen Free (Chlorine, Bromine)
- Antimony Free
- TBBP-A (C<sub>15</sub>H<sub>12</sub>Br<sub>4</sub>O<sub>2</sub>) Free
- PFOS Free
- SVHC Free

## Contact Information

For the latest specifications, additional product information, worldwide sales and distribution locations, and information about TriQuint:

Web: [www.triquint.com](http://www.triquint.com)  
Email: [info-sales@triquint.com](mailto:info-sales@triquint.com)

Tel: +1.972.994.8465  
Fax: +1.972.994.8504

For technical questions and application information: Email: [info-products@triquint.com](mailto:info-products@triquint.com)

## Important Notice

The information contained herein is believed to be reliable. TriQuint makes no warranties regarding the information contained herein. TriQuint assumes no responsibility or liability whatsoever for any of the information contained herein. TriQuint assumes no responsibility or liability whatsoever for the use of the information contained herein. The information contained herein is provided "AS IS, WHERE IS" and with all faults, and the entire risk associated with such information is entirely with the user. All information contained herein is subject to change without notice. Customers should obtain and verify the latest relevant information before placing orders for TriQuint products. The information contained herein or any use of such information does not grant, explicitly or implicitly, to any party any patent rights, licenses, or any other intellectual property rights, whether with regard to such information itself or anything described by such information.

TriQuint products are not warranted or authorized for use as critical components in medical, life-saving, or life-sustaining applications, or other applications where a failure would reasonably be expected to cause severe personal injury or death.