

- Low-loss SAW Filter for Wimax Application
- 3.0 x 3.0mm Surface Mount Case
- 50Ω Input/Output Impedance

Absolute Maximum Ratings

Rating	Value	Units
Input Power Level	+15	dBm
DC Voltage on any Non-ground Terminal	3	V
Operating Temperature Range	-40 to +95	°C
Storage Temperature Range in Tape and Reel	-40 to +85	°C
Suitable for Lead-free Soldering - Maximum Soldering Profile	260 °C for 30 s	

SF2126E

**725.00 MHz
SAW Filter**

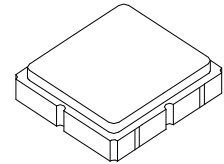

SM3030-8

Electrical Characteristics

Characteristic	Sym	Notes	Min (-40 to 95°C)	Typ	Max (-30 to 85°C)	Max (-40 to 95°C)	Units
Nominal Center Frequency	f _C			725			MHz
Frequency Range			700			750	MHz
Insertion Loss	IL			2.6	3.0	4.0	dB
Amplitude Ripple, p-p, 700 to 750 MHz				1	1.5	1.8	
VSWR					2.2	2.5	
Attenuation Referenced to 0 dB:							
500 to 600 MHz			40				
601 to 650 MHz			30				
651 to 665 MHz			20				
780 to 824 MHz			15				
825 to 844 MHz			30				
845 to 960 MHz			40				
Source Impedance	Z _S			50			Ω
Load Impedance	Z _L			50			Ω

Case Style	SM3030-8 3.0 x 3.0 mm Nominal Footprint
Lid Symbolization, Y=year, WW=week, S=shift, dot=pin 1 indicator	648, YWWS
Standard Reel Quantity Reel Size 7 Inch	500 Pieces/Reel

Electrical Connections

Connection	Terminals
Port 1	Input 1
Port 2	Output 5
	Ground All Others

Dot Indicates Pin 1

 **CAUTION: Electrostatic Sensitive Device. Observe precautions for handling.**

NOTES:

1. Unless noted otherwise, all specifications apply over the operating temperature range with filter soldered to the specified demonstration board with impedance matching to 50 Ω and measured with 50 Ω network analyzer.
2. Unless noted otherwise, all frequency specifications are referenced to the nominal center frequency, f_C.
3. The design, manufacturing process, and specifications of this filter are subject to change.
4. US and international patents may apply.
5. Murata, stylized Murata logo, and Murata N.A., Inc. are registered trademarks of Murata Manufacturing Co., Ltd.

Frequency Characteristics:

15 May 2007 07:31:11

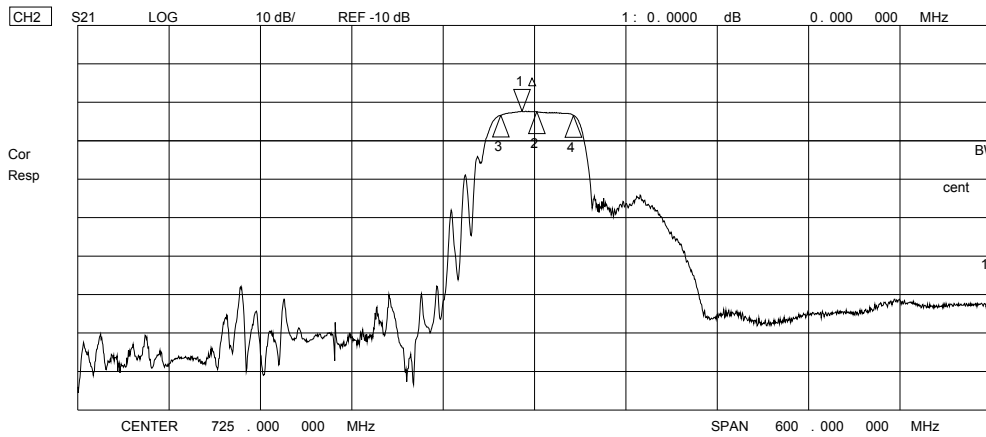
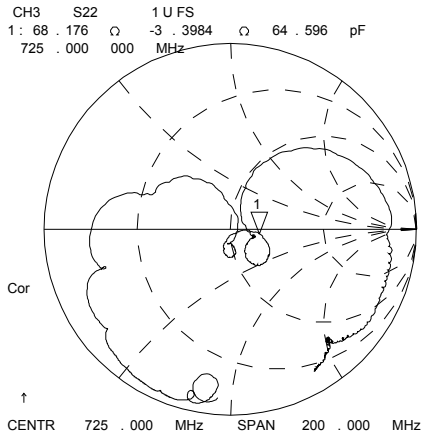
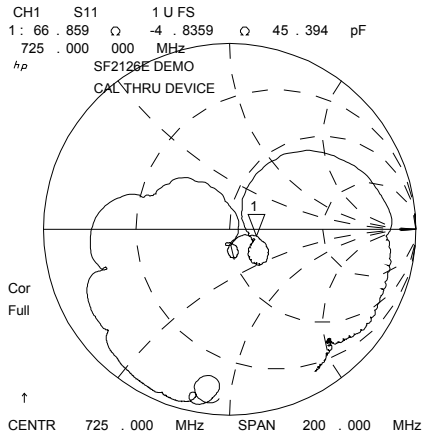

8-Terminal Ceramic Surface-Mount Case 3.0 X 3.0 mm Nominal Footprint

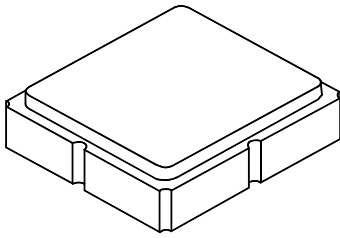

Case and PCB Footprint Dimensions

Dimension	mm			Inches		
	Min	Nom	Max	Min	Nom	Max
A	2.87	3.0	3.13	0.113	0.118	0.123
B	2.87	3.0	3.13	0.113	0.118	0.123
C	1.14	1.27	1.40	0.045	0.050	0.055
D	0.79	0.92	1.05	0.031	0.036	0.041
E	0.62	0.75	0.88	0.024	0.029	0.034
F	0.47	0.60	0.73	0.018	0.024	0.029
G	0.47	0.60	0.73	0.018	0.024	0.029
H	1.07	1.20	1.33	0.042	0.047	0.052
I		3.19			0.126	
J		0.81			0.032	
K		0.96			0.038	
L		0.81			0.032	
M		1.39			0.055	
N		0.23			0.009	
O		0.38			0.015	

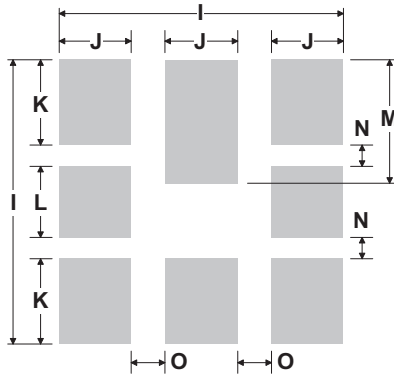

PCB Footprint Top View

Case Materials

Materials	
Solder Pad Plating	0.3 to 1.0 μm Gold over 1.27 to 8.89 μm Nickel
Lid Plating	2.0 to 3.0 μm Nickel
Body	Al_2O_3 Ceramic
Pb Free	

TOP VIEW

BOTTOM VIEW

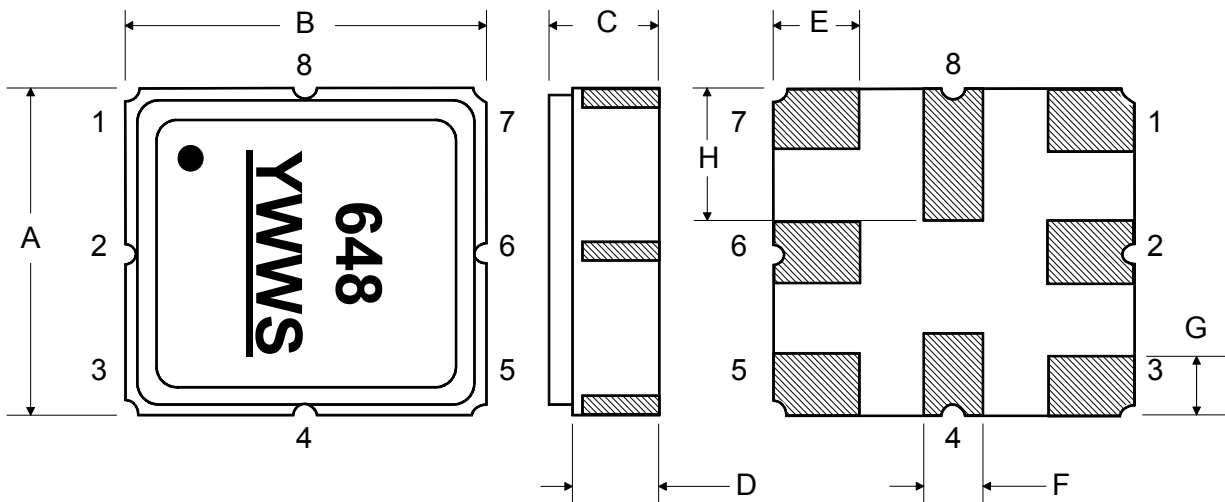

Tape and Reel Specifications

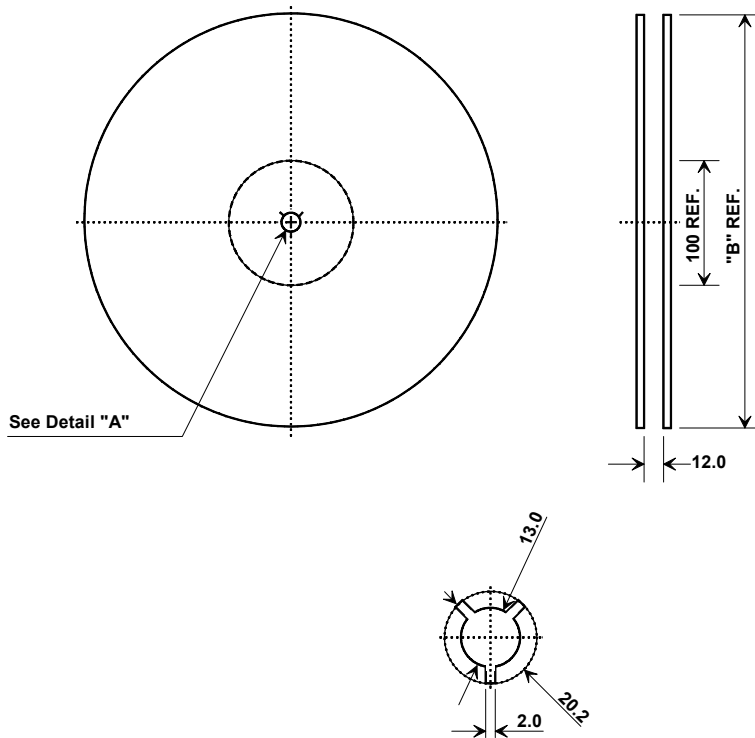

"B"		Quantity Per Reel
Inches	millimeters	
7	178	500
13	330	3000

COMPONENT ORIENTATION and DIMENSIONS

Carrier Tape Dimensions	
Ao	3.35 mm
Bo	3.35 mm
Ko	1.40 mm
Pitch	8.0 mm
W	12.0 mm

