

GaAs pHEMT MMIC 2 WATT POWER AMPLIFIER, 0.1 - 20 GHz

Typical Applications

The HMC998ALP5E is ideal for:

- Test Instrumentation
- Microwave Radio & VSAT
- Military & Space
- Telecom Infrastructure
- Fiber Optics

Features

- P1dB Output Power: +31 dBm
- Psat Output Power: +33 dBm
- High Gain: 11 dB
- Output IP3: +41 dBm
- Supply Voltage: Vdd = +15V @ 500 mA
- 50 Ohm Matched Input/Output
- 32 Lead 5x5 mm SMT Package: 25 mm²

Functional Diagram

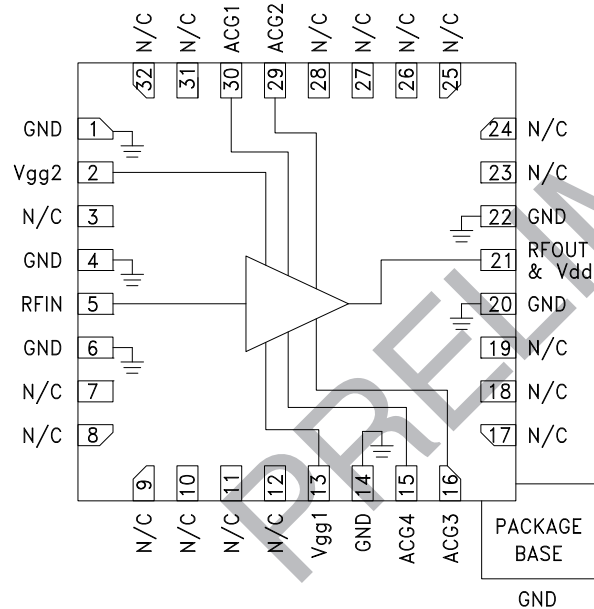

General Description

The HMC998ALP5E is a GaAs pHEMT MMIC Distributed Power Amplifier which operates between 0.1 and 20 GHz. The amplifier provides 11 dB of gain, +41 dBm output IP3, and +31 dBm of output power at 1 dB gain compression while requiring only 500 mA from a +15V supply. The HMC998ALP5E exhibits a slightly positive gain from 3 to 17 GHz making it ideal for EW, ECM, Radar and test equipment applications. The HMC998ALP5E amplifier I/Os are internally matched to 50 Ohms and is supplied in a leadless QFN 5x5 mm surface mount package.

Electrical Specifications, $T_A = +25^\circ\text{C}$, $V_{dd} = +15\text{V}$, $V_{gg2} = +9.5\text{V}$, $I_{dd} = 500\text{ mA}$ [1]

Parameter	Min.	Typ.	Max.	Min.	Typ.	Max.	Min.	Typ.	max	Units
Frequency Range	0.1 - 4			4 - 16			16 - 20			GHz
Gain	8	11		8	11		9	12		dB
Gain Flatness		±0.3			±0.5			±0.5		dB
Gain Variation Over Temperature		0.006			0.012			0.017		dB/°C
Input Return Loss		17			15			25		dB
Output Return Loss		10			15			20		dB
Output Power for 1 dB Compression (P1dB)	28	31		28	31		26	29		dBm
Saturated Output Power (Psat)		33			33			31		dBm
Output Third Order Intercept (IP3) [2]		41			41			40		dBm
Noise Figure		8			4.5			5		dB
Total Supply Current		500			500			500		mA

[1] Adjust Vgg between -2 to 0V to achieve Idd = 500 mA typical.

[2] Measurement taken at Pout / tone = +14 dBm.

GaAs pHEMT MMIC 2 WATT POWER AMPLIFIER, 0.1 - 20 GHz

Pin Descriptions

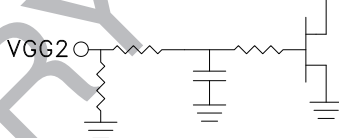
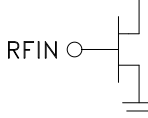
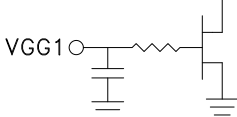
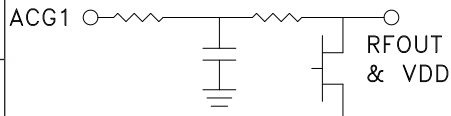
Pin Number	Function	Description	Interface Schematic
1, 4, 6, 14, 20, 22,	GND	These pins and package bottom must be connected to RF/DC ground.	
2	Vgg2	Gate control for amplifier. Attach bypass capacitor per application circuit herein. For nominal operation +9.5V should be applied to Vgg2.	
3, 7, 8, 9, 10, 11, 12, 17, 18, 19, 23, 24, 25, 26, 27, 28, 31, 32	N/C	These pins are not connected internally, however all data shown herein was measured with these pins connected to RF/DC ground externally.	
5	RFIN	This pad is DC coupled and matched to 50 Ohms. Blocking capacitor is required.	
13	Vgg1	Gate control 1 for amplifier. Attach bypass capacitor per application circuit herein. Please follow "MMIC Biasing Procedure" application note.	
15, 29	ACG4, ACG2	Low frequency termination. Attach bypass capacitor per application circuit.	
21	RFOUT & VDD	RF output for amplifier. Connect DC bias (Vdd) network to provide drain current (Idd). See application circuit herein.	
30	ACG1	Low frequency termination. Attach bypass capacitor per application circuit herein.	

GaAs pHEMT MMIC 2 WATT POWER AMPLIFIER, 0.1 - 20 GHz

Outline Drawing

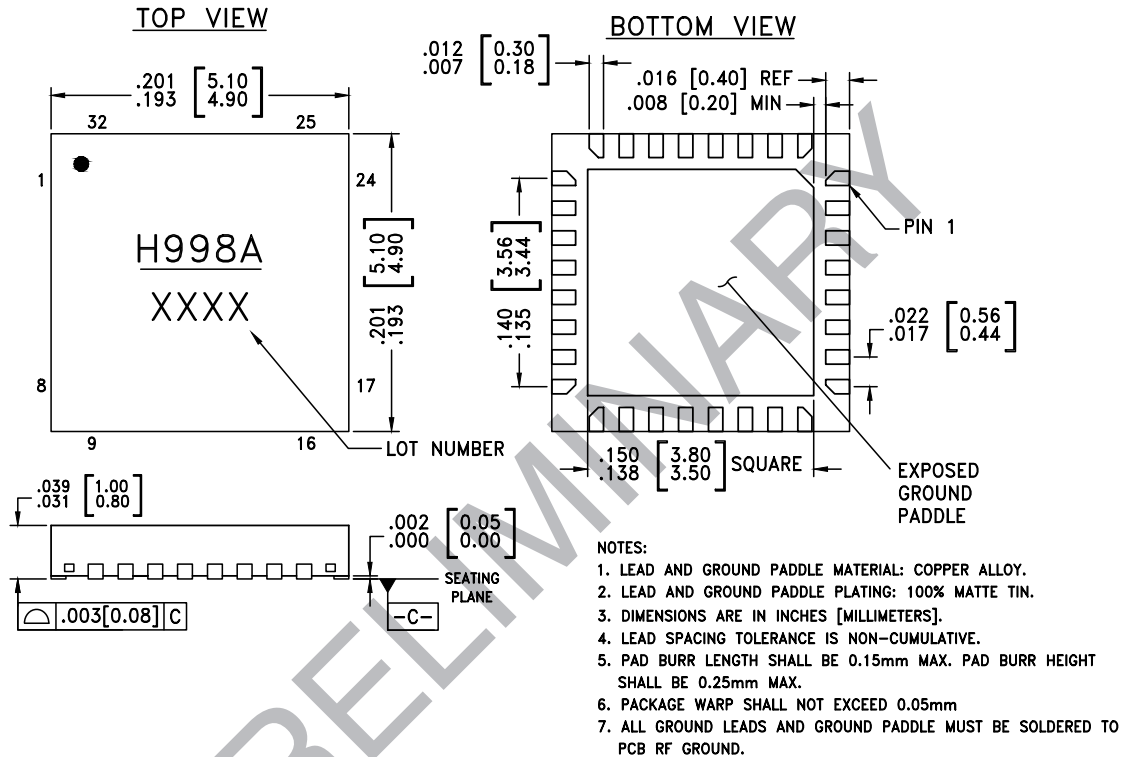

Package Information

Part Number	Package Body Material	Lead Finish	MSL Rating ^[2]	Package Marking ^[1]
HMC998ALP5E	RoHS-compliant Low Stress Injection Molded Plastic	100% matte Sn	MSL3	H998A XXXX

[1] 4-Digit lot number XXXX

[2] Max peak reflow temperature of 260 °C