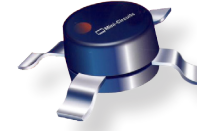

50Ω DC to 8 GHz

Micro-X, 0.085" diameter

The Big Deal

- Low Gain
- Good Gain flatness, ± 0.9 dB
- Broadband matched

Product Overview

ERA-9SM+ (RoHS compliant) is wideband current driven amplifier fabricated using HBT technology. In addition, the ERA-9SM+, has good input and output return loss over a broad frequency range without the need for external matching components. Lead finish is SnAgNi. It has repeatable performance from lot to lot and is enclosed in a 0.085" diameter micro-x package for very good thermal performance.

Key Features

| Feature | Advantages |
|---|---|
| Broadband, DC* to 8 GHz (* Low frequency cut off determined by external coupling capacitors) | A single amplifier covering DC* to 8 band. <ul style="list-style-type: none"> • Reduced component inventory • Ideal for wideband applications such as instrumentation and military |
| Low gain: 8.6 dB typ. at 0.1 GHz and 6.9 dB at 8 GHz | Ideal for increasing the gain of amplifier chain by low value. Typically small gain change may need two components; an amplifier and an attenuator. Use of ERA-9SM+ reduces component count. |
| Good Gain Flatness: ± 0.9 dB | No need for gain flatness compensation over 8 GHz band to realize published gain flatness. |
| Wideband matched Input return loss: 18-25 dB typ. Output return loss: 12-37 dB typ. | No external matching required to realize published return loss. |

Notes

- A. Performance and quality attributes and conditions not expressly stated in this specification document are intended to be excluded and do not form a part of this specification document.
 B. Electrical specifications and performance data contained in this specification document are based on Mini-Circuit's applicable established test performance criteria and measurement instructions.
 C. The parts covered by this specification document are subject to Mini-Circuits standard limited warranty and terms and conditions (collectively, "Standard Terms"); Purchasers of this part are entitled to the rights and benefits contained therein. For a full statement of the Standard Terms and the exclusive rights and remedies thereunder, please visit Mini-Circuits' website at www.minicircuits.com/MCLStore/terms.jsp

Surface Mount

Monolithic Amplifier

DC-8 GHz

Product Features

- DC-8 GHz
- Gain, 8.4 dB typ. at 2 GHz
- Good gain flatness, ± 0.9 dB typ.
- Output power, 13.8 dBm typ. at 2 GHz
- Internally Matched to 50 Ohms
- Aqueous washable
- Protected by US Patent 6,943,629

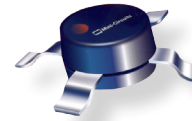

ERA-9SM+

CASE STYLE: WW107

Typical Applications

- Cellular
- PCS
- Communication receivers & transmitters
- Satellite communication, military

+RoHS Compliant

The +Suffix identifies RoHS Compliance. See our web site for RoHS Compliance methodologies and qualifications

General Description

ERA-9SM+ (RoHS compliant) is a wideband current driven low gain, amplifier offering medium dynamic range. It has repeatable performance from lot to lot. It is enclosed in a 0.085" diameter micro-x package.

simplified schematic and pin description

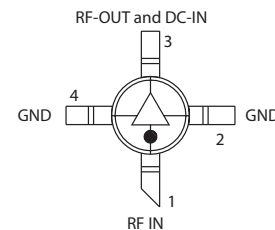
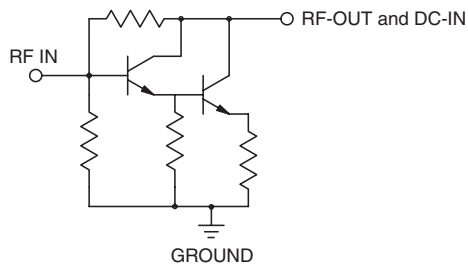

| Function | Pin Number | Description |
|------------------|------------|--|
| RF IN | 1 | RF input pin. This pin requires the use of an external DC blocking capacitor chosen for the frequency of operation. |
| RF-OUT and DC-IN | 3 | RF output and bias pin. DC voltage is present on this pin; therefore a DC blocking capacitor is necessary for proper operation. An RF choke is needed to feed DC bias without loss of RF signal due to the bias connection, as shown in "Recommended Application Circuit". |
| GND | 2,4 | Connections to ground. Use via holes as shown in "Suggested Layout for PCB Design" to reduce ground path inductance for best performance. |

Notes

- Performance and quality attributes and conditions not expressly stated in this specification document are intended to be excluded and do not form a part of this specification document.
- Electrical specifications and performance data contained in this specification document are based on Mini-Circuit's applicable established test performance criteria and measurement instructions.
- The parts covered by this specification document are subject to Mini-Circuits standard limited warranty and terms and conditions (collectively, "Standard Terms"); Purchasers of this part are entitled to the rights and benefits contained therein. For a full statement of the Standard Terms and the exclusive rights and remedies thereunder, please visit Mini-Circuits' website at www.minicircuits.com/MCLStore/terms.jsp



Electrical Specifications at 25°C and 50mA, unless noted

| Parameter | Condition (GHz) | Min. | Typ. | Max. | Units |
|---|-----------------|------|------|------|-------|
| Frequency Range* | | DC | | 8 | GHz |
| Gain | 0.1 | — | 8.6 | — | dB |
| | 1 | — | 8.5 | — | |
| | 2 | 7.4 | 8.3 | 9.0 | |
| | 4 | — | 7.8 | — | |
| | 5 | — | 7.4 | — | |
| | 8 | — | 6.9 | — | |
| Input Return Loss | 0.1 | | 24.0 | | dB |
| | 1 | | 24.4 | | |
| | 2 | | 25.0 | | |
| | 4 | | 24.0 | | |
| | 5 | | 21.9 | | |
| | 8 | | 18.6 | | |
| Output Return Loss | 0.1 | | 37.3 | | dB |
| | 1 | | 32.4 | | |
| | 2 | | 23.8 | | |
| | 4 | | 17.8 | | |
| | 5 | | 15.5 | | |
| | 8 | | 11.9 | | |
| Output IP3 | 0.1 | | 31.1 | | dBm |
| | 1 | | 31.3 | | |
| | 2 | | 30.1 | | |
| | 4 | | 25.4 | | |
| | 5 | | 23.4 | | |
| | 8 | | 19.4 | | |
| Output Power @ 1 dB compression | 0.1 | — | 14.3 | — | dBm |
| | 1 | — | 14.1 | — | |
| | 2 | 12.8 | 14.1 | — | |
| | 4 | — | 12.5 | — | |
| | 5 | — | 10.9 | — | |
| | 8 | — | 7.9 | — | |
| Noise Figure | 0.1 | | 5.1 | | dB |
| | 1 | | 5.3 | | |
| | 2 | | 5.3 | | |
| | 4 | | 5.3 | | |
| | 5 | | 5.3 | | |
| | 8 | | 5.4 | | |
| Recommended Device Operating Current (Id) | | | 50 | | mA |
| Device Operating Voltage (Vd) | | 3.6 | 4.0 | 4.4 | V |
| Device Voltage Variation vs. Temperature at 50 mA | | | -2.6 | | mV/°C |
| Device Voltage Variation vs. Current at 25°C | | | 17.5 | | mV/mA |
| Thermal Resistance, junction-to-case ¹ | | | 138 | | °C/W |

*Low frequency cut off determined by external coupling capacitors.

Absolute Maximum Ratings

| Parameter | Ratings |
|------------------------|---------------------|
| Operating Temperature* | -40°C to 85°C |
| Storage Temperature | -65°C to 150°C |
| Operating Current | 74 mA |
| Input Power | 26 dBm (5 min max.) |
| | 15 dBm (continuous) |

Note: Permanent damage may occur if any of these limits are exceeded.

These ratings are not intended for continuous normal operation.

¹Case is defined as ground leads.

Notes

- A. Performance and quality attributes and conditions not expressly stated in this specification document are intended to be excluded and do not form a part of this specification document.
 B. Electrical specifications and performance data contained in this specification document are based on Mini-Circuit's applicable established test performance criteria and measurement instructions.
 C. The parts covered by this specification document are subject to Mini-Circuits standard limited warranty and terms and conditions (collectively, "Standard Terms"); Purchasers of this part are entitled to the rights and benefits contained therein. For a full statement of the Standard Terms and the exclusive rights and remedies thereunder, please visit Mini-Circuits' website at www.minicircuits.com/MCLStore/terms.jsp



Characterization Test Circuit

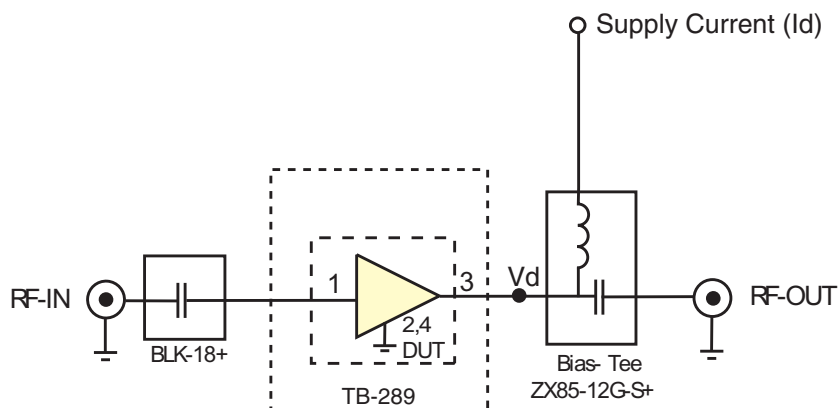
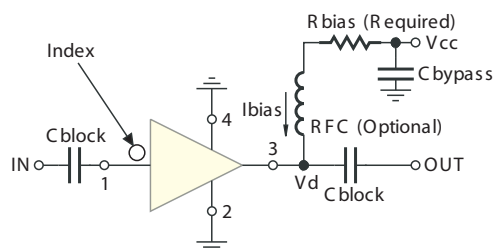

Fig 1. Block Diagram of Test Circuit used for characterization. (DUT soldered on Mini-Circuits Characterization test board TB-289) Gain, Return loss, Output power at 1dB compression (P1 dB) , output IP3 (OIP3) and noise figure measured using Agilent’s N5242A PNA-X microwave network analyzer.

Conditions:

1. Gain and Return loss: Pin= -25dBm
2. Output IP3 (OIP3): Two tones, spaced 1 MHz apart, -5 dBm/tone at output.

Recommended Application Circuit



Test Board includes case, connectors, and components (in bold) soldered to PCB

Product Marking

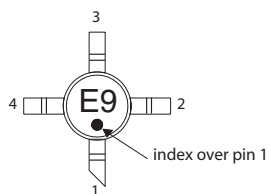

| R BIAS | |
|--------|---|
| Vcc | “1%” Res. Values (ohms) for Optimum Biasing |
| 7 | 61.9 |
| 8 | 80.6 |
| 9 | 100 |
| 10 | 121 |
| 11 | 140 |
| 12 | 165 |
| 13 | 182 |
| 14 | 200 |
| 15 | 221 |
| 16 | 237 |
| 17 | 261 |
| 18 | 274 |
| 19 | 301 |
| 20 | 316 |

Notes

- A. Performance and quality attributes and conditions not expressly stated in this specification document are intended to be excluded and do not form a part of this specification document.
- B. Electrical specifications and performance data contained in this specification document are based on Mini-Circuit’s applicable established test performance criteria and measurement instructions.
- C. The parts covered by this specification document are subject to Mini-Circuits standard limited warranty and terms and conditions (collectively, “Standard Terms”); Purchasers of this part are entitled to the rights and benefits contained therein. For a full statement of the Standard Terms and the exclusive rights and remedies thereunder, please visit Mini-Circuits’ website at www.minicircuits.com/MCLStore/terms.jsp



| Additional Detailed Technical Information | |
|---|--|
| <i>additional information is available on our dash board. To access this information click here</i> | |
| Performance Data | Data Table |
| | Swept Graphs |
| | S-Parameter (S2P Files) Data Set (.zip file) |
| Case Style | WW107, Plastic micro-x 0.085 <i>body diameter</i> , <i>lead finish: tin-silver over nickel</i> |
| Tape & Reel Standard quantities available on reel | F4 <i>7" Reels with 20, 50, 100, 200, 500, 1K devices</i> |
| Suggested Layout for PCB Design | 98-PL-075 |
| Evaluation Board | TB-408-9SM+ |
| Environmental Ratings | ENV08T1 |

ESD Rating

Human Body Model (HBM): Class 1B (500 to <1000V) in accordance with ANSI/ESD STM 5.1 - 2001

Machine Model (MM): Class M1(25V) in accordance with ANSI/ESD STM5.2-1999

MSL Rating

Moisture Sensitivity: MSL1 in accordance with IPC/JEDEC J-STD-020D

MSL Test Flow Chart

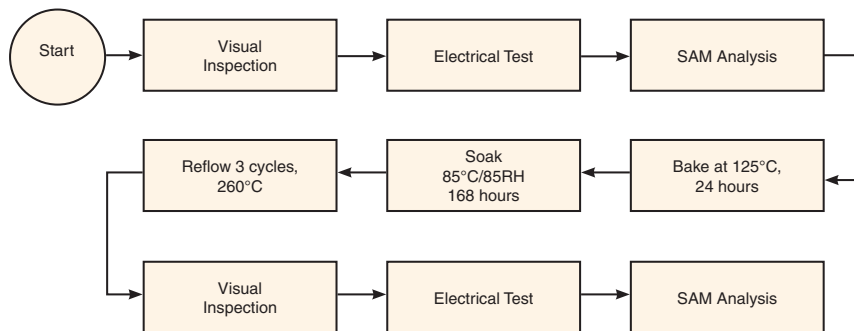

Notes

- A. Performance and quality attributes and conditions not expressly stated in this specification document are intended to be excluded and do not form a part of this specification document.
- B. Electrical specifications and performance data contained in this specification document are based on Mini-Circuit's applicable established test performance criteria and measurement instructions.
- C. The parts covered by this specification document are subject to Mini-Circuits standard limited warranty and terms and conditions (collectively, "Standard Terms"); Purchasers of this part are entitled to the rights and benefits contained therein. For a full statement of the Standard Terms and the exclusive rights and remedies thereunder, please visit Mini-Circuits' website at www.minicircuits.com/MCLStore/terms.jsp

