

Features

- Low Noise Figure: 1.6 dB
- High Input IP3: -6 dBm at 3 V, 6.5 mA bias
- High Gain: 18 dB
- Single Supply: +3 to +8 VDC
- Adjustable current: 3 to 20 mA with external resistor
- SOT-26 Plastic Package

Description

M/A-COM's AM50-0006 is a high dynamic range, GaAs MMIC, low noise amplifier in a SOT-26 surface mount plastic package. It employs external input matching to obtain optimum noise figure performance and operating frequency flexibility.

The AM50-0006 also features flexible biasing to control the current consumption vs. dynamic range trade-off. The AM50-0006 can operate from any positive supply voltage in the 3 V to 8 V range. Its current can be controlled over a range of 3 mA to 20 mA with an external resistor.

The AM50-0006 is ideally suited for use where low noise figure, high gain, high dynamic range, and low power consumption are required. Typical applications included receiver front ends in PDC-1500, DCS-1800, DCS-1900 and other PCN/PCS applications. It is also useful as a gain block, buffer, driver, and IF amplifier in both fixed or portable PDC, PHS, and PCN/PCS systems.

The AM50-0006 is fabricated using a low-cost 0.5-micron gate length GaAs process. The process features full passivation for increased performance and reliability. The AM50-0006 is 100% RF tested to ensure performance specification compliance.

Functional Block Diagram

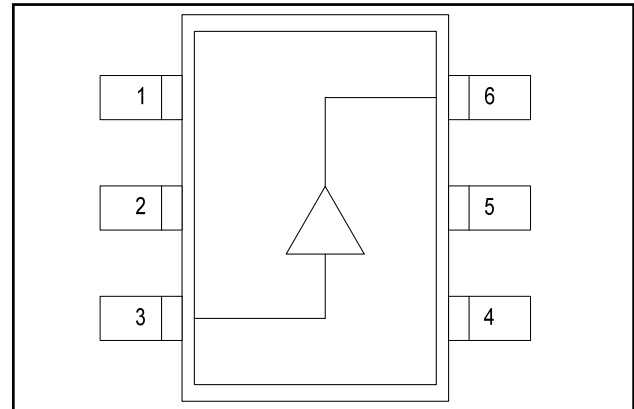

Pin Configuration

Pin No.	Pin Name	Description
1	GND	RF and DC Ground
2	R _{EXT} C _{EXT}	External Current Control By-Pass Capacitor
3	RF Input	RF Input of the amplifier
4	V _{DD}	Positive supply voltage
5	GND	RF and DC Ground
6	RF Output	RF Output of the amplifier

Ordering Information ¹

Part Number	Package
AM50-0006	SOT-26 Plastic Package
AM50-0006TR	Forward Tape and Reel
AM50-0006PDC	1400-1520 MHz Designer's Kit
AM50-0006PCS	1700-2000 MHz Designer's Kit

1. Reference Application Note M513 for reel size information.

Electrical Specifications²: $T_A = +25^\circ\text{C}$, $Z_0 = 50 \Omega$, $P_{in} = -30 \text{ dBm}$

Parameter	Test Conditions	Units	1500 MHz			1900 MHz		
			Min.	Typ.	Max.	Min.	Typ.	Max.
Gain	$V_{DD} = 3 \text{ Volts}$	dB	15	18	20	15	17.5	20
Noise Figure	$V_{DD} = 3 \text{ Volts}$	dB	—	1.60	2.00	—	1.65	2.00
Input VSWR	—	Ratio	—	2.2:1	—	—	1.5:1	—
Output VSWR	—	Ratio	—	1.5:1	—	—	1.5:1	—
Output 1 dB Compression	$V_{DD} = 3 \text{ Volts}$	dBm	—	1	—	—	0	—
Input IP3	$V_{DD} = 3 \text{ Volts}$	dBm	—	-5.0	—	—	-6.0	—
Reverse Isolation	—	dB	—	35	—	—	35	—
Drain Current	$V_{DD} = 3 \text{ Volts}$	mA	4.5	6.5	10	4.5	6.5	10

2. Using external 120 ohm resistor. See Functional Schematics.

Absolute Maximum Ratings^{3,4}

Parameter	Absolute Maximum
V_{DD}	+10 VDC
Input Power	+17 dBm
Current ⁵	30 mA
Channel Temperature ⁶	+150°C
Operating Temperature	-40°C to +85°C
Storage Temperature	-65°C to +150°C

- Exceeding any one or combination of these limits may cause permanent damage to this device.
- M/A-COM does not recommend sustained operation near these survivability limits.
- When pin #2 is used to increase current (see note 8).
- Thermal resistance (θ_{jc}) = +150°C/W.

SOT-26[†]

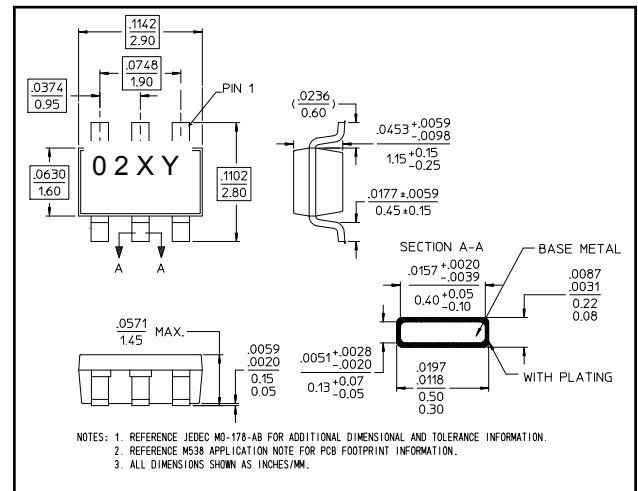

[†] Meets JEDEC moisture sensitivity level 1 requirements.

Handling Procedures

Please observe the following precautions to avoid damage:

Static Sensitivity

Gallium Arsenide Integrated Circuits are sensitive to electrostatic discharge (ESD) and can be damaged by static electricity. Proper ESD control techniques should be used when handling these devices.

ADVANCED: Data Sheets contain information regarding a product M/A-COM Technology Solutions is considering for development. Performance is based on target specifications, simulated results, and/or prototype measurements. Commitment to develop is not guaranteed.
PRELIMINARY: Data Sheets contain information regarding a product M/A-COM Technology Solutions has under development. Performance is based on engineering tests. Specifications are typical. Mechanical outline has been fixed. Engineering samples and/or test data may be available. Commitment to produce in volume is not guaranteed.

- **North America** Tel: 800.366.2266 / Fax: 978.366.2266
- **Europe** Tel: 44.1908.574.200 / Fax: 44.1908.574.300
- **Asia/Pacific** Tel: 81.44.844.8296 / Fax: 81.44.844.8298

Visit www.macontech.com for additional data sheets and product information.

M/A-COM Technology Solutions Inc. and its affiliates reserve the right to make changes to the product(s) or information contained herein without notice.

Data for 1700 - 2000 MHz Operation

Functional Schematic

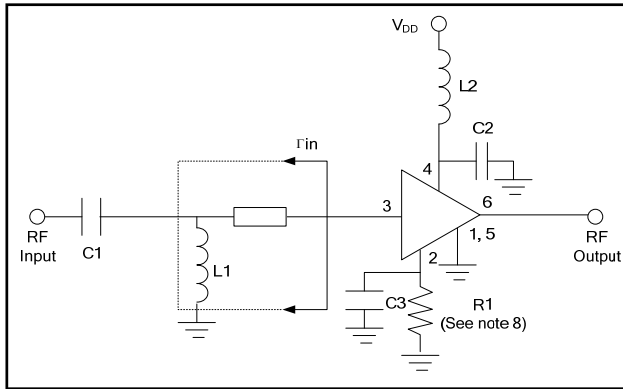

Recommended PCB Configuration

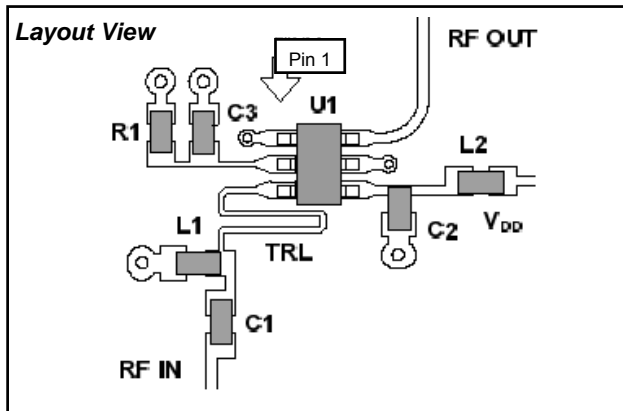

Cross Section View

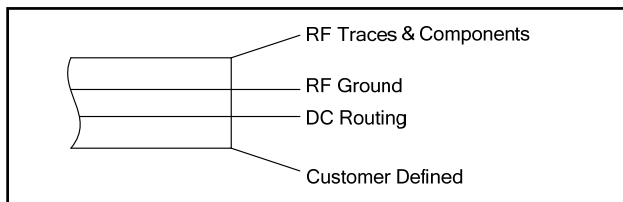

The PCB dielectric between RF traces and RF ground layers should be chosen to reduce RF discontinuities between 50 Ω lines and package pins. M/A-COM recommends an FR-4 dielectric thickness of 0.008" (0.20 mm) yielding a 50 Ω line width of 0.015" (0.38 mm). The recommended RF metalization thickness is 1 ounce copper.

Input Reflection Coefficient

Frequency	1700 MHz	1850 MHz	2000 MHz
Γ_{in} (mag)	0.699	0.674	0.649
Γ_{in} (ang)	48.47°	38.68°	29.27°

External Circuitry Parts List ⁷

Part	Value	Purpose
C1	47 pF	DC Block
C2	470 pF	By-Pass
L1	2.7 nH	Tuning
L2	22 nH	RF Choke
R1	See note 8	Current control
C3	470 pF	By-Pass

- All external circuitry parts are readily available, low cost surface mount components (.060 in. x .030 in. or .080 in. x .050 in.)
- Pin 2 allows use of an external resistor to ground for optional, higher current.
For $I_{DD} \sim 5$ mA, $R1 = 150$ ohms;
 $I_{DD} \sim 6.5$ mA, $R1 = 120$ ohms;
 $I_{DD} \sim 20$ mA, $R1 = 27$ ohms.

Typical Performance Curves, 1700 - 2000 MHz

Gain vs. Bias @ +25°C

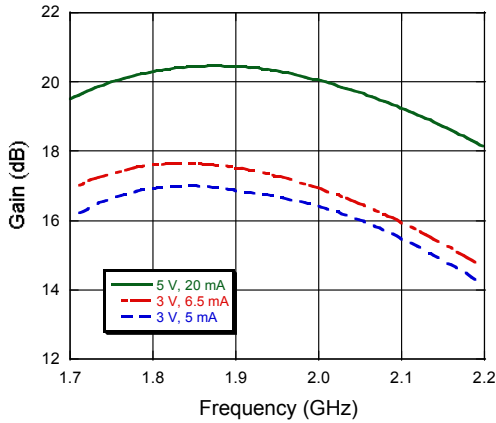

Input IP3 vs. Bias @ +25°C

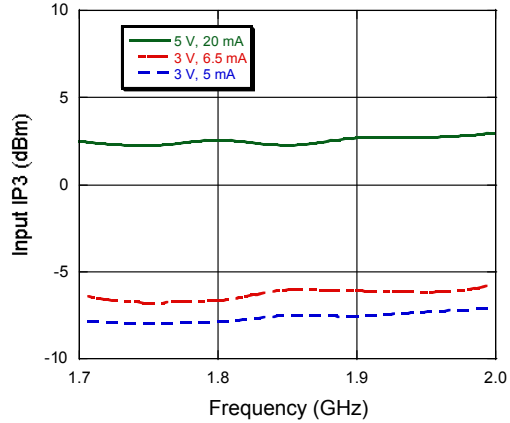

Noise Figure (Bias = 3V, 6.5 mA)

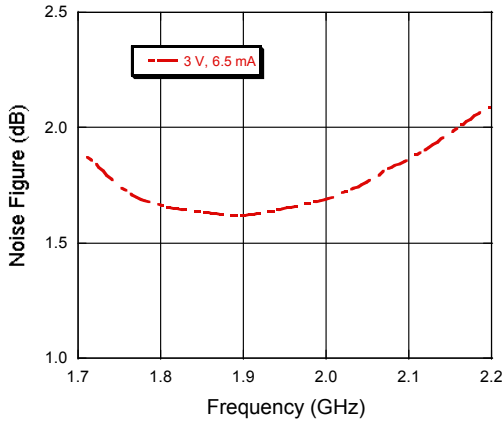

VSWR (Bias = 3V, 6.5 mA)

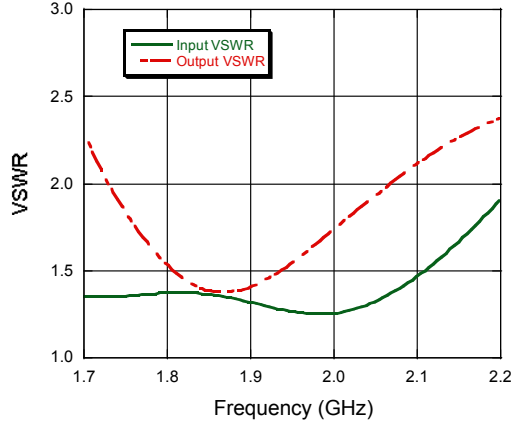

Output P1 dB vs. Bias @ +25°C

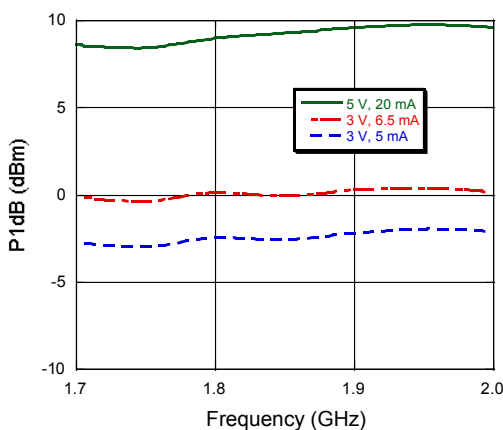

Input IP3 vs. Drain Current (Frequency = 1900 MHz)

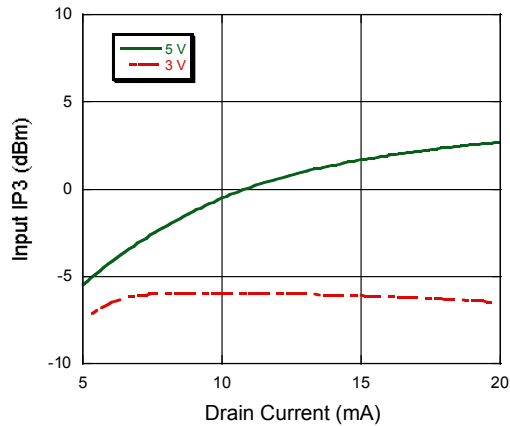

Typical Performance Curves, 1700 - 2000 MHz

Gain vs. Temperature (Bias = 3V, 6.5 mA)

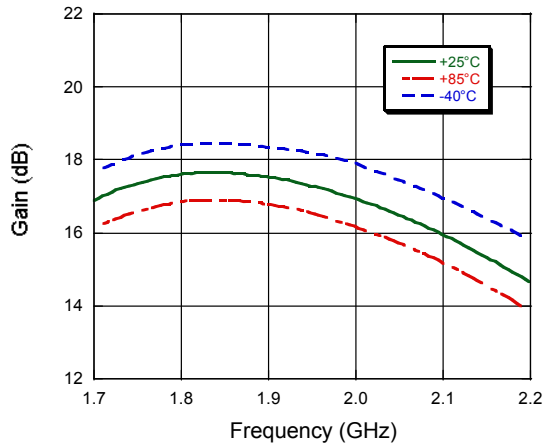

Noise Figure vs. Temperature (Bias = 3V, 6.5 mA)

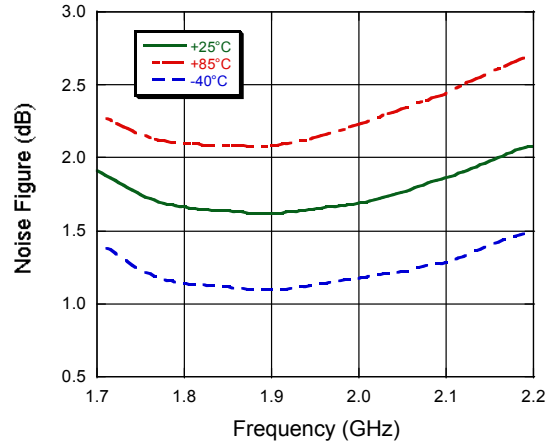

Data for 1400 - 1520 MHz Operation

Functional Schematic

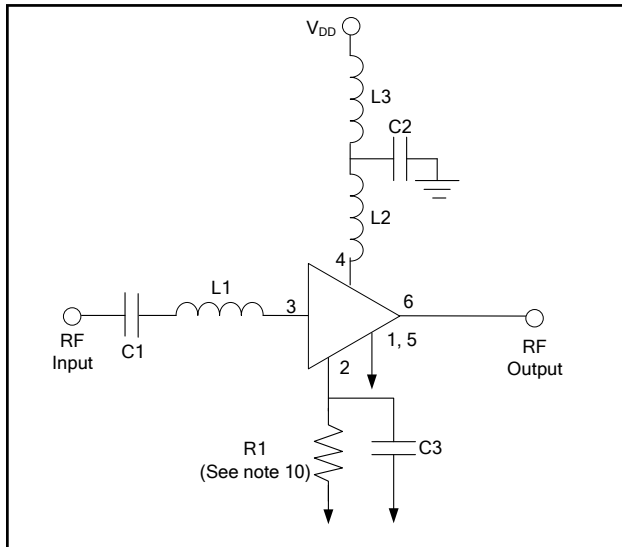

External Circuitry Parts List⁹

Part	Value	Purpose
C1	47 pF	DC Block
C2	470 pF	By-Pass
L1	10 nH	Tuning
L2	3.9 nH	Tuning
L3	22 nH	RF Choke
R1	See note 10	Current control
C3	470 pF	By-Pass

- All external circuitry parts are readily available, low cost surface mount components (.060 in. x .030 in. or .080 in. x .050 in.)
- Pin 2 allows use of an external resistor to ground for optional, higher current.
For $I_{DD} \sim 5$ mA, $R1 = 150$ ohms;
For $I_{DD} \sim 6.5$ mA, $R1 = 120$ ohms;
For $I_{DD} \sim 20$ mA, $R1 = 27$ ohms.

Recommended PCB Configuration

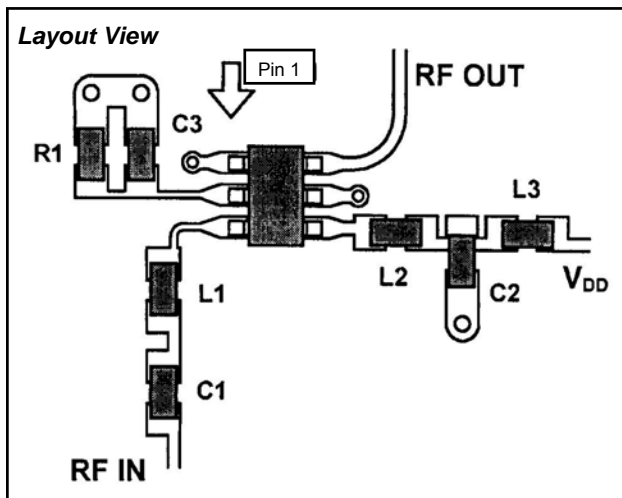

Cross Section View

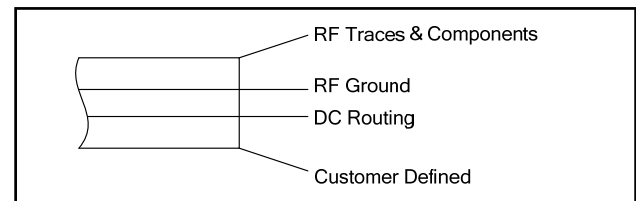

The PCB dielectric between RF traces and RF ground layers should be chosen to reduce RF discontinuities between 50 Ω lines and package pins. M/A-COM recommends an FR-4 dielectric thickness of 0.008" (0.20 mm) yielding a 50 Ω line width of 0.015" (0.38 mm). The recommended RF metalization thickness is 1 ounce copper.

Typical Performance Curves, 1400 - 1520 MHz

Gain vs. Bias @ +25°C

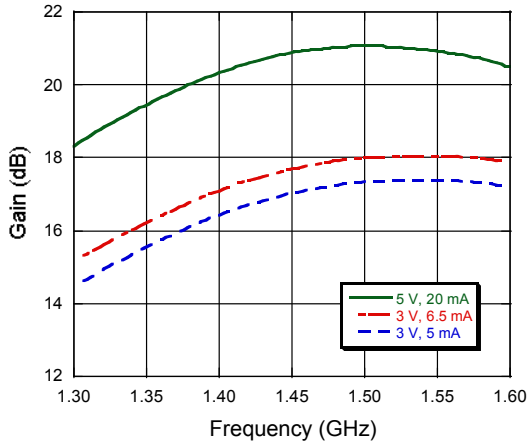

Input IP3 vs. Bias @ +25°C

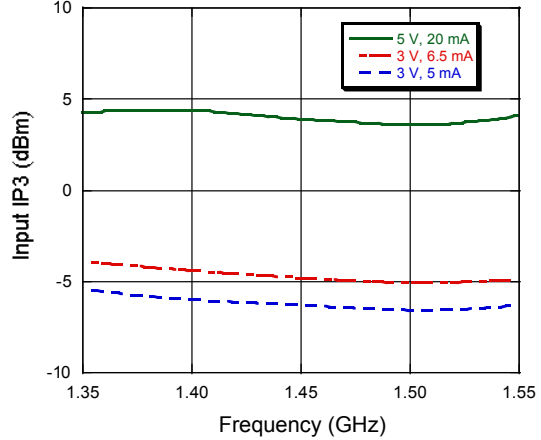

Noise Figure (Bias = 3V, 6.5 mA)

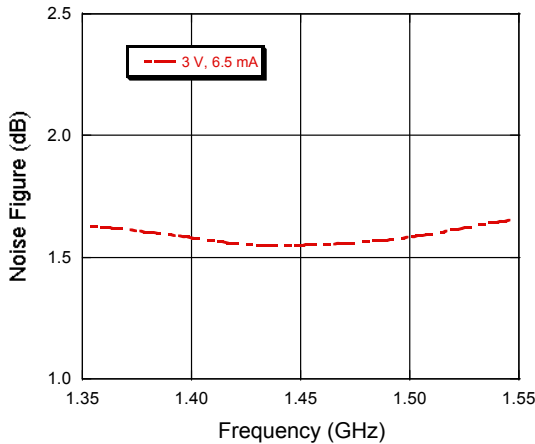

VSWR (Bias = 3V, 6.5 mA)

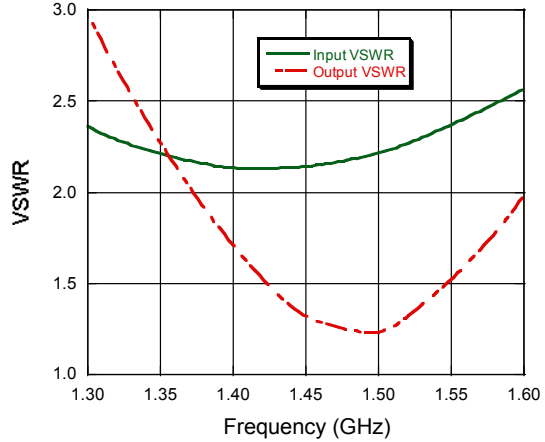

Output P1 dB vs. Bias @ +25°C

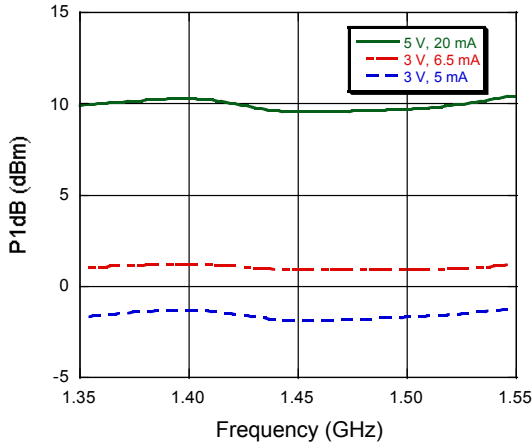

Input IP3 vs. Drain Current (Frequency = 1500 MHz)

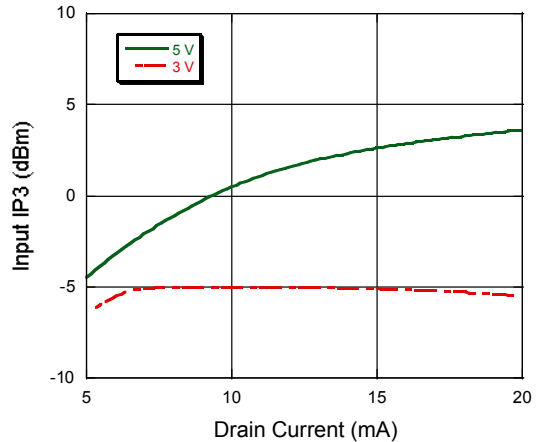

Typical Performance Curves, 1400 - 1520 MHz

Gain vs. Temperature (Bias = 3V, 6.5 mA)

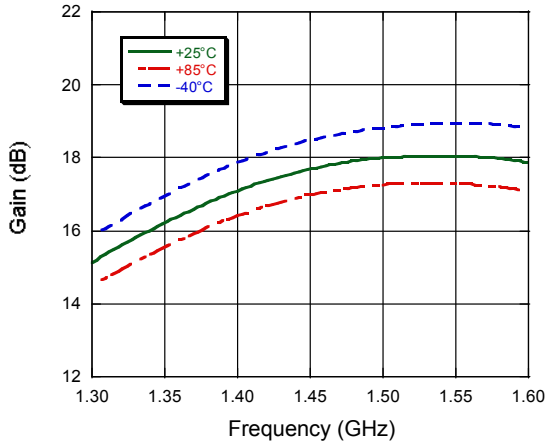

Noise Figure vs. Temperature (Bias = 3V, 6.5 mA)

