

Section 14

Waveguide Bends & Twists

Theory

Rectangular waveguide usually is operated with the electric (E) field across the narrow dimension, and with the magnetic loops (H) field across the wide dimension.

A waveguide bend with the plane of its electric field changed is called an “E-Bend.” With the plane of its magnetic field changed, the waveguide bend is called an “H-Bend.” The distinction can be remembered readily if one thinks of the E-Bend being bent in the Easy direction, and the H-bend in the Hard direction.

E- Bend

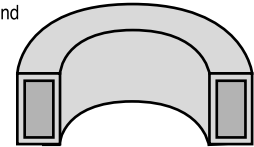

H- Bend

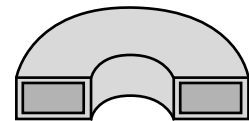

Styles

MDL offers one of the most complete lines of waveguide bends in the industry. Basic styles in many bends include miter and radius 90° bends, as well as acute and obtuse E and H plane bends in angles from 30° to 180°. MDL's dual-E and offset bends were developed to economize and simplify production requirements, and are now used extensively throughout the field.

Various bend terminations are available including socket, waveguide, and flange. A socket termination is used for adding extra lengths of waveguide, permitting alignment of the inside dimensions and facilitating soldering. Waveguide terminations on cast bends are integrally cast and meet standard waveguide dimensions. Waveguide terminations are generally used where a short waveguide extension is desired. Lengths shown are maximum, but shorter lengths can be machined without damage to electrical performance.

Flange terminations listed in this catalog are integrally cast. However, flanges can be fabricated to other bends upon special request. MDL's exacting production capabilities insure consistent mechanical and electrical reproduction – an important factor for production. MDL welcomes all inquiries on designing prototype bends or producing an established design.

Notes: 1. Tolerances on quadrants of all 90° cast bends are:

- ± .003 WR22, WR28, WR34, WR42, WR51
- ± .005 WR62, WR75, WR90, WR102, WR112, WR137
- ± .008 WR159, WR187
- ± .010 WR229, WR284

All other dimensions are for reference use only.

- 2. VSWR: 1.05:1 maximum
- 3. All corral openings are made to accept standard WR size waveguide per MIL-W-85.
- 4. All dimensions and specifications are subject to change without notice.
Contact MDL for specific dimensions and tolerances
- 5. Style 4E and 4H are true radius bends.
- 6. Drawings shown do not necessarily represent actual casting configurations.
- 7. Finish: Inside and outside, C-12/125 microinches per NAS 823.
- 8. Material Code: A - Aluminum Alloy D712 in accordance with ASTM B-26.
B - Copper Alloy C82500 in accordance with Federal spec QQC-390.
S - Silicon Bronze Alloy S87200 in accordance with Federal spec QQC-390.

Section 14

Waveguide Bends & Twists



Introduction

Microwave Development Laboratories, Inc., has utilized its full design and development capabilities to improve and supplement the performance of cast waveguide bends. As a result of extensive research, MDL now offers the most complete line of cast bends in the industry. These units are cast within MDL's own foundry facilities. Quality control standards are such as to insure the highest calibre casting. VSWR characteristics of these bends is typically 1.03 with a maximum of 1.05.

Units are readily supplied from stock or on short term delivery. In addition to these items, unusual configuration can be fabricated or castings developed to meet specific requirements if customers demands cannot be met with these basic designs.

Waveguide Bends

WAVEGUIDE BENDS

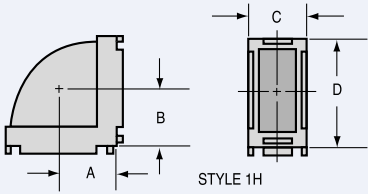

STYLE 1H

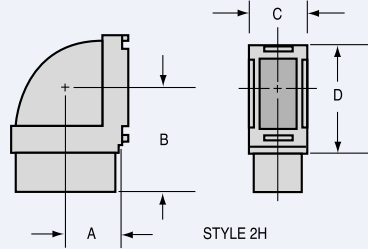

STYLE 2H

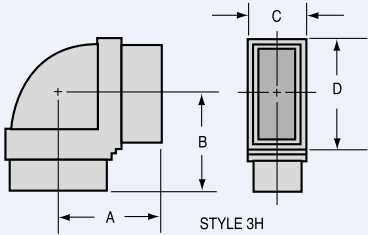

STYLE 3H

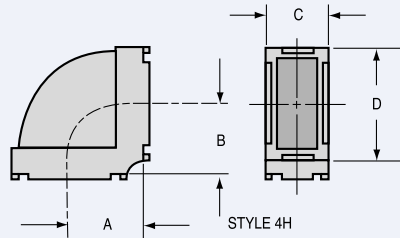

STYLE 4H

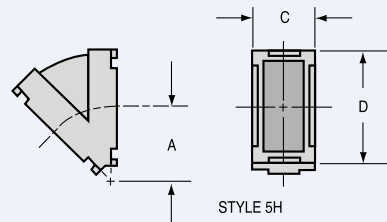

STYLE 5H

W/G Size Freq GHz	Angle	Style	Model Number	Dimensions				
				A	B	Ref C	Ref D	
WR22 33.0 to 50.0 GHz	90°	1E	22BE11	.125	.125	.40	.30	
		1H	22BH11	.187	.187	.30	.40	
		3E	22BE31	Under Development				
		3H	22BH31	Under Development				
	45°	5E	22BE22	.169	-	.40	.30	
		5H	22BH22	.322	-	.30	.40	
	30°	5E	22BE12	.138	-	.40	.30	
		5H	22BH12	.387	-	.40	.30	
	WR28 26.50 to 40.00 GHz	90°	1E	28BE11	.140	.140	.44	.30
			2E	28BE22	.140	.375	.44	.35
3E			28BE12	.375	.375	.44	.35	
1H			28BH11	.210	.210	.30	.44	
1H			28BH111	.343	.343	.30	.44	
2H			28BH22	.210	.610	.30	.47	
45°		3H	28BH32	.610	.610	.30	.47	
		5E	28BE82	.221	.233	.44	.30	
30°		5H	28BH82	.221	.339	.30	.44	
		5E	28BE72	.151	.152	.44	.30	
5H		28BH72	.151	.407	.30	.44		
		WR34 22.0 to 33.0 GHz	90°	1E	34BE11	.170	.170	.50
1H				34BH11	.255	.255	.34	.50
45°			5E	34BE22	.278	-	.50	.34
			5H	34BH22	.278	.373	.34	.50
30°			5E	34BE12	.166	.170	.50	.34
	5H		34BH12	.166	.437	.34	.50	
WR42 18.00 to 26.50 GHz	90°	1E	42BE11	.170	.170	.60	.35	
		2E	42BE82	.170	.480	.60	.44	
		3E	42BE92	.480	.480	.60	.44	
		1H	42BH11	.300	.300	.35	.60	
		2H	42BH82	.300	.609	.35	.69	
		3H	42BH92	.609	.609	.35	.69	
	45°	5E	42BE42	.155	.179	.61	.35	
		5H	42BH42	.290	.304	.35	.61	
	30°	5E	42BE12	.210	-	.61	.35	
		5H	42BH12	.335	-	.35	.61	
	WR51 15.00 to 22.00 GHz	90°	1E	51BE11	.187	.187	.67	.42
			2E	51BE32	.187	.600	.71	.48
			3E	51BE42	.600	.600	.71	.48
			4E	51BE12	.318	.318	.69	.50
1H			51BH11	.312	.312	.42	.67	
2H			51BH52	.312	.725	.46	.71	
45°		3H	51BH62	.725	.725	.46	.71	
		4H	51BH12	.399	.399	.43	.68	
30°		5E	51BE52	.241	-	.67	.42	
		5H	51BH22	.900	-	.44	.75	
5E		51BE62	.282	-	.76	.51		
		5H	51BH102	.407	-	.51	.76	

Waveguide Bends

W/G Size Freq GHz	Angle	Style	Model Number	Dimensions			
				A	B	Ref C	Ref D
WR62 12.40 to 18.00 GHz	90°	1E	62BE11	.250	.250	.81	.50
		1E	62BE111	.280	.280	.81	.50
		2E	62BE21	.250	.600	.81	.50
		3E	62BE42	.600	.600	.81	.55
		4E	62BE82	.406	.406	.80	.58
		1H	62BH11	.368	.368	.52	.78
		2H	62BH21	.368	.625	.51	.82
		3H	62BH112	.625	.625	.51	.82
	60°	5E	62BE52	.625	-	.78	.48
		5E	62BE222	.240	-	.79	.48
		5H	62BH192	.396	-	.48	.79
		45°	5E	62BE32	.240	-	.79
	5E	62BE122	.406	-	.86	.56	
		62BE92	.625	-	.80	.50	
		5H	62BH72	.396	-	.48	.79
		30°	5E	62BE22	.240	-	.79
5H	62BH32		.396	-	.48	.79	
WR75 10.00 to 15.00 GHz	90°	1E	75BE11	.325	.325	.95	.58
		1E	75BE111	.312	.312	.95	.56
		2E	75BE21	.325	.750	.95	.58
		3E	75BE32	.750	.750	.95	.58
		1H	75BH11	.484	.484	.57	.95
		1H	75BH111	.500	.500	.56	.94
		2H	75BH21	.484	.875	.57	.95
		3H	75BH32	.875	.875	.57	1.00
	45°	5E	75BE72	.376	-	.97	.59
		5H	75BH72	.800	-	.57	.95
	35°	5E	75BE42	.358	-	.95	.58
	30°	5E	75BE82	.290	-	.95	.58
		5H	75BE82	.290	-	.95	.58
	30°	5H	75BH62	.625	-	.56	.93

W/G Size Freq GHz	Angle	Style	Model Number	Dimensions			
				A	B	Ref C	Ref D

Double Ridge Bends

WRD750 7.50 to 18.0 GHz	4E	D750BE12	.410	.410	.89	.52
	4H	D750BH12	.593	.593	.52	.89
WRD650 6.50 to 18.0 GHz	4E	D650BE11	.815	.815	.92	.52
	4H	D650BH11	.815	.815	.52	.92

WAVEGUIDE BENDS

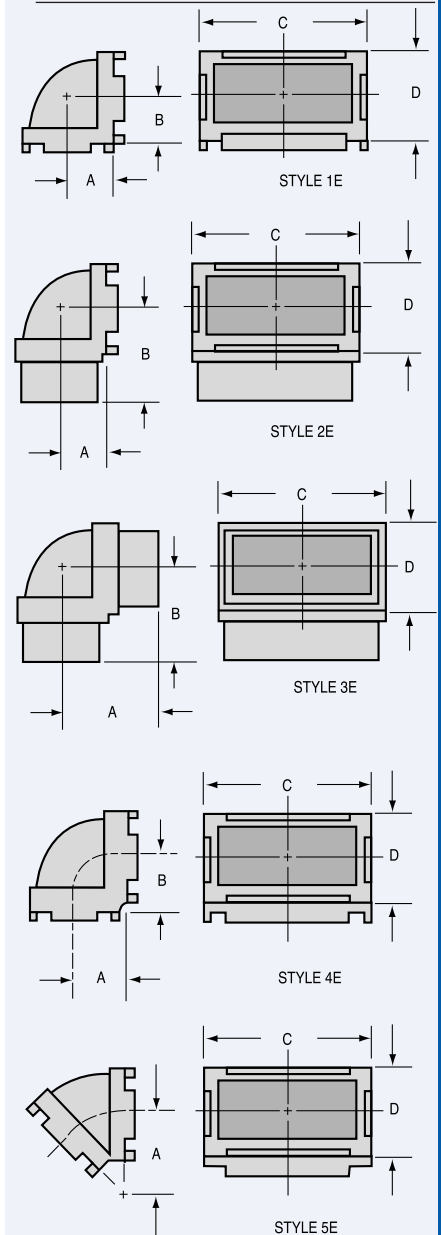

Waveguide Bends

WAVEGUIDE BENDS

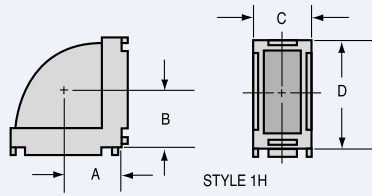

STYLE 1H

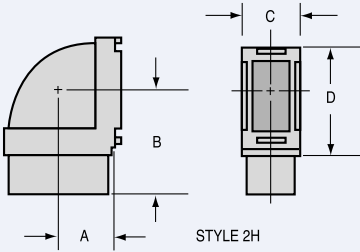

STYLE 2H

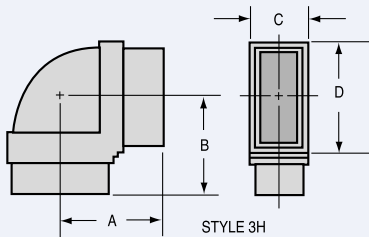

STYLE 3H

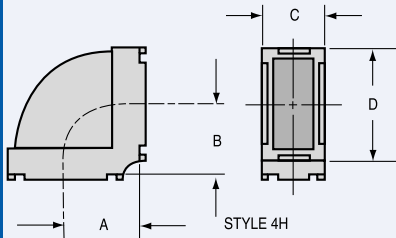

STYLE 4H

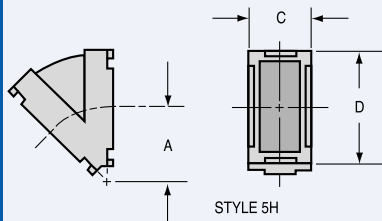

STYLE 5H

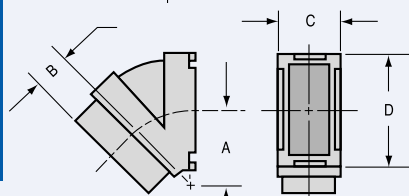

STYLE 6H

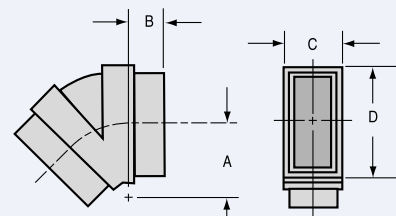

STYLE 7H

W/G Size Freq GHz	Angle	Style	Model Number	Dimensions			
				A	B	Ref C	Ref D
WR90 8.20 to 12.40 GHz	90°	1E	90BE11	.325	.325	1.13	.63
		2E	90BE21	.325	.900	1.12	.63
		3E	90BE112	.906	.906	1.12	.63
		3E	90BE202	.656	1.875	1.12	.64
		4E	90BE42	.453	.453	1.15	.65
		1H	90BH11	.575	.575	.60	1.10
		2H	90BH21	.575	1.030	.63	1.13
		3H ¹	90BH32	1.030	1.030	.63	1.14
		3H	90BH302	1.700	1.500	.63	1.15
		4H	90BH322	.750	.750	.65	1.15
	4H	90BH332	1.500	1.500	.65	1.15	
	60°	5E	90BE212	.453	-	1.13	.63
		5H	90BH292	.750	-	.63	1.13
	45°	5E	90BE232	.453	-	1.13	.63
5H		90BH342	.750	-	.63	1.13	
30°	5E	90BE222	.453	-	1.13	.63	
	5H	90BH312	.750	-	.63	1.13	

Notes: ¹ Rib one side only

Waveguide Bends

W/G Size Freq GHz	Angle	Style	Model Number	Dimensions				
				A	B	Ref C	Ref D	
WR102 7.0 to 11.00 GHz	90°	1E	102BE11	.380	.380	1.27	.76	
		2E	102BE22	.380	.843	1.27	.76	
		3E	102BE32	.843	.843	1.27	.76	
		45°	1H	102BH11	.640	.640	.76	1.27
			2H	102BH22	.640	1.093	.76	1.27
			3H	102BH32	1.093	1.093	.76	1.27
	30°	5E	5E	102BE42	.500	-	1.27	.76
			6E	102BE52	.500	.453	1.27	.76
			7E	102BE62	.500	.453	1.27	.76
		5H	5H	102BH82	.835	-	.76	1.27
			6H	102BE72	.645	-	1.27	.76
			6H	102BE82	.645	.453	1.27	.76
			7H	102BE92	.645	.453	1.27	.76
		5H	102BH42	.835	-	.76	1.27	
	6H	102BH52	.835	.453	.76	1.27		
	7H	102BH62	.835	.453	.76	1.27		

WAVEGUIDE BENDS

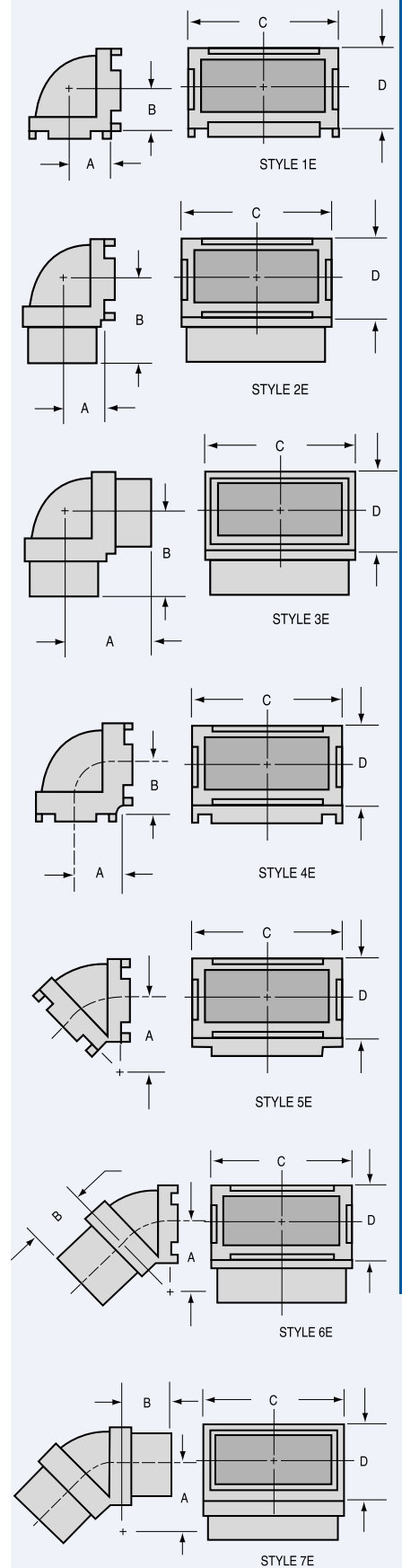

Waveguide Bends

WAVEGUIDE BENDS

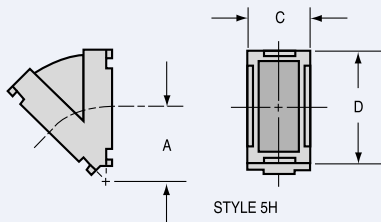
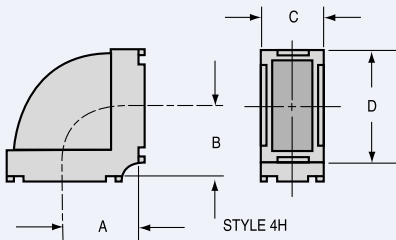
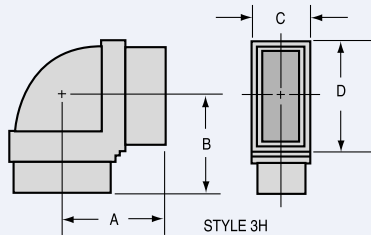
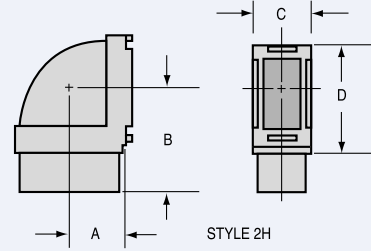
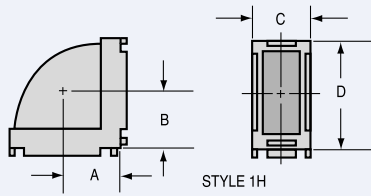

W/G Size Freq GHz	Angle	Style	Model Number	Dimensions				
				A	B	Ref C	Ref D	
WR112 7.05 to 10.00 GHz	90°	1E	112BE11	.344	.344	1.39	.76	
		1E	112BE111	.382	.382	1.39	.76	
		2E	112BE21	.344	.844	1.39	.76	
		3E	112BE32	.844	.844	1.39	.81	
		4E	112BE62	.593	.593	1.36	.74	
		1H	112BH11	.656	.656	.76	1.39	
	45°	1H	112BH111	.695	.695	.76	1.39	
		2H	112BH21	.656	1.156	.76	1.39	
		3H	112BH31*	1.156	.859	.62	1.25	
		5E	112BE42	.594	-	1.38	.75	
		5H	112BH42	1.187	-	.75	1.38	
		30°	5E	112BE52	.594	-	1.38	.75
5H	112BH52	1.187	-	.75	1.38			
WR137 5.85 to 8.20 GHz	90°	1E	137BE11	.438	.438	1.64	.88	
		1E	137BE111	.437	.437	1.62	.87	
		2E	137BE21	.438	.938	1.64	.88	
		3E	137BE32	.938	.938	1.59	.84	
		1H	137BH11	.828	.828	.89	1.63	
		1H	137BH111	.812	.812	.87	1.62	
	45°	2H	137BH21	.828	1.320	.85	1.59	
		3H	137BH32	1.320	1.320	.85	1.59	
		5E	137BE52	.436	-	1.62	.87	
		5H	137BH52	.811	-	.87	1.62	
		30°	5E	137BE42	.467	-	1.62	.87
		5H	137BH42	.842	-	.87	1.62	
WR159 4.90 to 7.05 GHz	90°	1E	159BE11	.550	.550	1.90	1.11	
		2E	159BE22	.550	.915	1.86	1.06	
		3E	159BE32	.915	.915	1.86	1.06	
		1H	159BH11	1.000	1.000	1.11	1.90	
		4H	159BH12	1.562	1.562	1.18	1.96	

Notes: * Cast without exterior ribs

Waveguide Bends

W/G Size Freq GHz	Angle	Style	Model Number	Dimensions			
				A	B	Ref C	Ref D
WR187 3.95 to 5.85 GHz	90°	1E	187BE11	.593	.593	2.18	1.18
		1E	187BE111	.562	.562	2.19	1.18
		2E	187BE32	.593	1.093	2.17	1.17
		3E	187BE22	1.093	1.093	2.17	1.17
		4E	187BE82	1.063	1.063	2.13	1.13
		1H	187BH11	1.062	1.062	1.18	2.18
	45°	2H	187BH22	1.062	1.625	1.18	2.18
		3H	187BH12	1.625	1.625	1.18	2.18
		4H	187BH52	2.187	2.187	1.16	2.16
		5E	187BE62	1.062	-	2.18	1.18
		5H	187BH62	2.187	-	1.18	2.18
		30°	5E	187BE92	1.062	-	2.18
WR229 3.30 to 4.90 GHz	90°	5H	187BH72	2.187	-	1.18	2.18
		1E	229BE11	.700	.700	2.61	1.47
		2E	229BE22	.700	1.093	2.54	1.47
		3E	229BE32	1.093	1.093	2.54	1.47
		1H	229BH11	1.234	1.234	1.46	2.54
		2H	229BH22	1.234	1.718	1.41	2.60
	45°	2H	229BH62	1.234	2.000	1.45	2.60
		3H	229BH32	1.718	1.718	1.41	2.62
		3H	229BH52	2.000	2.000	1.46	2.60
		5E	229BE52	1.500	-	2.61	1.46
WR284 2.60 to 3.95 GHz	90°	5H	229BH72	1.750	-	1.46	2.61
		1E	284BE11	.781	.781	3.25	1.68
		2E	284BE21	.781	1.625	3.25	1.68
		3E	284BE31	1.625	1.625	3.25	1.68
		1H	284BH11	1.531	1.531	1.67	3.18
		2H	284BH21	1.531	3.600	1.67	3.18
	45°	3H	284BH31	3.250	3.600	1.74	3.25
		5E	284BE112	.927	-	3.20	1.70
		5H	284BH82	1.677	-	1.67	3.18
		30°	5E	284BE102	1.045	-	3.20
5H	284BH72		1.748	-	1.67	3.18	

WAVEGUIDE BENDS

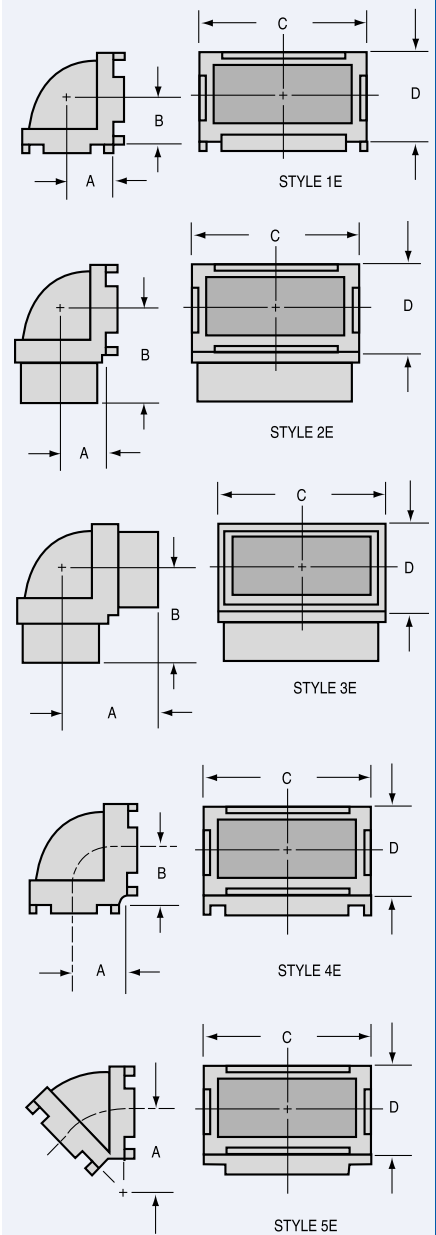

Bends with Flanges

BENDS WITH FLANGES

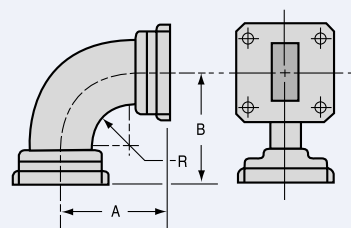

STYLE 1H

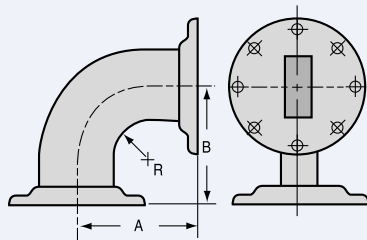

STYLE 2H

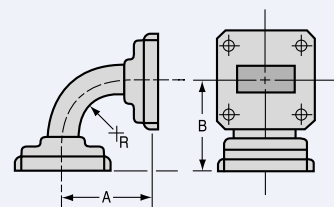

STYLE 1E

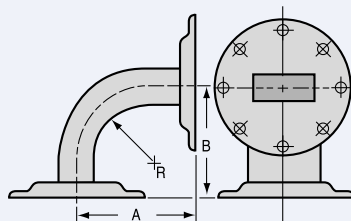

STYLE 2E

W/G Size Freq GHz	Angle	Style	Model Number	Dimensions		
				R	A	B
WR28 26.5 to 40.0 GHz	90°	1E	28BE18	.50	.95	.95
		1H	28BH18	.75	1.27	1.27
WR42 18.0 to 26.5 GHz	90°	1E	42BE18	.75	1.28	1.28
		1H	42BH18	.75	1.41	1.41
WR51 15.0 to 22.0 GHz	90°	1E	51BE18	.57	1.33	1.33
		1H	51BH18	.95	1.69	1.69
WR62 12.4 to 18.0 GHz	90°	1E	62BE18	.68	1.39	1.39
		1H	62BH18	1.00	1.86	1.86
WR75 10.0 to 15.0 GHz	90°	1E	75BE18	.50	1.06	1.06
		1H	75BH18	.87	1.63	1.63
WR90 8.2 to 12.4 GHz	90°	1E	90BE18	.75	1.56	1.56
		1E	90BE28	1.00	1.81	1.81
		1H	90BH18	1.00	2.06	2.06
WR102 7.0 to 11.0 GHz	90°	1E	102BE18	1.00	1.81	1.81
		1H	102BH18	2.00	3.50	3.50
WR112 7.05 to 10.0 GHz	90°	1E	112BE18	.75	1.81	1.81
		1H	112BH18	1.38	2.75	2.75
WR137 5.85 to 8.20 GHz	90°	2E	137BE18	1.00	2.25	2.25
		2H	137BH18	2.00	3.63	3.63
WR187 3.95 to 5.85 GHz	90°	2E	187BE18	4.00	5.56	5.56
		2H	187BH18	4.00	7.06	7.06
WR284 2.60 to 3.95 GHz	90°	2E	284BE18	2.25	4.38	4.38
		2H	284BH18	6.00	9.63	9.63

W/G Size Freq GHz	Angle	Style	Model Number	Dimensions		
				R	A	B

Double Ridge Bends

WRD-750-D24 7.5 to 18.0 GHz	1E*	D750BE18	1.0	1.60	1.60
	1H*	D750BH18	1.0	1.70	1.70

Notes: Tolerance: $\pm .020$

VSWR: 1.1

All flanges equivalent to MIL F 3922.

* Same configuration as 1E & 1H except double ridge. VSWR 1.1:1. Aluminum only.

Special Bends

W/G Size Freq GHz	Angle	Style	Model Number	Dimensions				
				A	B	C	D	CW
WR28 26.5 to 40.0 GHz	90°	1E	28BE52	0.312	0.530	.44	.30	-
		2E	28BE62	0.312	1.330	1.44	.30	-
WR51 15.0 to 22.0 GHz	90°	4E	51BD12	0.316	0.540	1.28	.46	.080
		3H	51BG12	0.355	0.355	0.71	.67	.040
WR51 to WR62		5H	51BH32	1.000	1.000	-	-	-
WR62 12.4 to 18.0 GHz	90°	6E	62BD12	0.210	0.590	1.54	.50	.090
		7E	62BD14	0.406	0.586	1.75	1.31	.040
		9E	62BE162	1.500	1.500	.70	.39	-
		9H	62BH152	1.500	1.500	.39	.70	-
WR75 10.0 to 15.0 GHz	35°	10E	75BE42	.358	-	.95	.58	-
WR90 8.2-12.4 GHz .200 WALL	90°	17E	90BE252	.475	.475	1.43	.93	-
		17H	90BH362	.725	.725	.93	1.43	-

SPECIAL BENDS

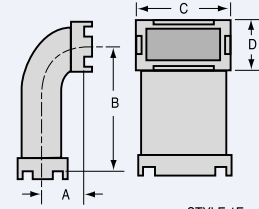

STYLE 1E

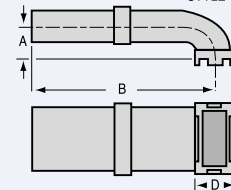

STYLE 2E

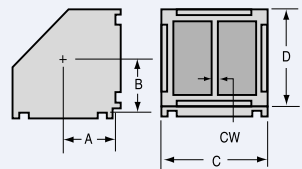

STYLE 3H

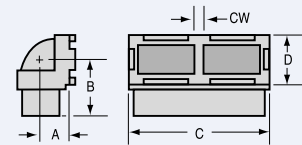

STYLE 4E

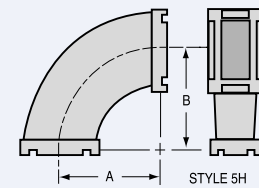

STYLE 5H

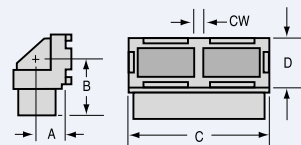

STYLE 6E

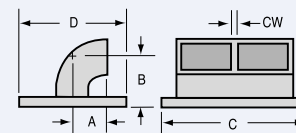

STYLE 7E

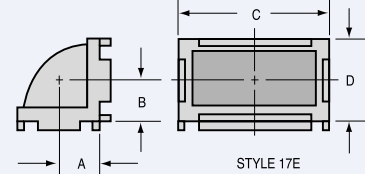

STYLE 17E

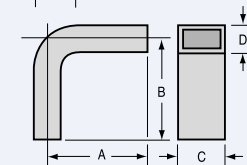

STYLE 9E

SPECIAL BENDS

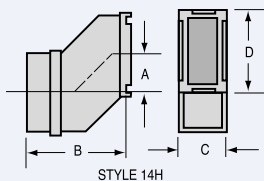
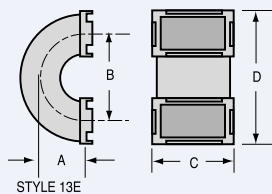
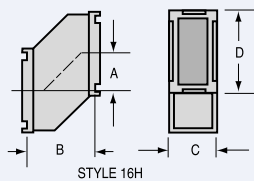
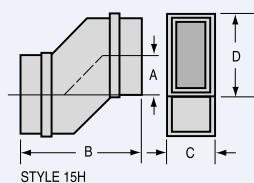
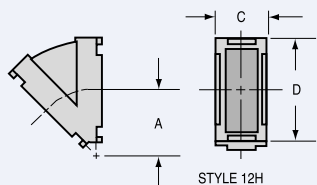
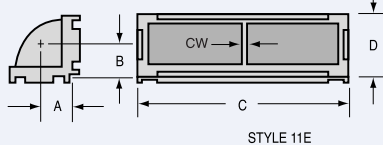
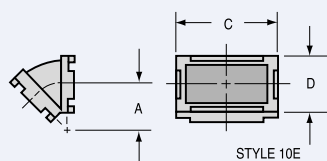
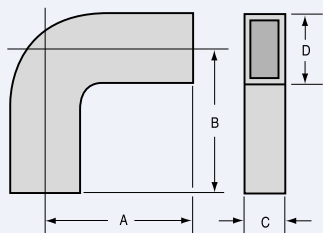
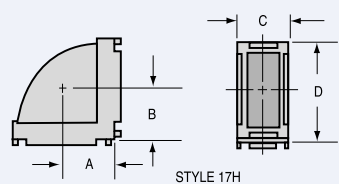

Special Bends

W/G Size Freq GHz	Angle	Style	Model Number	Dimensions				
				A	B	C	D	CW
WR90 8.2 to 12.4 GHz	90°	11E	90BD12	0.325	0.325	2.07	.62	.050
		11E	90BD22	0.325	0.325	2.14	.62	.120
		11E	90BD32	0.453	0.453	2.17	.75	.050
		9E	90BE242	2.125	2.125	1.00	.50	-
		9H	90BH352	2.125	2.125	.50	1.00	-
	70° 34'	5H*	90BH92	1.500	-	.63	1.13	-
	33° 30'	12H	90BH102	1.500	-	.63	1.13	-
	22°	12H	90BH112	1.500	-	.63	1.13	-
	180°	13E	90BE192	0.325	0.650	1.13	1.28	-
WR112 7.05 to 10.0 GHz	90°	9E	112BE172	2.125	2.125	1.25	.62	-
	9H	112BH102	2.125	2.125	.62	1.25	-	
WR137 5.85 to 8.20 GHz	180°	13E	112BE112	0.900	1.625	1.47	2.47	1.05
	15H	137BP12	0.920	2.450	.86	1.61	-	
	14H	137BP22	0.920	2.006	.86	1.61	-	
WR187 3.95 to 5.85 GHz	16H	137BP32	0.920	1.563	.86	1.61	-	
	16H	187BP12	1.250	2.150	1.11	2.11	-	
	14H	187BP22	1.250	2.545	1.11	2.11	-	
WR284 2.60 to 3.95 GHz	15H	187BP32	1.250	2.950	1.11	2.11	-	
	15H	284BP12	1.250	4.190	1.62	3.12	-	
	14H	284BP22	1.250	3.333	1.62	3.12	-	
16H	284BP32	1.250	2.475	1.62	3.12	-		

Notes: * Same as style 5H except 70°

Narrow Height Bends

W/G Size Freq GHz	Degree	Height ID	Style	Model Number	Dimensions				
					A	B	Ref C	Ref D	
WR62 12.40 to 18.00 GHz	90°	.156	1E	A62BE11	.165	.165	.78	.32	
			1H	A62BH11	.368	.368	.32	.76	
	45°	.156	4E	A62BE41	.160	-	.78	.32	
			4H	A62BH41	.396	-	.32	.79	
	90°	.138	1E	B62BE12	.224	.224	.78	.28	
			2E	B62BE22	.224	.750	.78	.28	
			3E	B62BE32	.750	.750	.78	.28	
			1H	B62BH12	.450	.450	.30	.87	
			2H	B62BH22	.450	.670	.30	.87	
			3H	B62BH32	.670	.670	.30	.87	
45°	.138	4H	B62BH42	.450	-	.30	.78		
WR75 10.00 to 15.00 GHz	90°	.200	1E	A75BE12	.225	.225	.93	.45	
			1H	A75BH12	.500	.500	.38	1.00	
			1E ¹	A75BE11	.225	.225	.87	.31	
			1H ¹	A75BH11	.500	.500	.31	.90	
WR90 8.20 to 12.40 GHz	90°	.150	1E	C90BE12	.180	.180	1.14	.39	
			2E	C90BE22	.180	.630	1.14	.39	
			3E	C90BE32	.630	.630	1.14	.39	
			1H	C90BH32	.575	.575	.39	1.14	
			2H	C90BH42	.575	1.093	.39	1.14	
			.175	1E	C90BE42	.200	.200	1.10	.37
			1H	C90BH52	.575	.575	.37	1.10	
			.200	1E	A90BE11	.215	.215	1.10	.41
			1E	A90BE111	.180	.180	1.10	.41	
			1E ²	A90BE41	.180	.180	1.02	.32	
	2E ²	A90BE122	.180	.780	1.02	.29			
	2E	A90BE72	.215	1.270	1.10	.41			
	3E	A90BE62	1.270	1.270	1.10	.41			
	4E	A90BE32	.353	.353	1.10	.39			
	1H	A90BH11	.575	.575	.40	1.10			
	1H ²	A90BH41	.575	.575	.32	1.02			
	2H ²	A90BH82	.575	.825	.30	.99			
	2H	A90BH22	.575	.968	.40	1.10			
	3H	A90BH32	.968	.968	.40	1.10			
	45°	.150	4H	C90BH22	.750	-	.39	1.13	
5E ²	A90BE112	.353	-	1.10	.39				
.200	5E	A90BE52	.353	-	1.10	.39			
4H ²	A90BH52	.750	-	.40	1.10				
4H	A90BH92	.750	-	.40	1.10				
15°	.200	4H	A90BH42	.750	-	.40	1.10		
180°	.200	5H ³	A90BH72	.575	1.543	.40	2.65		

Notes: ¹W/G socket accepts .020 wall W/G
²W/G socket accepts .030 wall W/G
³W/G socket accepts .040 wall W/G

NARROW HEIGHT BENDS

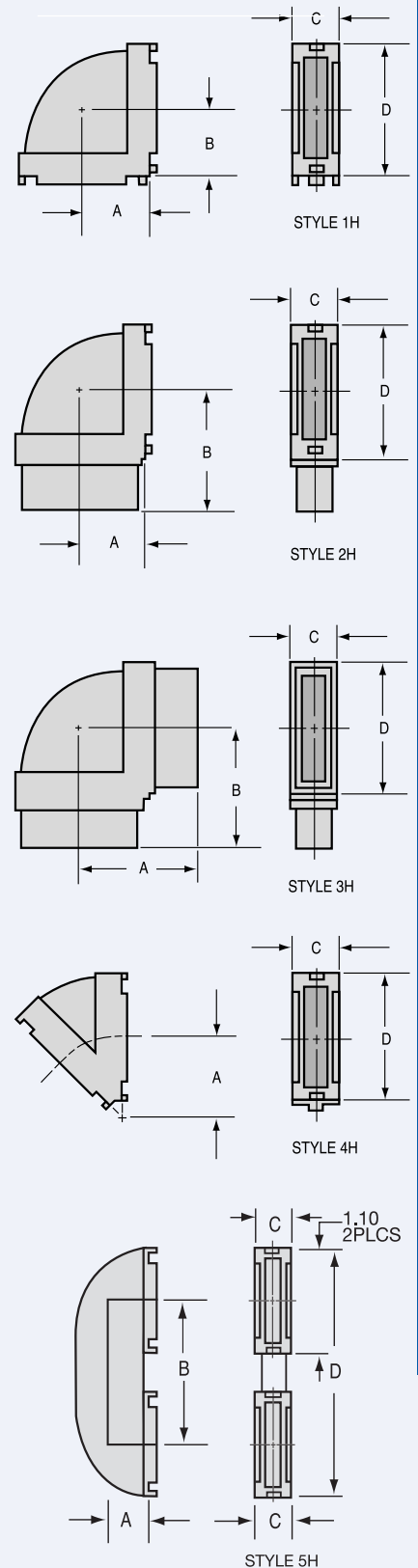

Narrow Height Bends

NARROW HEIGHT BENDS

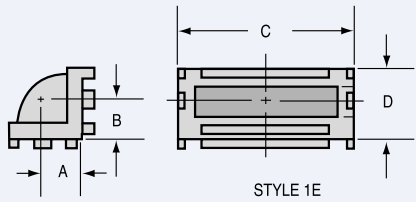

STYLE 1E

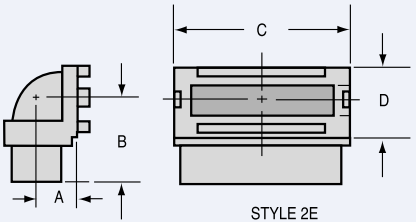

STYLE 2E

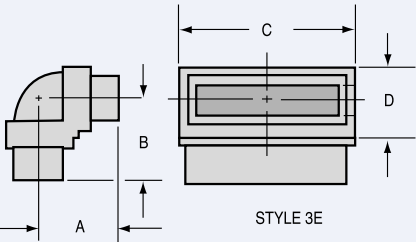

STYLE 3E

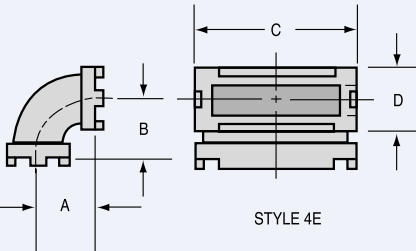

STYLE 4E

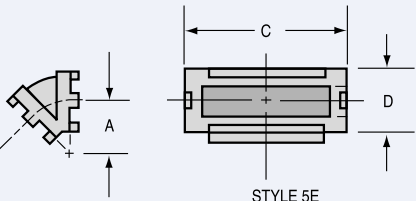

STYLE 5E

W/G Size Freq GHz	Degree	Height ID	Style	Model Number	Dimensions			
					A	B	Ref C	Ref D
WR102 7.00 to 11.00 GHz	90°	.255	1E	A102BE102	.250	.250	1.26	.50
			1H	A102BH72	.640	.640	.50	1.26
WR137 5.85 to 8.20 GHz	90°	.248	1E	A137BE12	.200	.200	1.60	.48
			2E	A137BE22	.200	.470	1.60	.48
WR159 4.90 to 7.00 GHz	90°	.397	1E	A159BE12	.400	.400	1.82	.62
			1H	A159BH12	1.000	1.000	.62	1.82
WR284 2.60 to 3.95 GHz	90°	.400	1E	A284BE22	.310	.310	3.13	.75
			2E	A284BE12	.310	.490	3.13	.75
			1H	A284BH22	1.531	1.531	.80	3.15
			2H	A284BH21	1.530	1.860	1.07	3.25
	45°	.670	1E	A284BE32	.460	.460	3.24	1.12
			2E	A284BE62	.460	2.160	3.22	1.08
			1H	A284BH11	1.530	1.530	1.07	3.25
			2H	A284BH21	1.530	1.860	1.07	3.25
			5E ³	A284BE42	.927	-	3.00	.83
			5E	A284BE72	.927	-	.32	1.03
			4H	A284BH32	1.677	-	.83	3.00

Formed Bends

MDL's line of waveguide formed bends, twists, and offsets cover band sizes WR15 through WR284 with radius from .25 inches to 18.0 inches in .12 inch increments.

Single and multiple E and H bends, twists and offsets may be ordered in the following waveguide material: OFHC, Copper, Brass, Aluminum, and Coin Silver. More difficult forms, which do not lend themselves readily to the bending process, can be electroformed or developed into a precision cast unit.

W/G Size Freq GHz	W/G Size O.D. Inches	E Bend Throat Radius (R)	H Bend Throat Radius (R)
WR28 26.5 to 40.0 GHz	0.360 x 0.220	.31	.43
		.50	.75
		.56	-
WR42 18.0 to 26.5 GHz	0.500 x 0.250	.75	.75
WR51 15.0 to 22.0 GHz	0.590 x 0.335	-	.25
		.57	.37
		1.37	1.00
WR62 12.4 to 18.0 GHz	0.702 x 0.391	.25	.15
		.30	.25
		.37	.31
		.56	.50
		.68	.62
		.75	.75
		.87	1.00
		1.25	1.09
		1.75	1.25
		2.00	1.50
WR75 10.0 to 15.0 GHz	0.850 x 0.475	.50	-
		1.25	.87
		2.00	1.25
WR90 8.20 to 12.40 GHz	1.000 x 0.500	.25	.25
		.37	.37
		.43	.50
		.50	1.00
		.62	2.00
		.69	2.50
		.75	2.75
		1.00	3.00
		1.25	-
		1.50	-
2.00	-		
2.50	-		
WR90 8.2 to 12.4 GHz	1.000 x .300 O.D.	-	.37
	1.000 x .200 I.D.	-	.50
WR102 7.00 to 11.0 GHz	1.148 x 0.638	.75	2.00
WR112 7.05 to 10.0 GHz	1.250 x 0.625	.37	.43
		.50	.62
		.75	.75
		1.50	1.37
		2.75	2.00
-	2.75	-	
WR137 5.85 to 8.20 GHz	1.500 x 0.750	1.00	1.00
-	-	-	2.00
WR187	2.000 x 1.000	-	.75

FORMED BENDS

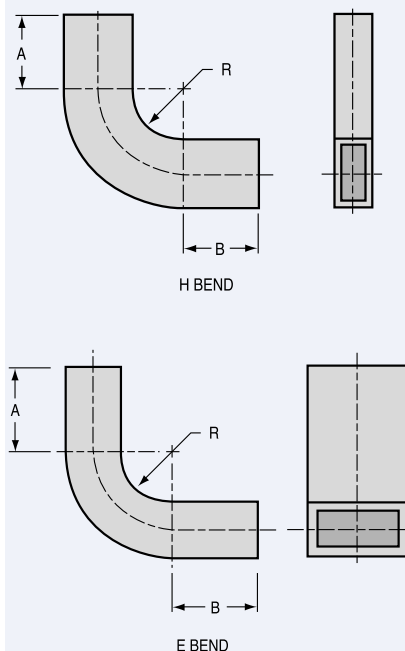

Waveguide Twist

MDL compliments its broad line of cast components with a new high performance cast twist.

A full 90° right hand waveguide twist is provided in a minimal length (approximately 3/4 of wavelength at mid-band). A graded effect in the broadwall design produces very low reflections. VSWR is 1.05 max for casting, and 1.10 for twists and flanges. Power handling capacity is approximately 90% of standard waveguide rating.

FORMED BENDS

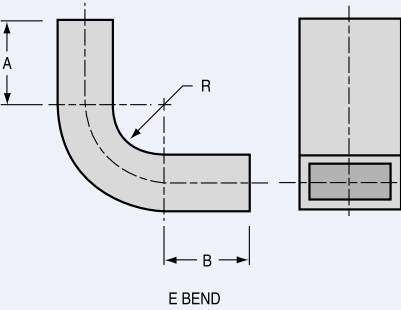
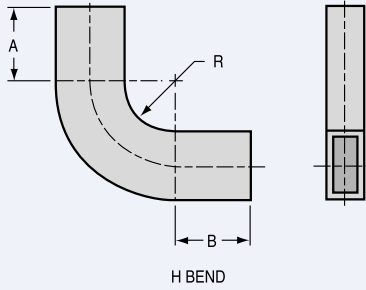

WAVEGUIDE TWISTS

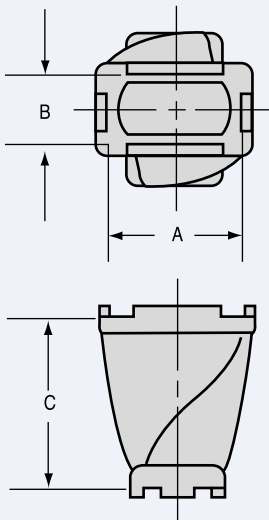

W/G Size	Freq. GHz	Model Number	A	Dimensions B	C
WR22	33.0-50.0	22TW12	.306	.194	.292
WR28	26.5-40.0	28TW12	.362	.222	.408
WR34	22.0-33.0	34TW12	.422	.252	.500
WR42	18.00-26.50	42TW12	.502	.252	.625
WR51	15.00-22.00	51TW12	.592	.337	.750
WR62	12.40-18.00	62TW12	.704	.393	.875
WR75	10.00-15.00	75TW12	.852	.477	1.000
WR90	8.20-12.40	90TW12	1.002	.502	1.250
WR102	7.00-11.00	102TW12	1.150	.640	1.375
WR112	7.05-10.00	112TW12	1.252	.627	1.437
WR137	5.85-8.20	137TW12	1.503	.753	1.750
WR187	3.95-5.85	187TW12	2.004	1.004	2.500
WR284	2.60-3.95	284TW12	3.004	1.504	4.000

Twist with Flanges

W/G Size	Freq GHz	Model Number	Dimensions (D)
WR42	18.00-26.50	42TW18	1.30
WR51	15.00-22.00	51TW18	1.52
WR62	12.40-18.00	62TW18	1.75
WR75	10.00-15.00	75TW18	2.10
WR90	8.20-12.40	90TW18	2.30
WR102	7.00-11.00	102TW18	2.60
WR112	7.05-10.00	112TW18	2.90
WR137	5.85-8.20	137TW18	3.50
WR187	3.95-5.85	187TW18	4.60
WR284	2.60-3.95	284TW18	7.50

TWISTS WITH FLANGES

