

SPEC SHEET

DCF2540-T0040

0.94 GHz to 0.96 GHz

DCF Drop-in ISOLATORS & CIRCULATORS

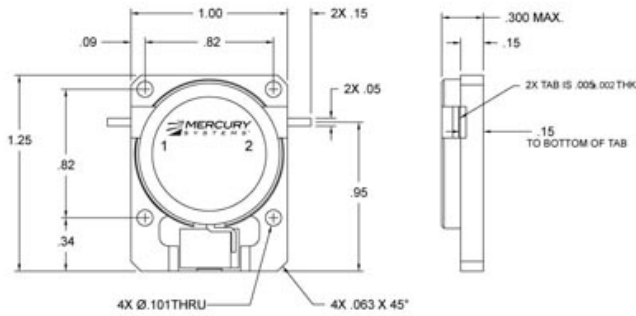

Specifications

RF Frequency	0.94 GHz to 0.96 GHz
Isolation	22 dB (min)
Insertion Loss	0.3 dB (max)
VSWR	1.2:1
Peak Power	1000 Watts (max)
Average Power	100 Watts (max)
Power Forward	150 Watts
Power Reverse	65 Watts
Package Size	1.00 x 1.25 x 0.30"

Environmental

Operating Temperature	-20 to 85 °C
-----------------------	--------------

Notes



MERCURY COMMERCIAL ELECTRONICS

Microwave RF Components | Manteca, CAL | 1-209-825-3977 | rf.mrcy.com
 Specifications subject to change without notice

