

# BIAS TEES

Type N, up to 12 GHz, 100 Volts / 2.5 Amps

**RoHS**  
Compliant

## SPECIFICATIONS:

Models: 8800NMFx-yy, 8800NFFx-yy, 8800NMMx-yy, 8800NFMx-yy

<b>Electrical:</b>			
Frequency Range	10 MHz - 12 GHz		
Standard Freq. Values	2.5, 4, 6, 9 & 12 GHz		
Insertion Loss	Typical	Maximum	
10 MHz - 30 MHz	1.00 dB	1.25 dB	
30 MHz - 2.5 GHz	0.50 dB	1.00 dB	
2.5 - 6 GHz	1.00 dB	1.25 dB	
6 - 9 GHz	1.50 dB	2.00 dB	
9 - 12 GHz	2.00 dB	3.00 dB	
VSWR	Typical	Maximum	
30 MHz - 2.5 GHz	1.40:1	1.50:1	
2.5 GHz - 4 GHz	1.30:1	1.50:1	
4 - 6 GHz	1.40:1	1.50:1	
6 - 9 GHz	1.50:1	1.80:1	
9 - 12 GHz	1.75:1	2.00:1	
Isolation (RF to Bias Port)	> 30dB Typ.		
3dB Bandwidth	5 MHz - 15 GHz		
Impedance	50 Ohms		
Bias-Path Resistance	0.04 Ohms Typ., 0.05 Ohms Max.		
DC Voltage	100 VDC Max.		
DC Current	2.5 Amps Max.		
RF Power	5 Watts Max		
Current Rating vs Temperature	See Graph		
<b>Environmental</b>			
Operating Temperature Range	-55°C to +105°C		
Storage Temperature Range	-60°C to +90°C		
<b>Mechanical:</b>			
Type N & SMA Connectors	Passivated Stainless Steel		
Mates with MIL-STD-348			
BNC Connectors	Nickel Plated Brass		
Mates with MIL-STD-348			
Conductors	Gold Plated Beryllium Copper		
Body	Aluminum with Chemical Conversion Coating		



Typical performance from 5 MHz - 9 GHz

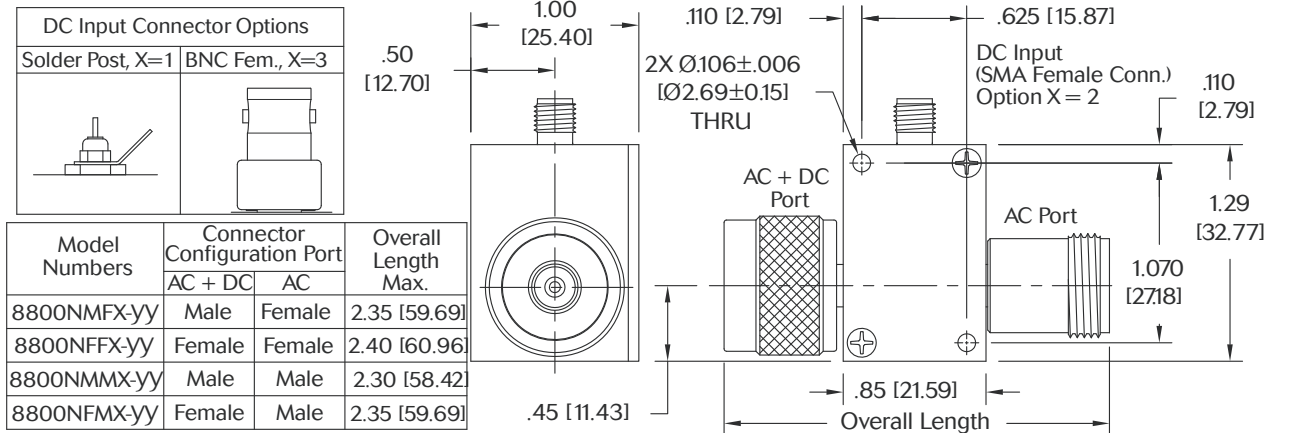
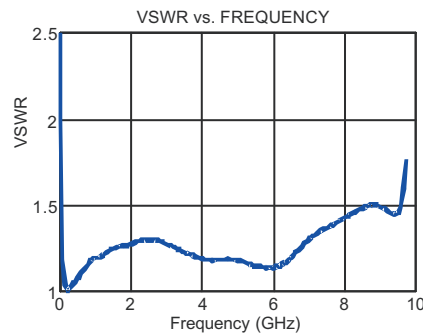
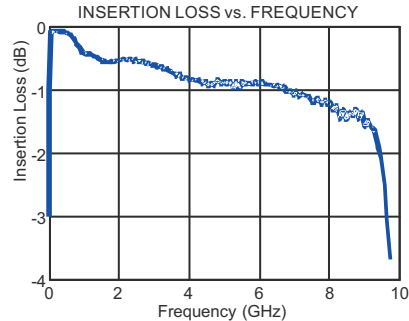

## HOW TO ORDER:

Model Number: **8800NZZX-yy**

Base Number | Freq. Range  
 DC Connector Type |  
 1 = Solder Post | 02 = 10 MHz - 2.5 GHz  
 2 = SMA Female Conn. | 04 = 10 MHz - 4 GHz  
 3 = BNC Female Conn. | 06 = 10 MHz - 6 GHz  
 | 09 = 10 MHz - 9 GHz  
 | 12 = 10 MHz - 12 GHz

## Ordering Examples:

Model Number: **8800NFF2-02**  
 10 MHz - 2.5 GHz, Type N Fem/Fem  
 SMA Female DC Connector Type

Model Number: **8800NMF1-06**  
 10 MHz - 6 GHz, Type N Male/Fem  
 Solder Post DC Connector Type

Note: Dimensions in Brackets are Expressed in Millimeters and are for Reference Only.  
 Design specifications are subject to change without notice.  
 Contact factory for technical specifications before purchasing or use.

8800N: REV E



Aeroflex / Inmet, Inc. • 300 Dino Drive, Ann Arbor, MI 48103 • U.S.A.  
 888-244-6638 or 734-426-5553 • FAX: 734-426-5557  
 www.aeroflex.com/inmet • inmet@aeroflex.com

PROPRIETARY NOTICE  
 THE INFORMATION CONTAINED  
 IN THIS DRAWING IS PROPRIETARY  
 AND SHALL NOT BE USED OR  
 DISCLOSED WITHOUT THE PRIOR  
 WRITTEN PERMISSION OF  
 AEROFLEX/INMET INC.

REVISIONS			
LTR	DESCRIPTION	DATE	DCN NO.
D	SEE REVISION HISTORY	2/27/07	06-00708

ADDITIONAL INFORMATION

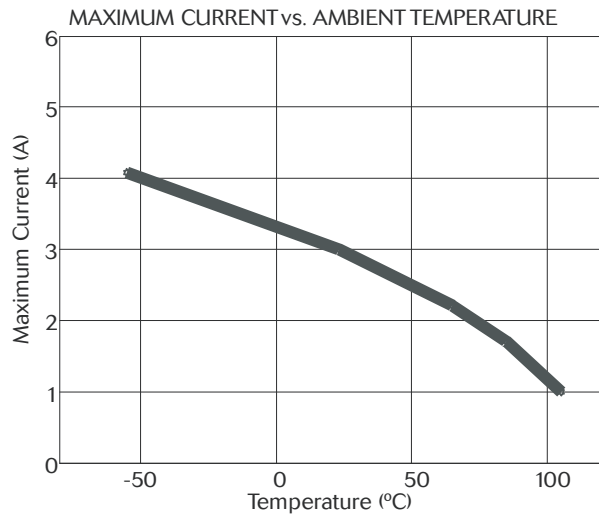
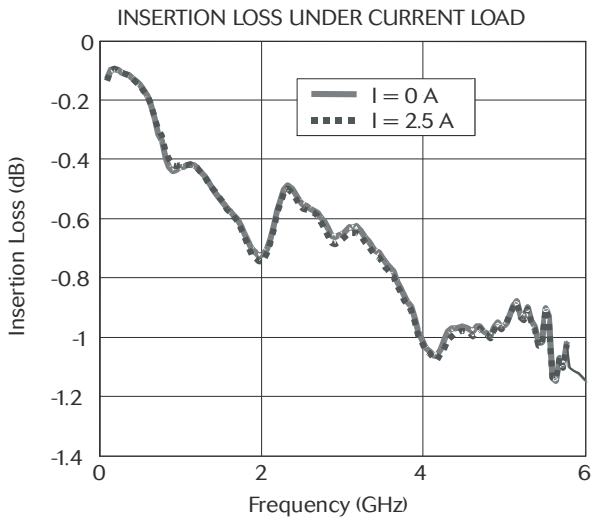
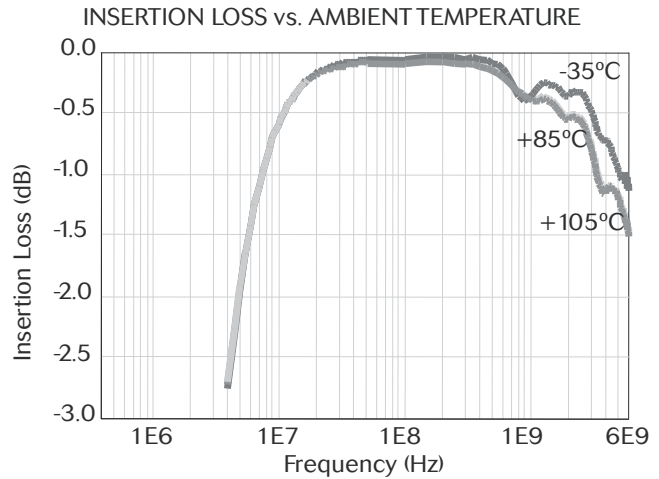
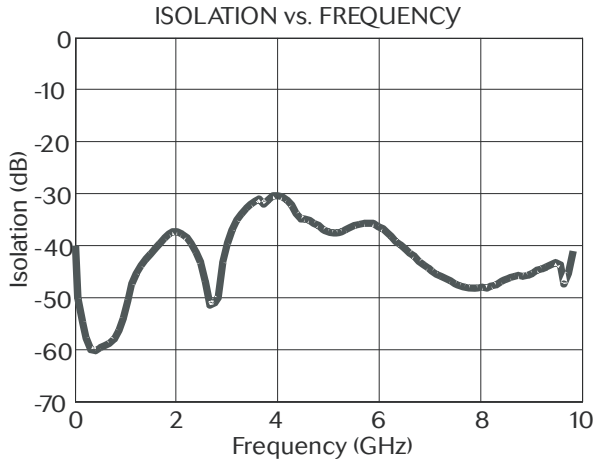

NOTE: DIMENSIONS IN BRACKETS ARE EXPRESSED IN MILLIMETERS AND ARE FOR REFERENCE ONLY.

UNLESS OTHERWISE SPECIFIED DIMENSIONS ARE IN INCHES TOLERANCES DECIMAL      ANGULAR .XX ± .01      ± .XXX ± .005 DO NOT SCALE DRAWING	CONTRACT NO.			300 DINO DRIVE ANN ARBOR, MI 48103 TELEPHONE (734) 426-5553 FACSIMILE (734) 426-5557		
	CHECKED	DATE		TITLE:                      OUTLINE DRAWING, BIAS TEE, Type N CONNECTORS 10 MHz - 12 GHz, 50 OHM 8800NXXZ-YY SERIES		
	EJM	10/10/02				
	ENGINEERING	DATE				
	EA	10/11/02				
MATERIAL:	MANUFACTURING	DATE	SIZE	FSCM NO.	DWG. NO.	
	RB	10/25/02	A	64671	8800N	
FINISH	QUAL. ASSURANCE	DATE	SCALE		RELEASE DATE	
	RFF	10/11/02	FULL			
SIMILAR TO	WEIGHT (gr)	MARKETING	DATE		SHEET 2 OF 2	
		NH	10/24/02			