

Analog Devices Welcomes Hittite Microwave Corporation

NO CONTENT ON THE ATTACHED DOCUMENT HAS CHANGED



THIS PAGE INTENTIONALLY LEFT BLANK

GaAs pHEMT MMIC 2 WATT POWER AMPLIFIER WITH POWER DETECTOR, 12 - 16 GHz

Typical Applications

The HMC5846LS6 is ideal for:

- Point-to-Point Radios
- Point-to-Multi-Point Radios
- VSAT & SATCOM
- Military & Space

Features

- Saturated Output Power: 35.5 dBm @ 30% PAE
- High Output IP3: 42.5 dBm
- High Gain: 31 dB
- DC Supply: +7V @ 1200 mA
- No External Matching Required

Functional Diagram

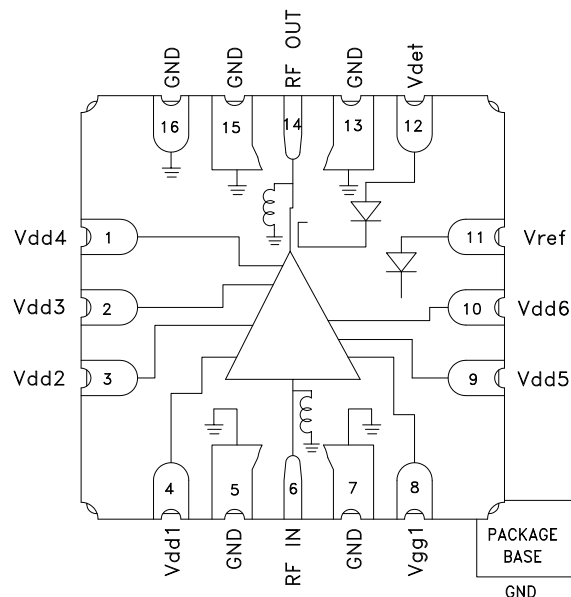

General Description

The HMC5846LS6 is a 4 stage GaAs pHEMT MMIC 2 Watt Power Amplifier with an integrated temperature compensated power detector which operates between 12 and 16 GHz. The HMC5846LS6 provides 31 dB of gain, 35.5 dBm of saturated output power, and 30% PAE from a +7V supply. The HMC5846LS6 exhibits excellent linearity and is optimized for high capacity digital microwave radio. It is also ideal for 13.75 to 14.5 GHz Ku Band VSAT transmitters as well as SATCOM applications.

Electrical Specifications, $T_A = +25^\circ\text{C}$

$V_{dd} = V_{dd1}, V_{dd2}, V_{dd3}, V_{dd4}, V_{dd5} = +7V, I_{dd} = 1200\text{ mA}$ [1]

Parameter	Min.	Typ.	Max.	Units
Frequency Range	12 - 16			GHz
Gain	26	31		dB
Gain Variation Over Temperature		0.06		dB/ °C
Input Return Loss		10		dB
Output Return Loss		17		dB
Output Power for 1 dB Compression (P1dB)	32.5	34.5		dBm
Saturated Output Power (P _{sat})		35.5		dBm
Output Third Order Intercept (IP ₃) ^[2]		42.5		dBm
Total Supply Current (I _{dd})		1200		mA

[1] Adjust V_{gg} between -2 to 0V to achieve I_{dd} = 1200 mA typical.

[2] Measurement taken at +7V @ 1200 mA, P_{out} / Tone = +22 dBm



GaAs pHEMT MMIC 2 WATT POWER AMPLIFIER WITH POWER DETECTOR, 12 - 16 GHz

Broadband Gain & Return Loss vs. Frequency

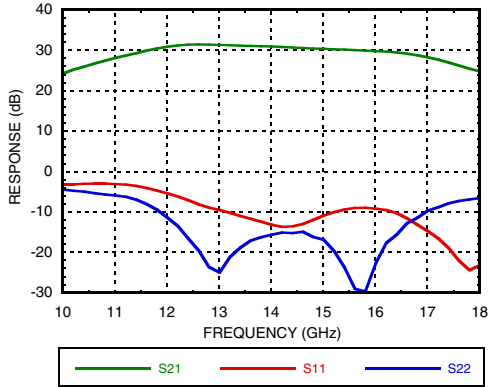

Gain vs. Temperature

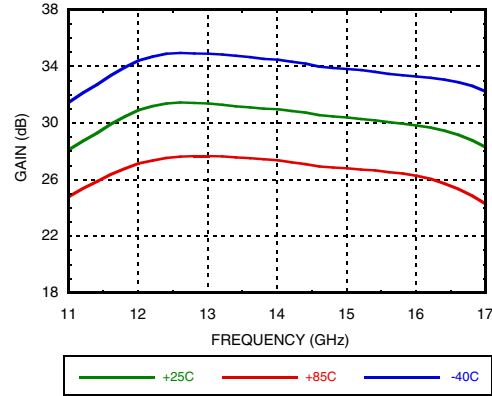

Input Return Loss vs. Temperature

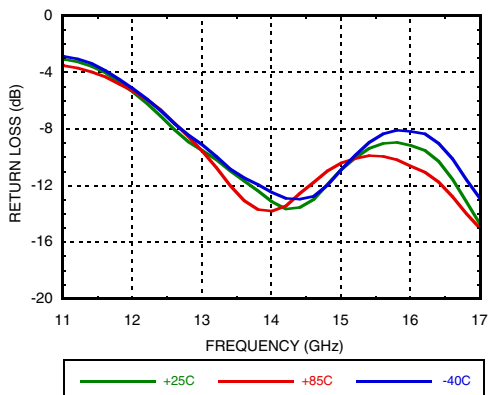

Output Return Loss vs. Temperature

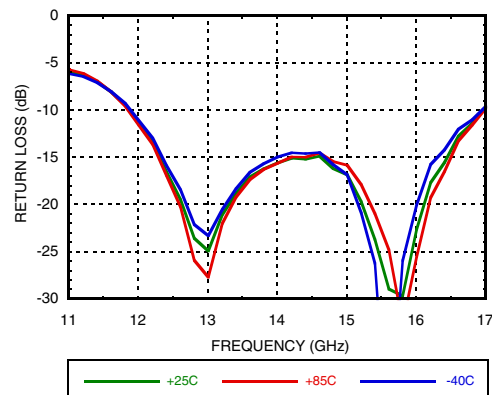

P1dB vs. Temperature

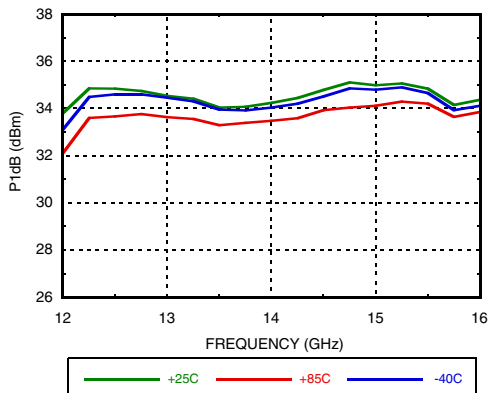

P1dB vs. Supply Voltage

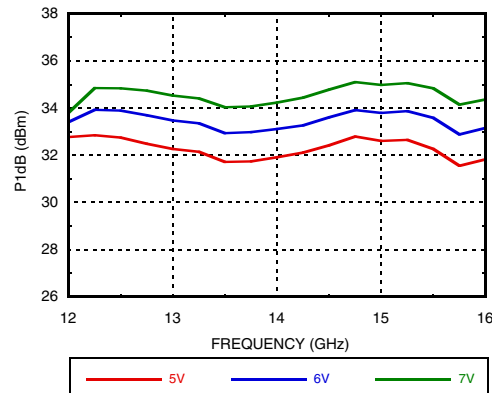



GaAs pHEMT MMIC 2 WATT POWER AMPLIFIER WITH POWER DETECTOR, 12 - 16 GHz

AMPLIFIERS - LINEAR & POWER - SMT

Psat vs. Temperature

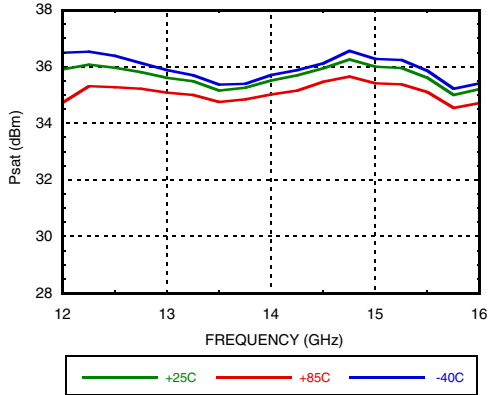

Psat vs. Supply Voltage

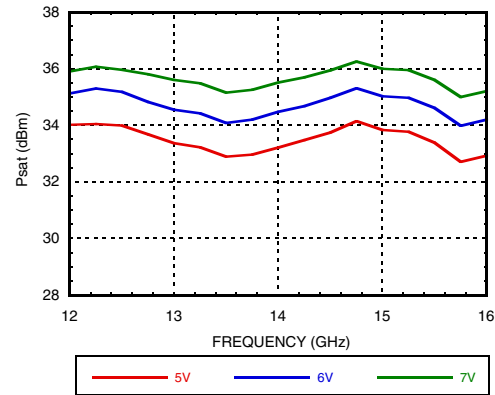

P1dB vs. Supply Current (Idd)

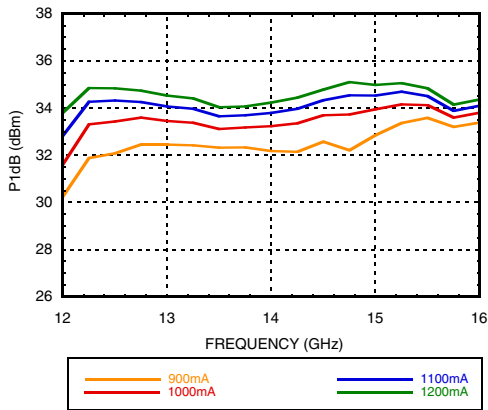

Psat vs. Supply Current (Idd)

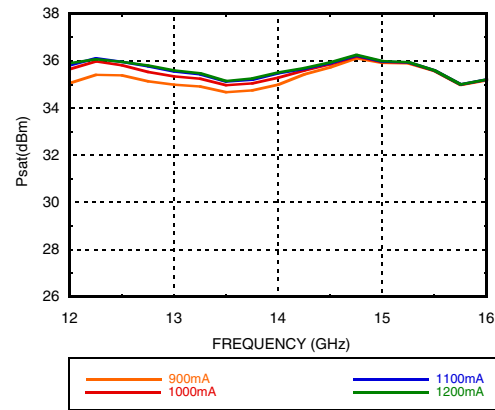

Output IP3 vs. Temperature, Pout/Tone = +22 dBm

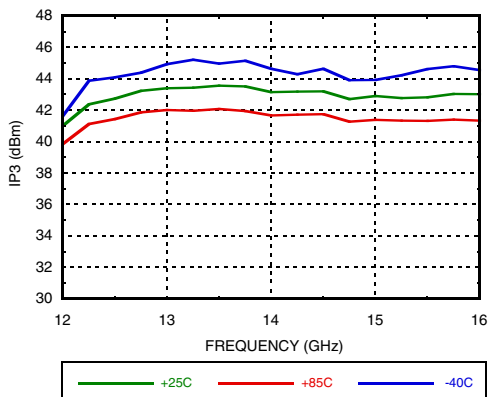

Output IP3 vs. Supply Current, Pout/Tone = +22 dBm

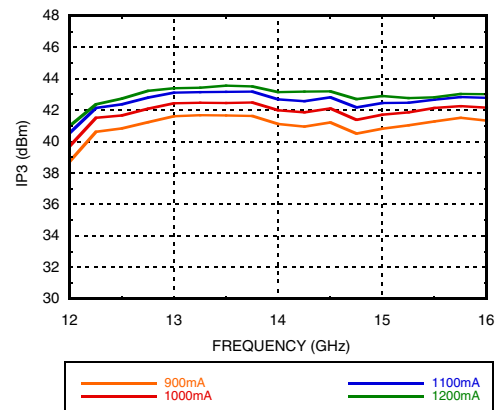

[1] Footnote if needed



GaAs pHEMT MMIC 2 WATT POWER AMPLIFIER WITH POWER DETECTOR, 12 - 16 GHz

Output IP3 vs. Supply Voltage, Pout/Tone = +22 dBm

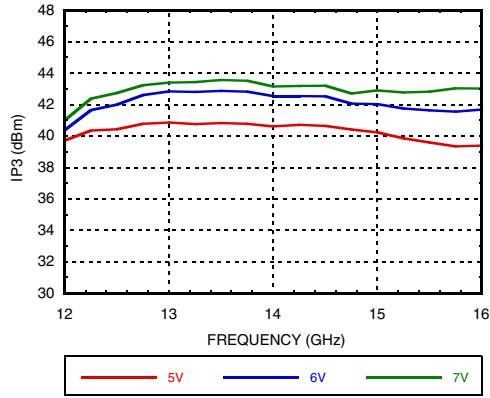

Output IM3 @ Vdd = +5V

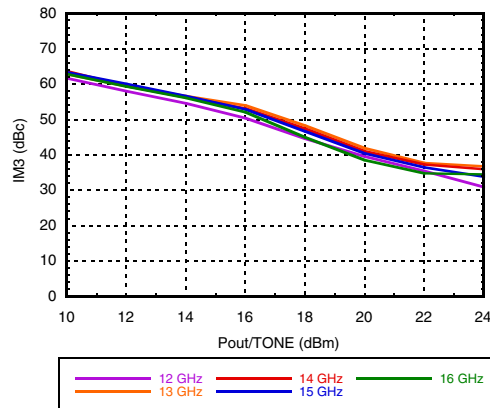

Output IM3 @ Vdd = +6V

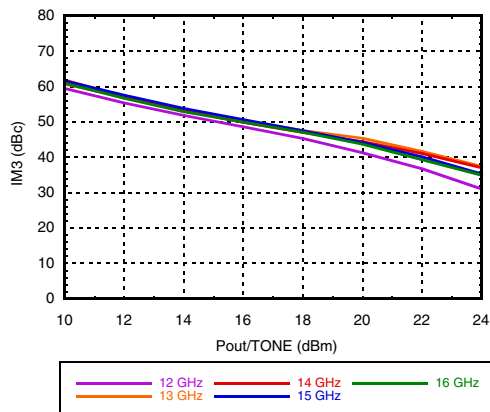

Output IM3 @ Vdd = +7V

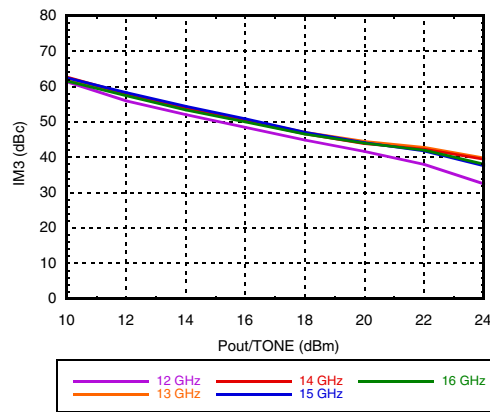

Power Compression @ 13 GHz

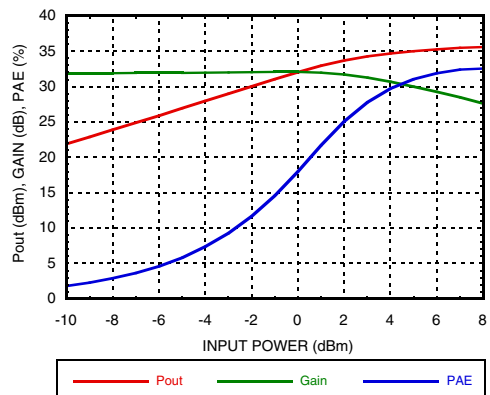

Power Compression @ 14 GHz

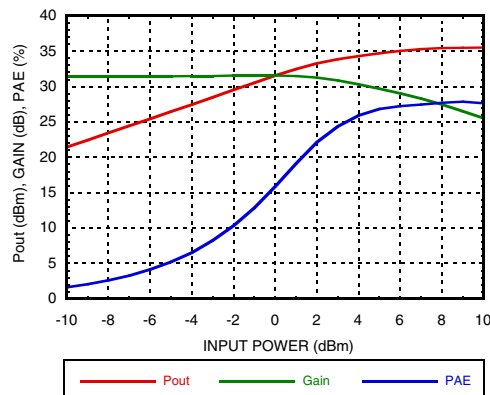



GaAs pHEMT MMIC 2 WATT POWER AMPLIFIER WITH POWER DETECTOR, 12 - 16 GHz

AMPLIFIERS - LINEAR & POWER - SMT

Power Compression @ 15 GHz

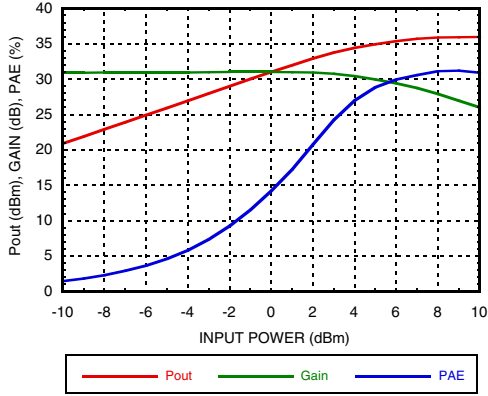

Detector Voltage Over Temperature

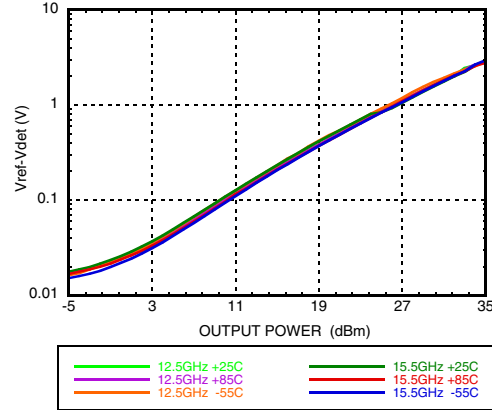

Reverse Isolation vs. Temperature

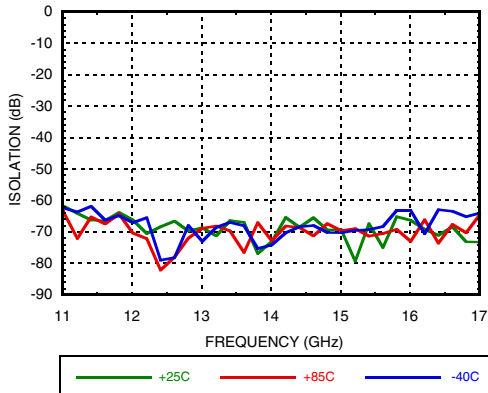

Gain & Power vs. Supply Current @ 14 GHz

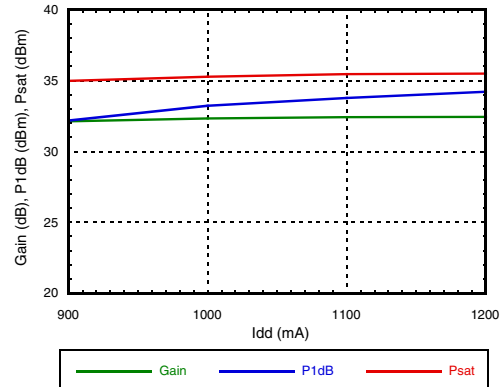

Gain & Power vs. Supply Voltage @ 14 GHz

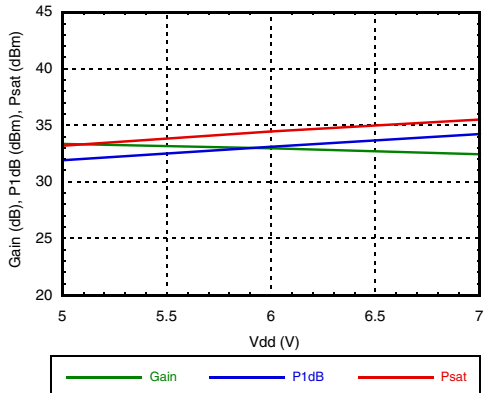

Power Dissipation

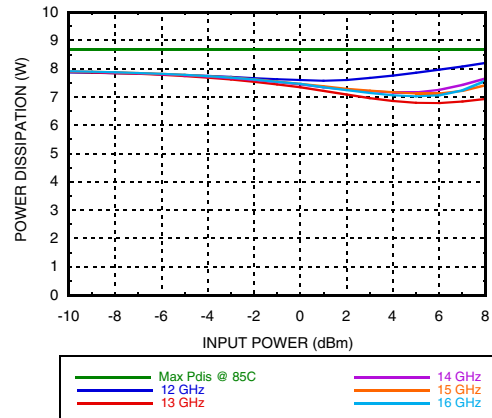



GaAs pHEMT MMIC 2 WATT POWER AMPLIFIER WITH POWER DETECTOR, 12 - 16 GHz

Absolute Maximum Ratings

Drain Bias Voltage (Vdd)	+8V
RF Input Power (RFIN)	+24 dBm
Channel Temperature	150 °C
Continuous Pdiss (T= 85 °C) (derate 133 mW/°C above 85 °C)	8.6 W
Thermal Resistance (channel to ground paddle)	7.55 °C/W
Storage Temperature	-65 to +150 °C
Operating Temperature	-55 to +85 °C
ESD Sensitivity (HBM)	Class 1A Pass 250V

Reliability Information

Junction Temperature to Maintain 1 Million Hour MTTF	150 °C
Nominal Junction Temperature (T= 85 °C and Pin = 10 dBm)	90 °C
Operating Temperature	-55 to +85 °C



ELECTROSTATIC SENSITIVE DEVICE
OBSERVE HANDLING PRECAUTIONS

Outline Drawing

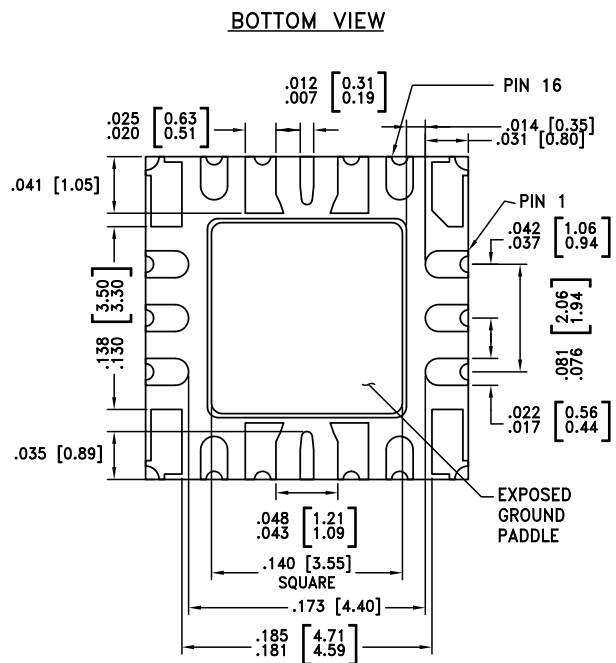
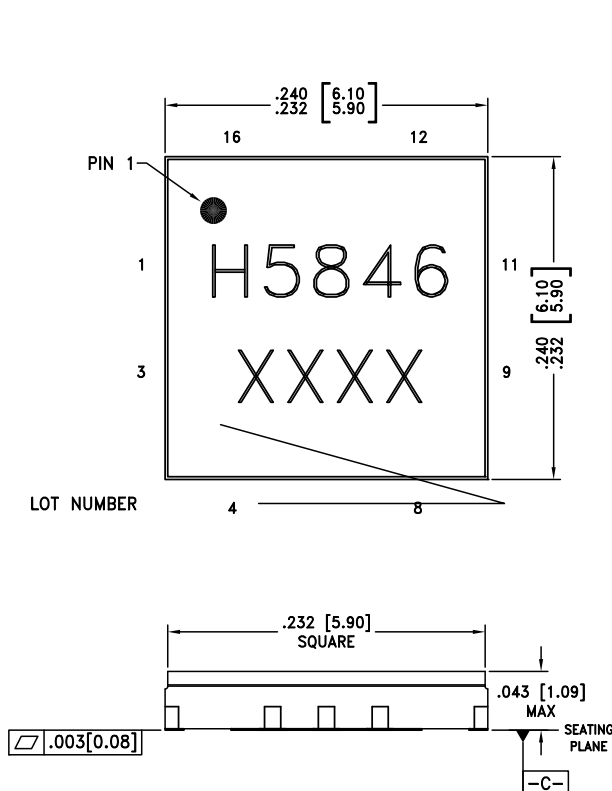

Package Information

Part Number	Package Body Material	Lead Finish	MSL Rating [2]	Package Marking [1]
HMC5846LS6	ALUMINA WHITE	Gold over Nickel	N/A	H5846 XXXX



[1] 4-Digit lot number XXXX

[2] Max peak reflow temperature of 260 °C

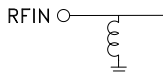
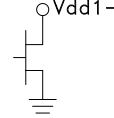

GaAs pHEMT MMIC 2 WATT POWER AMPLIFIER WITH POWER DETECTOR, 12 - 16 GHz

Pin Descriptions

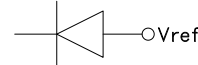
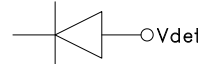
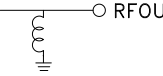
Pad Number	Function	Description	Interface Schematic
6	RFIN	This Pin is DC coupled and matched to 50 Ohms over the operating frequency.	
1-4 9, 10	Vdd4, Vdd3, Vdd2, Vdd1, Vdd5, Vdd6	Drain bias voltage for the amplifier. External bypass capacitors of 100 pF are required for each pin followed by 0.01 μF capacitors and a 4.7 μF capacitors.	
8	Vgg1	Gate controlled amplifier. External bypass capacitors of 100 pF are required followed by 0.01 μF capacitors and a 4.7 μF capacitors.	
5, 7, 13, 15, 16	GND	These Pins and Package bottom must be connected to RF/DC ground.	
11	Vref	DC voltage of diode biased through external resistor, used for temperature compensation of Vdet.	
12	Vdet	DC voltage representing RF output rectified by diode which is biased through an external resistor.	
14	RFOUT	This Pin is DC coupled and matched to 50 Ohms.	

Application Circuit

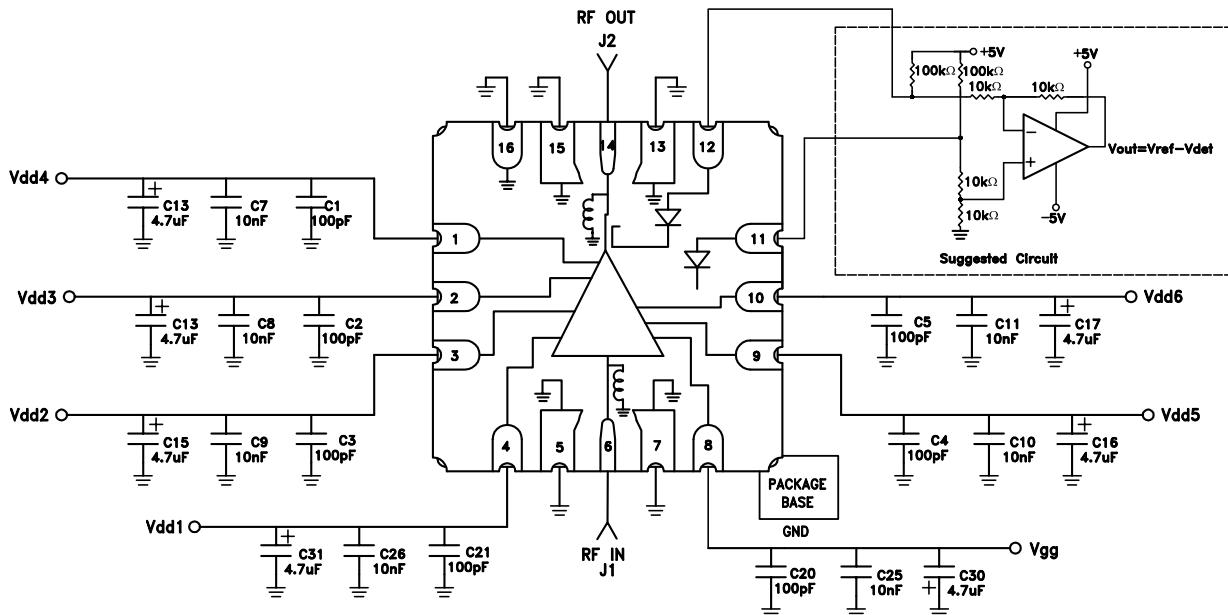

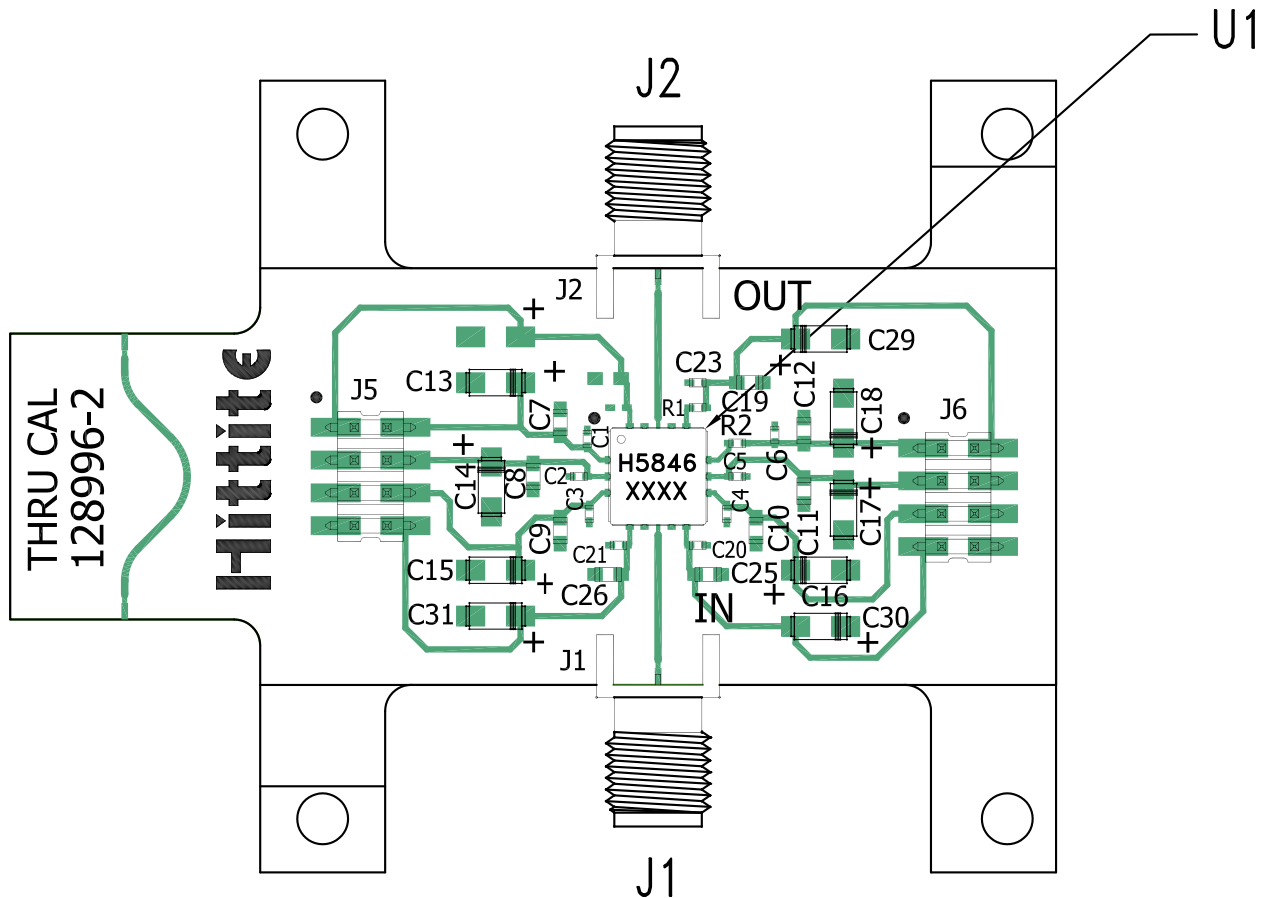
**GaAs pHEMT MMIC 2 WATT POWER AMPLIFIER
 WITH POWER DETECTOR, 12 - 16 GHz**
Evaluation PCB

List of Materials for Evaluation PCB EVAL01-HMC5846LS6 [1]

Item	Description
J1, J2	PCB Mount K Connectors, SRI
J5, J6	DC Pins
C1 - C6, C20, C21, C23	100 pF Capacitors, 0402 Pkg.
C7 - C12, C19, C25, C26	0.01 μ F Capacitors, 0603 Pkg.
C13 - C18, C29 - C31	4.7 μ F Capacitors, Case A Pkg.
R1 - R2	40.2 kOhm Resistor, 0402 Pkg.
U1	HMC5846LS6 Amplifier
PCB [2]	128996 Evaluation PCB

[1] Reference this number when ordering complete evaluation PCB

[2] Circuit Board Material: Rogers 4350

The circuit board used in the application should use RF circuit design techniques. Signal lines should have 50 Ohm impedance while the package ground leads and exposed paddle should be connected directly to the ground plane similar to that shown. A sufficient number of via holes should be used to connect the top and bottom ground planes. The evaluation board should be mounted to an appropriate heat sink. The evaluation circuit board shown is available from Hittite upon request.