

Analog Devices Welcomes Hittite Microwave Corporation

NO CONTENT ON THE ATTACHED DOCUMENT HAS CHANGED



THIS PAGE INTENTIONALLY LEFT BLANK



GaAs MMIC SPDT NON-REFLECTIVE SWITCH, DC - 20 GHz



Typical Applications

The HMC-C011 is ideal for:

- Basestation Infrastructure
- Fiber Optics & Broadband Telecom
- Microwave Radio & VSAT
- Military Radios, Radar, & ECM
- Test Instrumentation

Functional Diagram

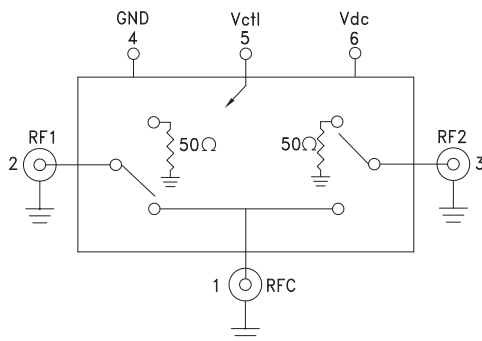

Features

- High Isolation: >45 dB up to 5 GHz
>35 dB up to 20 GHz
- Low Insertion Loss: 2 dB @ 12 GHz
2.5 dB @ 16 GHz

Fast Switching

Non-Reflective Design

Hermetically Sealed Module

Field Replaceable SMA connectors

-55 °C to +85 °C Operating Temperature

General Description

The HMC-C011 is a general purpose broadband high isolation non-reflective GaAs MESFET SPDT switch housed in a miniature hermetic module with field replaceable SMA connectors. Covering DC to 20 GHz, the switch offers high isolation and low insertion loss. The switch features >45 dB isolation up to 5 GHz and >35 dB isolation up to 20 GHz. CMOS interface allows a single positive +5V bias voltage at very low DC currents.

Electrical Specifications, $T_A = +25^\circ\text{C}$, With $V_{dc} = +5\text{V}$ & $0/+5\text{V}$ Control, 50 Ohm System

Parameter	Frequency	Min.	Typ.	Max.	Units
Insertion Loss	DC - 4.0 GHz		1.8	2.3	dB
	DC - 12.0 GHz		2.0	2.5	dB
	DC - 16.0 GHz		2.5	3.5	dB
	DC - 20.0 GHz		4.0	4.9	dB
Isolation	DC - 4.0 GHz	41	46		dB
	DC - 8.0 GHz	35	40		dB
	DC - 20.0 GHz	25	35		dB
Return Loss	"On State"	DC - 12.0 GHz	15		dB
		DC - 20.0 GHz	10		dB
Return Loss RF1, RF2	"Off State"	DC - 10.0 GHz	20		dB
		DC - 15.0 GHz	15		dB
		DC - 20.0 GHz	10		dB
Input Power for 1 dB Compression	0.5 - 20.0 GHz	20	23		dBm
Input Third Order Intercept (Two-Tone Input Power= +7 dBm Each Tone)	0.5 - 10.0 GHz		48		dBm
	0.5 - 20.0 GHz		45		dBm
Switching Characteristics tRISE, tFALL (10/90% RF) tON, tOFF (50% CTL to 10/90% RF)	DC - 20 GHz		1.3		ns
			5.0		ns
Switching Transients	DC - 20 GHz		20		mVpp

For price, delivery, and to place orders, please contact Hittite Microwave Corporation:
20 Alpha Road Chelmsford, MA 01824 Phone: 978-250-3343 Fax: 978-250-3373
Order Online at www.hittite.com

GaAs MMIC SPDT NON-REFLECTIVE SWITCH, DC - 20 GHz

Insertion Loss

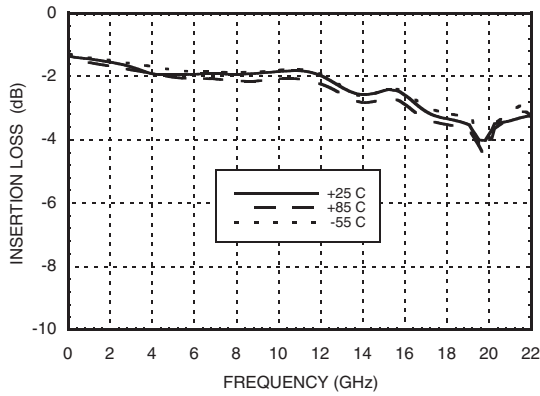

Return Loss

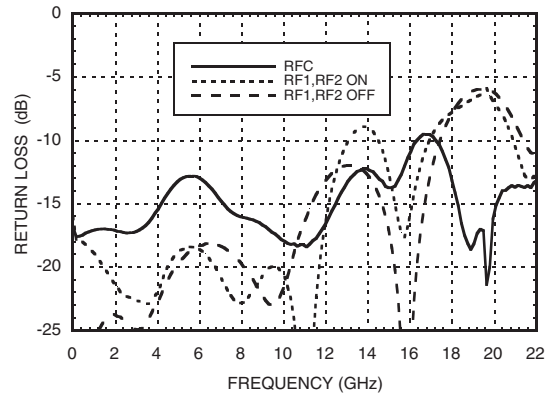

Isolations

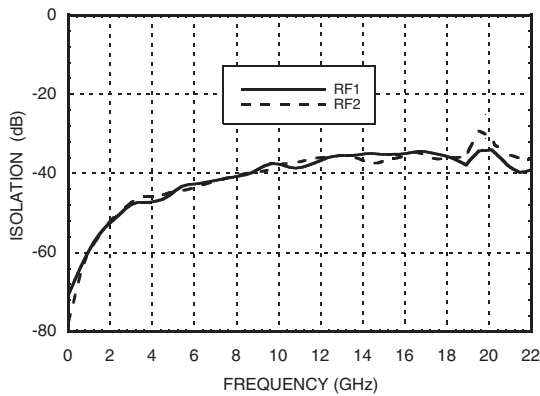

Isolation Between Ports RF1 and RF2

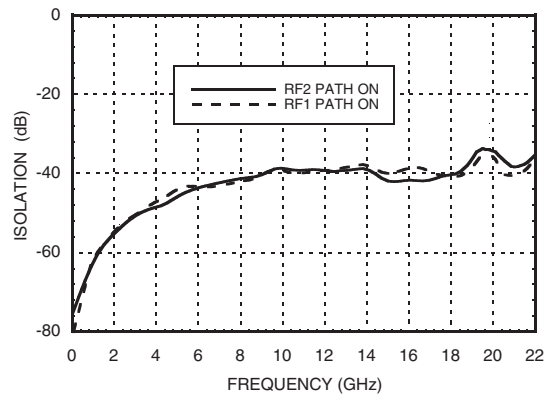

Input P1dB & P0.1dB Compression Point

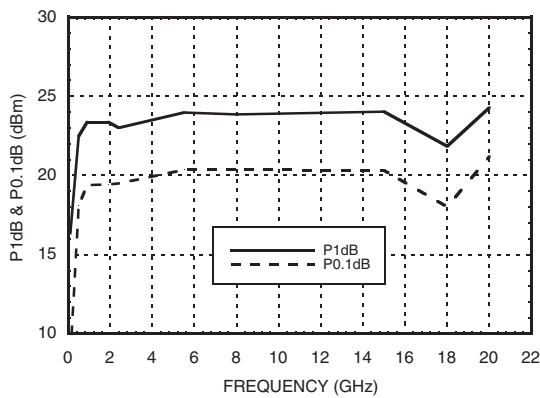

Input Third Order Intercept Point

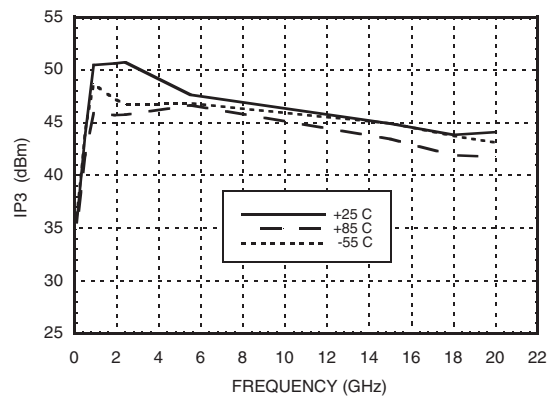

GaAs MMIC SPDT NON-REFLECTIVE SWITCH, DC - 20 GHz
Absolute Maximum Ratings

RF Input Power	+27 dBm
Supply Voltage (Vdc)	+7 Vdc
Control Voltage Range (Vctl)	-0.5V to Vdd +0.5V
Hot Switch Power Level	+23 dBm
Storage Temperature	-65 to +150 °C
Operating Temperature	-55 to +85 °C



**ELECTROSTATIC SENSITIVE DEVICE
OBSERVE HANDLING PRECAUTIONS**

Control Voltages

State	Bias Condition
High	+3.5 to Vdc @ 1 mA Typ.
Low	0 to +1.5V @ 20 μ A Typ.

Truth Table



Control Input	Signal Path State	
	RFC to RF1	RFC to RF2
High	On	Off
Low	Off	On

Bias Voltage & Current

Vdc Range = +5 Vdc \pm 10%	
Vdc (Vdc)	Idc (Typ.) (mA)
+5.0	1.4

(Bias current increases with switching rate to 15 - 20 mA.)

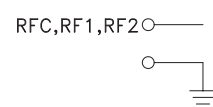
Pin Descriptions

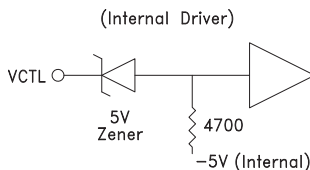
Pin Number	Function	Description	Interface Schematic
1, 2, 3	RFC, RF1, RF2	RF connector, SMA female, field replaceable. These pins are DC coupled and matched to 50 Ohms. DC blocking capacitors are required if external RF line potential is not equal to 0V.	
4	GND	Power supply ground.	
5	Vctl	CMOS interface, control voltages per table. Requires active pullup to +5V (V _{dc}).	
6	Vdc	Supply voltage	

GaAs MMIC SPDT NON-REFLECTIVE SWITCH, DC - 20 GHz



Outline Drawing

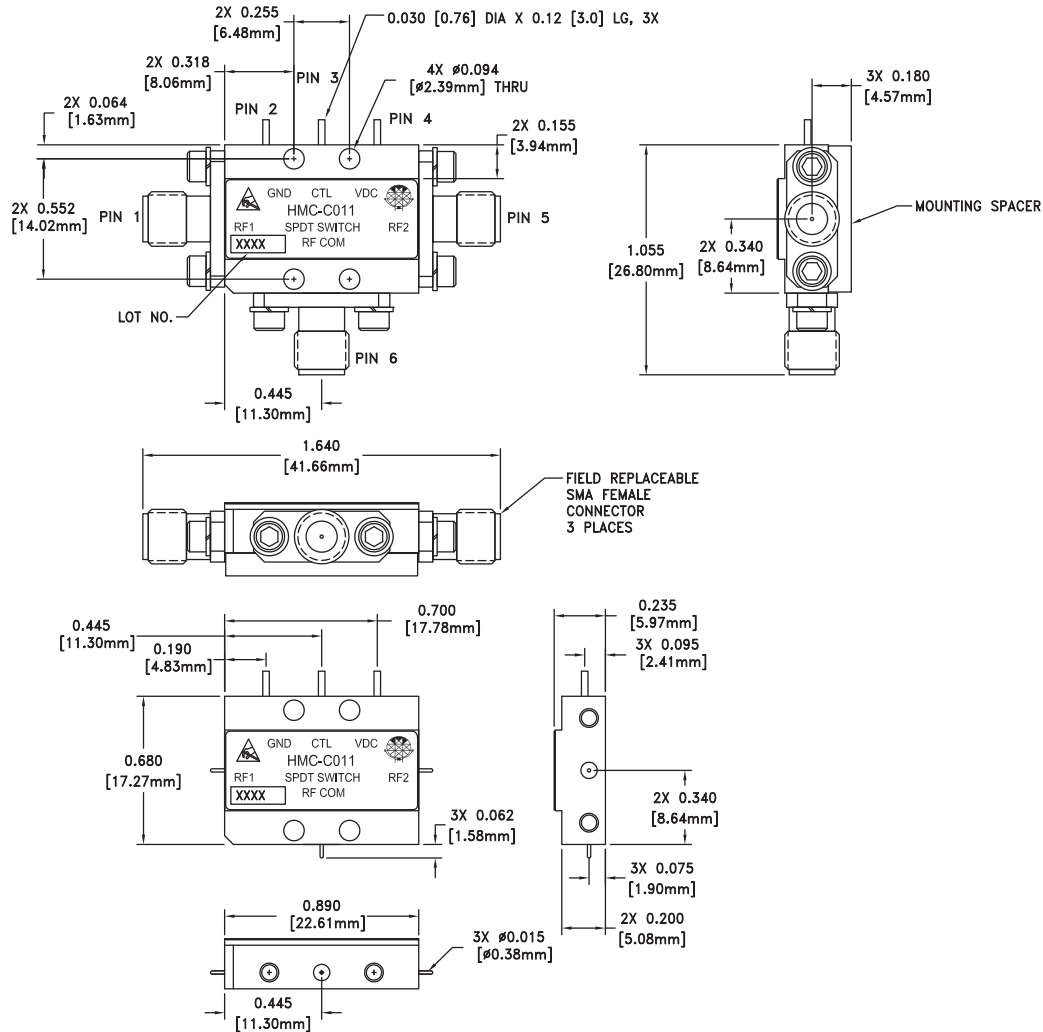

VIEW SHOWN WITH CONNECTORS REMOVED

Package Information

Package Type	C-5
Package Weight [1]	17.7 gms [2]
Spacer Weight	2.6 gms [2]

[1] Includes the connectors

[2] \pm 1 gms Tolerance

NOTES:

1. PACKAGE, LEADS, COVER MATERIAL: KOVAR™
2. FINISH: GOLD PLATE OVER NICKEL PLATE
3. MOUNTING SPACER: NICKEL PLATED ALUMINUM
4. ALL DIMENSIONS ARE IN INCHES [MILLIMETERS]
5. TOLERANCES:
 - 5.1 .XX = \pm 0.02
 - 5.2 .XXX = \pm 0.010
6. FIELD REPLACEABLE SMA CONNECTORS
TENSOLITE 5602 - 5CCSF OR EQUIVALENT
7. TO MOUNT MODULE TO SYSTEM PLATFORM REPLACE 0 - 80
HARDWARE WITH DESIRED MOUNTING SCREWS