

### Typical Applications

The HMC334LP4(E) is ideal for:

- Basestations & Repeaters
- GSM, GPRS & Edge
- CDMA, W-CDMA & TD-SCDMA
- WiMAX & LTE

### Functional Diagram

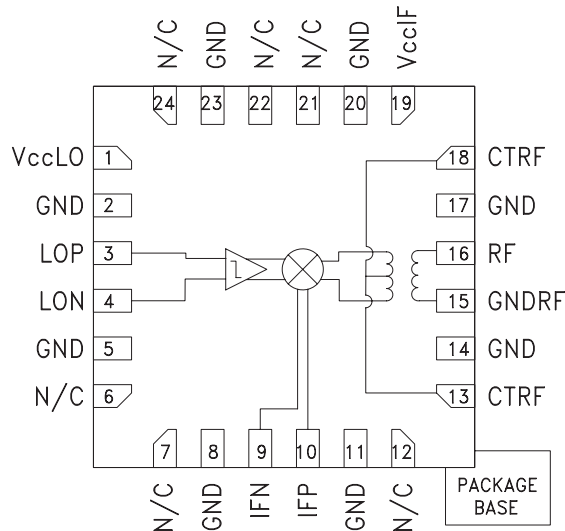

### Features

- Conversion Loss: 0 dB
- LO to RF Isolation: 48 dB
- Single-Ended LO Drive: -6 to +6 dBm
- Input IP3: +26 dBm
- SSB Noise Figure: 11 dB
- On-Chip RF Balun
- 24 Lead 4x4mm QFN Package: 16 mm<sup>2</sup>

### General Description

The HMC334LP4(E) is a low noise, wideband downconverter RFIC which is ideal for Cellular/3G and WiMAX/4G applications from 0.6 to 2.7 GHz. The LO input accepts drive levels from -6 to +6 dBm while the RFIC provides 48 dB of LO to RF isolation, and 0 dB conversion loss. The HMC334LP4(E) will support an IF output bandwidth of up to 600 MHz and consumes only 173 mA from a +5V supply. This wideband active mixer also provides excellent performance in the presence of high level "Blocker" signals, making it ideal for receiver applications in demanding environments.

### Electrical Specifications,

$T_A = +25^\circ\text{C}$ , LO = 0 dBm\*,  $V_{SLO} = V_{SIF} = +5\text{V}$ , IF = 240 MHz

Parameter	Min.	Typ.	Max.	Units
Frequency Range, RF	0.6 - 2.7			GHz
Frequency Range, LO	0.35 - 3.0			GHz
Frequency Range, IF	1 - 600			MHz
Conversion Gain (IF XFMR Included)	-5	-1		dB
SSB Noise Figure		11		dB
LO to RF Isolation	30	48		dB
IF Output Impedance (Diff)		200		Ohms
IP3 (Input)		+26		dBm
1 dB Compression (Input)	8.5	12		dBm
LO Drive Input Level	-6 to +6			dBm
Supply Current		173	225	mA

\*Unless otherwise noted all measurements with  $R_1 = 13\ \Omega$  and single-ended 50 Ohm IF output with Port J2 or J3 shorted to ground.



**SiGe WIDEBAND  
DOWNCONVERTER, 0.6 - 2.7 GHz**

**Conversion Gain vs.  
LO Drive, IF = 100 MHz [1]**

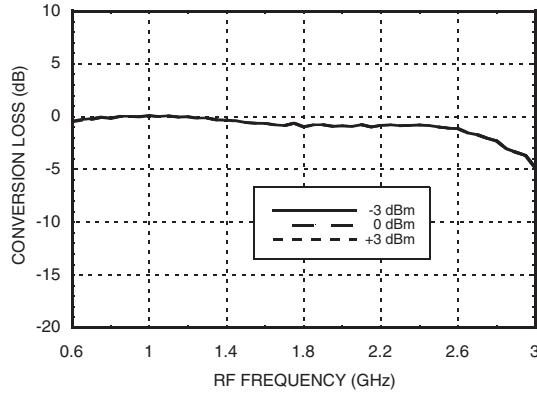

**Conversion Gain vs. Temperature  
@ LO = 0 dBm, IF = 100 MHz [1]**

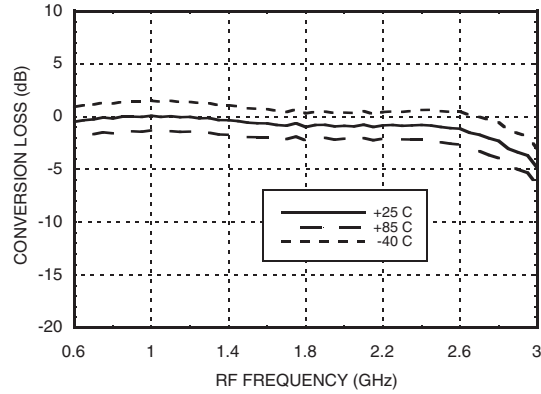

**Conversion Gain vs.  
LO Drive, IF = 240 MHz [1]**

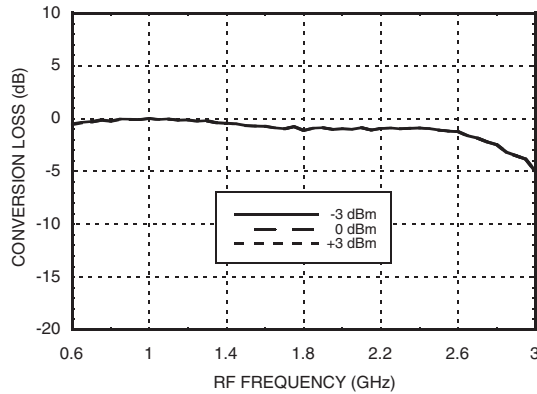

**Conversion Gain vs. Temperature  
@ LO = 0 dBm, IF = 240 MHz [1]**

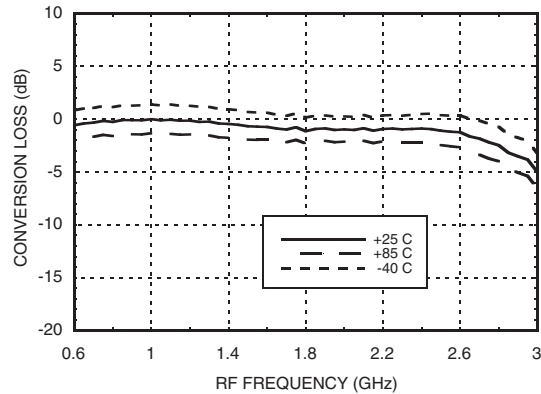

**P1dB vs. Temperature  
@ LO = 0 dBm, IF = 100 MHz [1]**

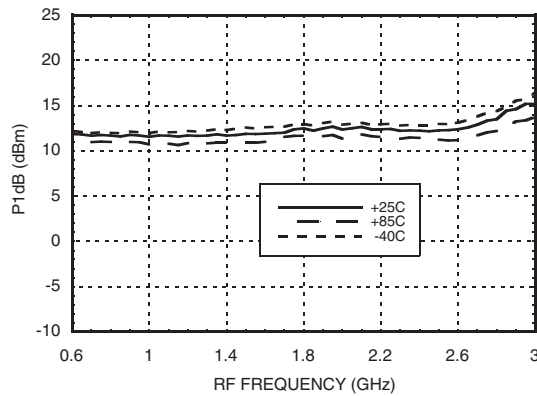

**P1dB vs. Temperature  
@ LO = 0 dBm, IF = 240 MHz [1]**

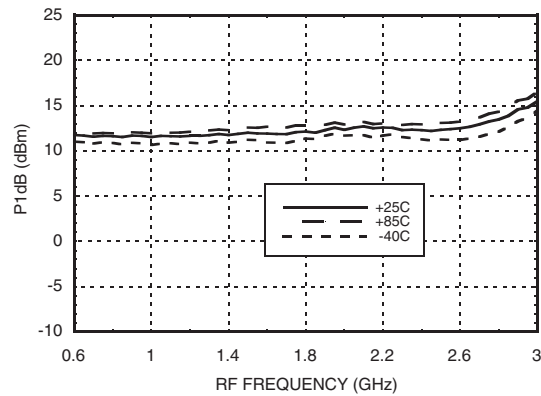

[1] LO < RF  
\* Unless otherwise noted all measurements with R1= 13 Ohms



## SiGe WIDEBAND DOWNCONVERTER, 0.6 - 2.7 GHz

**Input IP3 vs. LO Drive, IF = 100 MHz [1]**

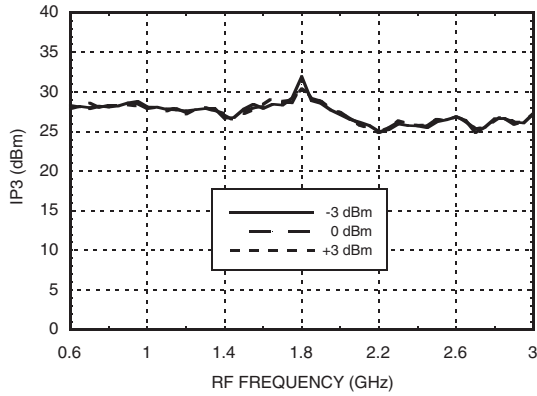

**Input IP3 vs. Temperature  
@ LO = 0 dBm, IF = 100 MHz [1]**

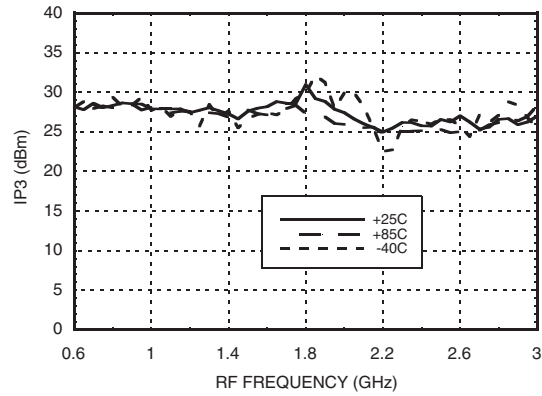

**Input IP3 vs. LO Drive, IF = 240 MHz [1]**

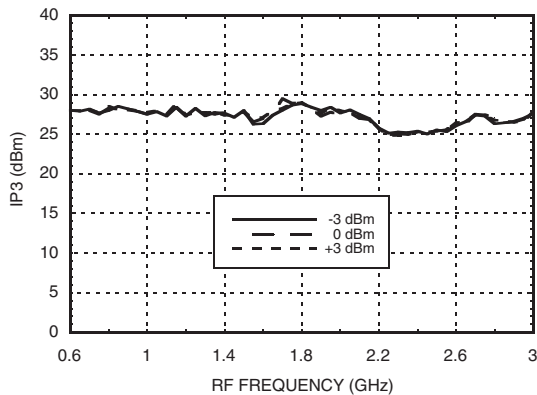

**Input IP3 vs. Temperature  
@ LO = 0 dBm, IF = 240 MHz [1]**

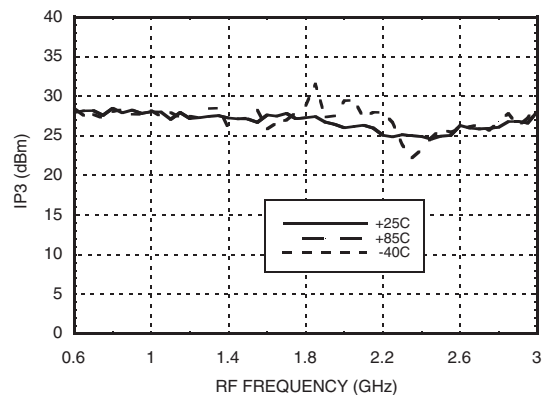

**Noise Figure [1]**

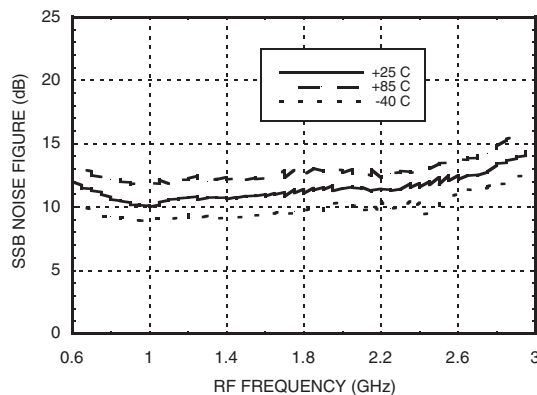

**RF Return Loss @ LO = 0 dBm [1]**

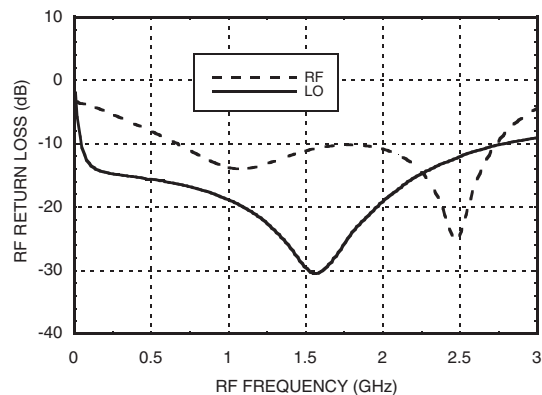

[1] LO < RF

\* Unless otherwise noted all measurements with R1= 13 Ohms

**Isolation @ LO = 0 dBm, IF = 100 MHz [1]**

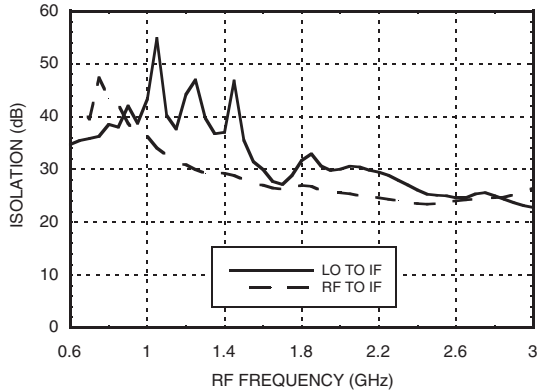

**LO - RF Isolation @ LO = 0 dBm [1]**

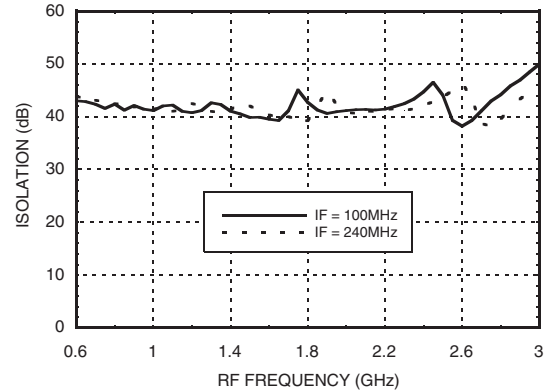

**Conversion Gain vs. Temperature, IF = 184 MHz, USB [2]**

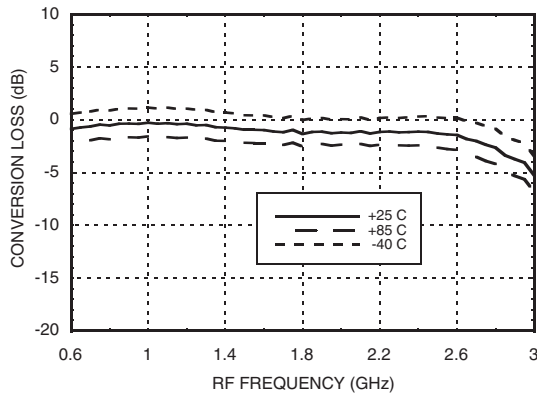

**Noise Figure, IF = 184 MHz, USB [2]**

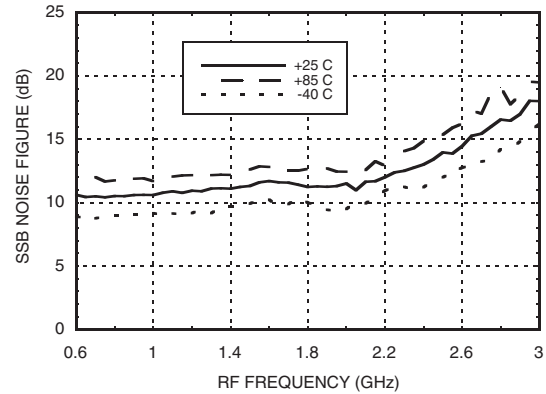

**Input IP3 vs. LO Drive, IF = 184 MHz, USB [2]**

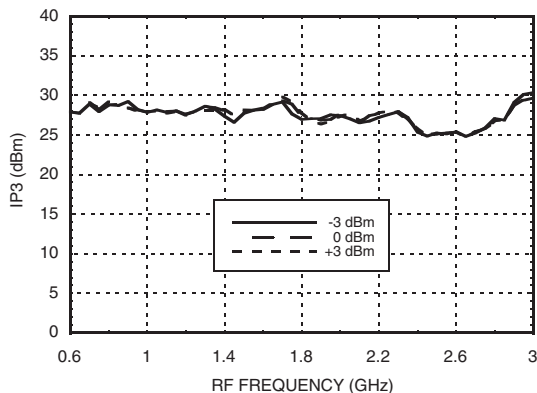

**Input IP3 vs. Temperature @ LO = 0 dBm, IF = 184 MHz, USB [2]**

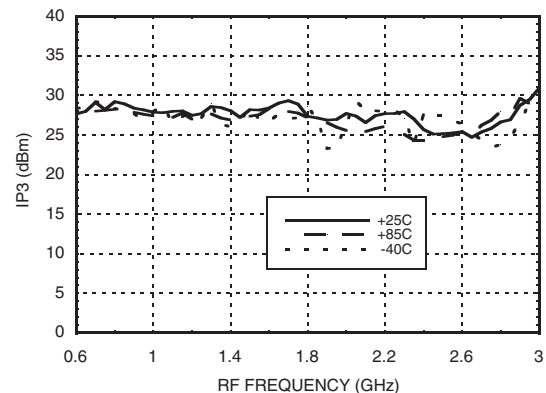

[1] LO < RF  
[2] LO > RF

### Typical Supply Current vs. Supply Voltage

V <sub>SLO</sub> = V <sub>SIF</sub> (V)	I <sub>SLO</sub> + I <sub>SIF</sub> (mA)
+4.5	146
+5.0	173
+5.5	200

Downconverter will operate over full voltage range shown above.



ELECTROSTATIC SENSITIVE DEVICE  
OBSERVE HANDLING PRECAUTIONS

### Absolute Maximum Ratings

RF Input (V <sub>SLO</sub> = V <sub>SIF</sub> = +5V)	+21 dBm
LO Drive (V <sub>SLO</sub> = V <sub>SIF</sub> = +5V)	+12 dBm
V <sub>ccLO</sub> , V <sub>ccIF</sub>	+6 Vdc
Channel Temperature	150 °C
Continuous P <sub>diss</sub> (T = 85°C) (derate 27.8 mW/°C above 85°C)	1.8 W
Thermal Resistance (channel to ground paddle)	36 °C/W
Storage Temperature	-65 to 150 °C
Operating Temperature	-40 to 85 °C

### Outline Drawing

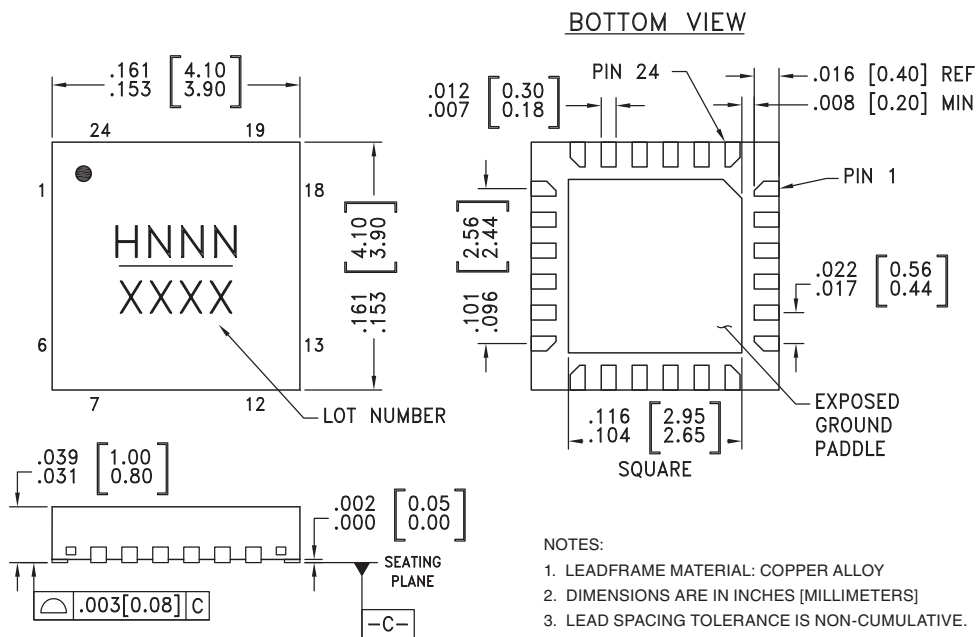

### Package Information

Part Number	Package Body Material	Lead Finish	MSL Rating	Package Marking <sup>[3]</sup>
HMC334LP4	Low Stress Injection Molded Plastic	Sn/Pb Solder	MSL1 <sup>[1]</sup>	H334 XXXX
HMC334LP4E	RoHS-compliant Low Stress Injection Molded Plastic	100% matte Sn	MSL1 <sup>[2]</sup>	H334 XXXX

[1] Max peak reflow temperature of 235 °C

[2] Max peak reflow temperature of 260 °C

[3] 4-Digit lot number XXXX

### Pin Descriptions

Pin Number	Function	Description	Interface Schematic
1	VccLO	Supply for LO Amplifier. Draws approximately 120mA from VSLO. A 13 Ohm resistor (R1) must be connected externally between the VSLO supply and the VccLO pin. See evaluation PCB schematic.	
2, 5, 8, 11, 14, 17, 20, 23	GND	These pins and the ground paddle should be connected to a high quality RF/DC ground.	
3	LOP	LO Input Port. This pin needs a DC blocking capacitor. (Typical voltage on this pin will be 1.5 - 1.8V)	
4	LON	For single ended applications, this pin should be AC grounded	
6, 7, 12, 21, 22, 24	N/C	The pins are not connected internally; however, all data shown herein was measured with these pins connected to RF/DC ground externally.	
9, 10	IFN, IFP	Differential baseband outputs, 200 ohm differential output impedance. Each port should draw approximately 25mA from VSIF without LO power and 28mA from VSIF with LO power on.  For single-ended 50 Ohm operation, port J2 or J3 should be shorted to RF/DC ground. See evaluation PCB schematic.	
13, 18	CTRF	Center tap of the RF transformer. Biased at 2.2V when connected to ground through two 91 ohm resistors.	
15	GNDRF	Pin to be connected to a high quality RF/DC ground. Also can be used to drive the RF port differentially if needed.	
16	RF	50 Ohms impedance can be matched from 600 - 3000 MHz.	
19	VccIF	Supply decoupling for the mixer stage. (Typical voltage on this pin will be 4.8V) Connect C3 to a high quality RF/DC ground per evaluation PCB schematic.	

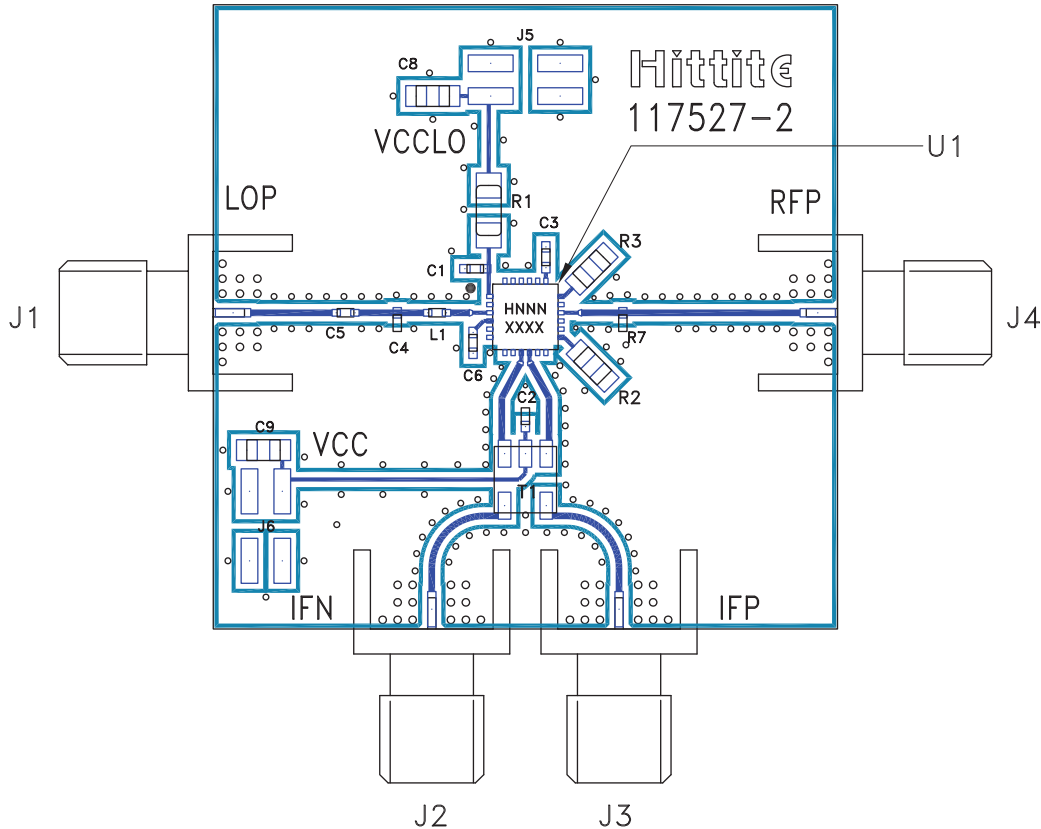
**Evaluation PCB**

**List of Materials for Evaluation PCB 117528 [1]**

Item	Description
J1 - J4	Johnson SMA Connector
J5 - J6	2mm SMT
C1 - C3	1000 pF Capacitor, 0402 Pkg.
C4	0.3 pF Capacitor, 0402 Pkg.
C5	100 pF Capacitor, 0402 Pkg.
C6	10 KpF Capacitor, 0402 Pkg.
C7	1.3 pF Capacitor, 0402 Pkg.
C8, C9	0.1 $\mu$ F Capacitor, 0805 Pkg.
L1	2.7 nH Chip Inductor, 0603 Pkg.
L2	2 nH Chip Inductor, 0603 Pkg.
R1	13 Ohm Resistor, 1206 Pkg.
R2, R3	91 Ohm Resistor, 0805 Pkg.
T1	M/A-Com 4:1 Balun, MABAES0061
U1	HMC334LP4 / HMC334LP4E
PCB [2]	117527 Evaluation Board

[1] Reference this number when ordering complete evaluation PCB

[2] Circuit Board Material: Rogers 4350

The circuit board used in the final application should use RF circuit design techniques. Signal lines should have 50 Ohm impedance while the package ground leads and exposed paddle should be connected directly to the ground plane similar to that shown. A sufficient number of via holes should be used to connect the top and bottom ground planes. The evaluation circuit board shown is available from Hittite upon request.

### Evaluation PCB Schematic

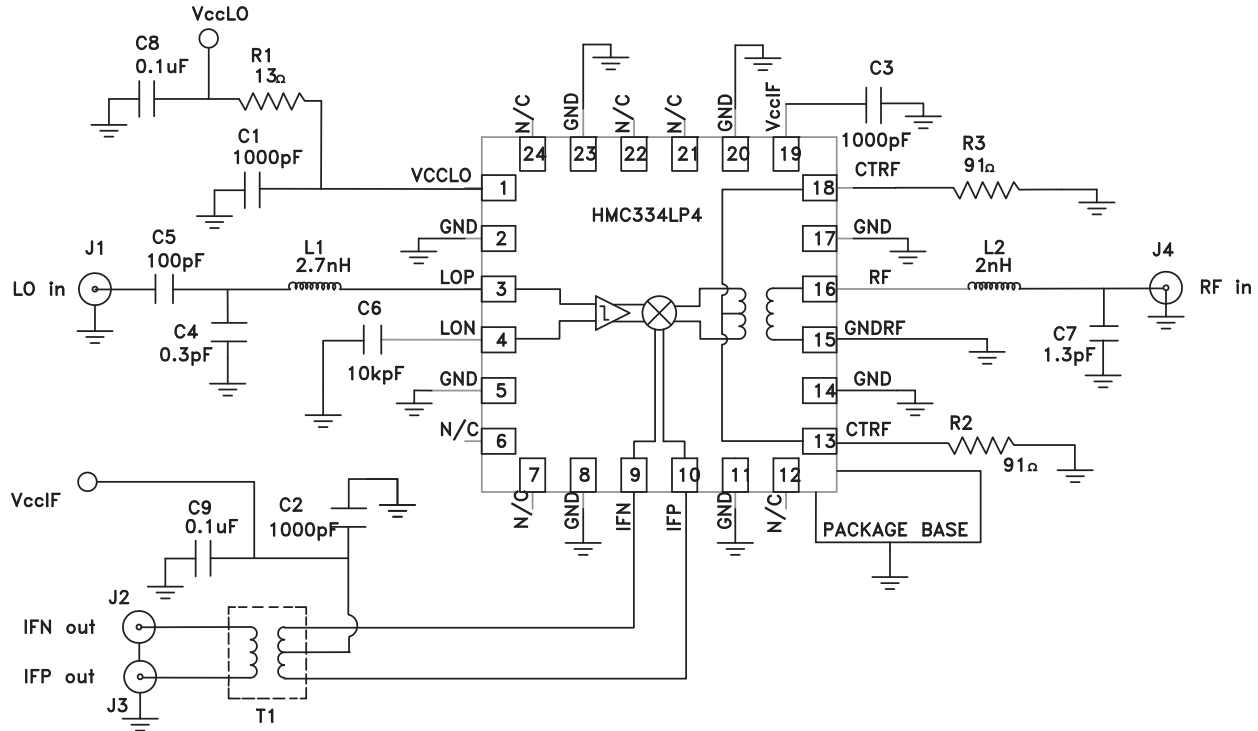

Note: For single-ended 50 Ohms operation, port J2 or J3 should be shorted to RF/DC ground.