

SF2220C

193.60 MHz SAW Filter

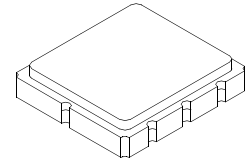

SM5050-8

- **Low Insertion Loss**
- **Excellent Size-to-performance Ratio**
- **Hermetic SM5050-8 Surface-mount Case**
- **Single-ended Input and Output**
- **Complies with Directive 2002/95/EC (RoHS)**



Absolute Maximum Ratings

Rating	Value	Units
Maximum Incident Power in Passband	+18	dBm
Maximum DC Voltage on any Non-ground Terminal	30	VDC
Storage Temperature Range in Tape and Reel	-40 to +85	°C
Suitable for Lead-free Soldering - Maximum Soldering Profile	260 °C for 30 s	

Electrical Specifications

Characteristic	Sym	Notes	Min	Typ	Max	Units
Nominal Center Frequency	f_c		193.60			MHz
Passband:		1				
Minimum Insertion Loss				5.3	7.0	dB
3 dB Bandwidth	BW_3		110	150		kHz
Amplitude Ripple, 193.56 to 193.64 MHz		1, 2		0.5	1.0	dB _{P-P}
Group Delay Variation, 193.545 to 193.655 MHz	GDV			1900	2500	ns _{P-P}
Absolute Delay at 193.6 MHz	AGD		4500	5000	5500	ns
Rejection:						
30 dB Low Side Rejection Frequency		1, 2, 3	193.350	193.390		MHz
30 dB High Side Rejection Frequency				193.800	193.850	
Ultimate Rejection, <192.2 MHz, >195.0 MHz			45	52		dB
Operating Temperature Range	T_A	1	0		+70	°C

Impedance Matching to 50 Ω Single-ended Source and Load	External L-C
Case Style	SM5050-8, 5 x 5 mm Nominal Footprint
Lid Symbolization (Y = year, WW = week, S = shift)	957, YWWS



CAUTION: Electrostatic Sensitive Device. Observe precautions for handling.

NOTES:

1. Unless noted otherwise, all specifications apply over the operating temperature range with filter soldered to the specified demonstration board with impedance matching to 50 Ω and measured with 50 Ω network analyzer.
2. Unless noted otherwise, all frequency specifications are referenced to the nominal center frequency, f_c .
3. Rejection is measured as attenuation below the minimum IL point in the passband. Rejection in final user application is dependent on PCB layout and external impedance matching design. See Application Note No. 42 for details.
4. The turnover temperature, T_o , is the temperature of maximum (or turnover) frequency, f_o . The nominal frequency at any case temperature, T_c , may be calculated from: $f = f_o [1 - FTC(T_o - T_c)^2]$.
5. The design, manufacturing process, and specifications of this filter are subject to change.
6. Either Port 1 or Port 2 may be used for either input or output in the design. However, impedances and impedance matching may vary between Port 1 and Port 2, so that the filter must always be installed in one direction per the circuit design.
7. US and international patents may apply.

Frequency Response Plots

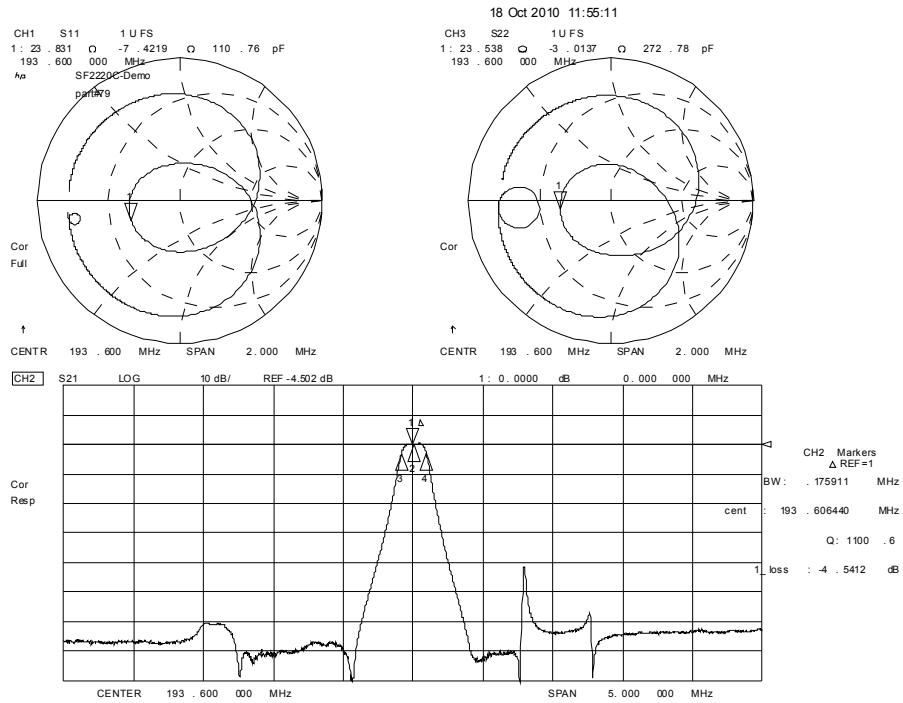

SF2220C Test Circuit

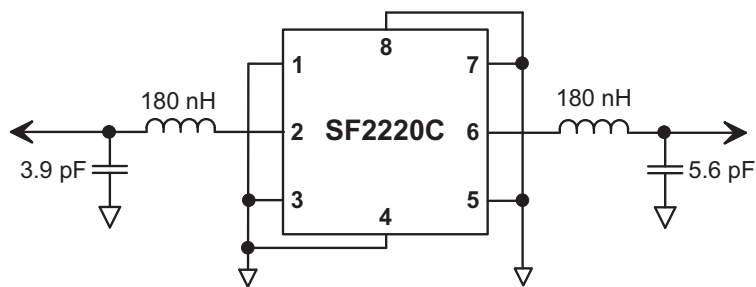

SM5050-8 Surface-Mount 8-Terminal Ceramic Case 5.0 X 5.0 mm Nominal Footprint

Case Dimensions

Dimension	mm			Inches		
	Min	Nom	Max	Min	Nom	Max
A	4.80	5.00	5.20	0.189	0.197	0.205
B	4.80	5.00	5.20	0.189	0.197	0.205
C	1.30	1.50	1.70	0.050	0.060	0.067
D	1.98	2.08	2.18	0.078	0.082	0.086
E	1.07	1.17	1.27	0.042	0.046	0.050
F	0.50	0.64	0.70	0.020	0.025	0.028
G	2.39	2.54	2.69	0.094	0.100	0.106
H		1.27			0.050	
I		0.76			0.030	
J		1.55			0.061	
K		2.79			0.110	
L		0.76			0.030	
M		2.36			0.093	
N		1.55			0.061	
O		2.79			0.110	
P		2.79			0.110	
Q		2.79			0.110	

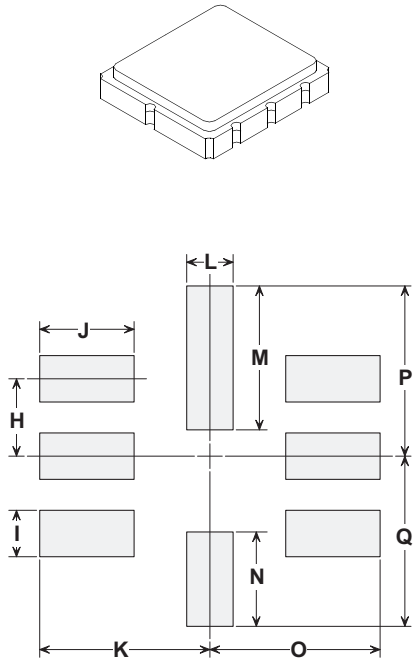

PCB Footprint

Case Materials

Materials	
Solder Pad Plating	0.3 to 1.0 μm Gold over 1.27 to 8.89 μm Nickel
Lid Plating	2.0 to 3.0 μm Nickel
Body	Al_2O_3 Ceramic
	Pb Free

Electrical Connections

Connection		Terminals
Port 1	Input	2
Port 2	Output	6
	Ground	All others

Dot indicates Pin 1

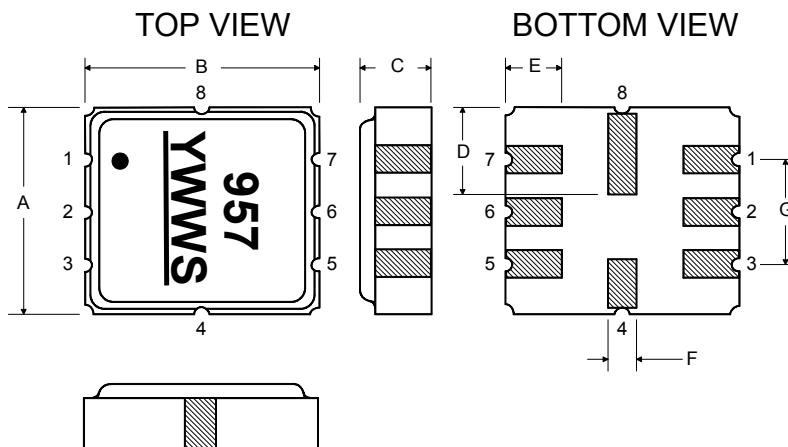

Tape and Reel Specifications

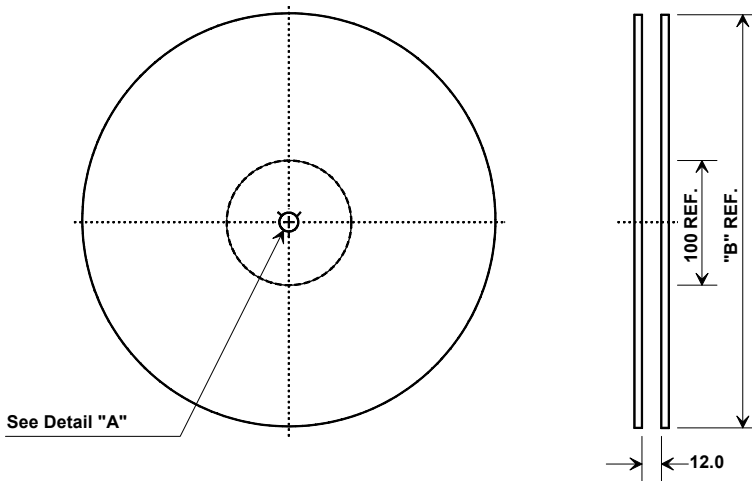

"B" Nominal Size		Quantity Per Reel
Inches	millimeters	
7	178	500
13	330	3000

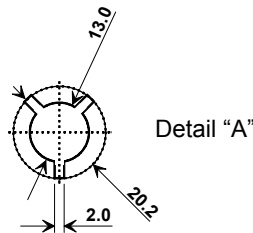

COMPONENT ORIENTATION and DIMENSIONS

Carrier Tape Dimensions	
Ao	5.3 mm
Bo	5.3 mm
Ko	2.0 mm
Pitch	8.0 mm
W	12.0 mm

