

REVISIONS				
REV	DESCRIPTION	DATE	BY	ECO

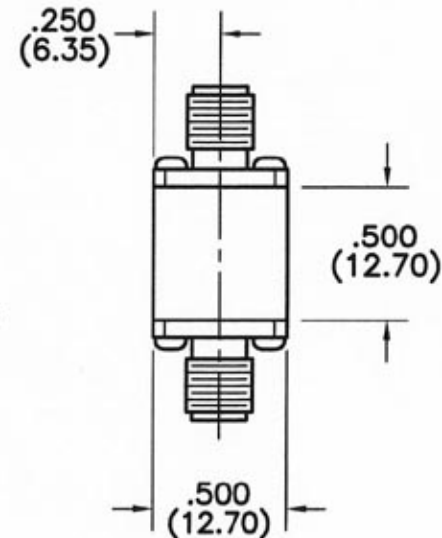

SPECIFICATIONS

FREQUENCY RANGE: 18.0-26.5 GHz
 INSERTION LOSS: 1.4dB
 ISOLATION: 18dB
 VSWR: 1.60:1
 INPUT POWER: 30 WATTS AVG.
 IMPEDANCE: 50 OHMS

DIMENSIONS: INCHES (MILLIMETERS)

TOLERANCES	
DEC.XX ± .03	FRAC ±
.XXX ± .010	ANG ±
MATERIAL	
FINISH	
DIMENSIONS ARE IN INCHES UNLESS OTHERWISE SPECIFIED.	

THE INFORMATION CONTAINED IN THIS DOCUMENT IS THE PROPERTY OF MICROWAVE DEVICES, INC. AND IS PROPRIETARY. IT IS NOT TO BE COPIED OR USED FOR ANY PURPOSE OTHER THAN AS INSTRUCTED, IN WRITING, BY MICROWAVE DEVICES, INC.

SIGNATURES		DATE
DR	G.V.Cothren	11-9-06
CHK		
APPD		
APPD		

MICROWAVE DEVICES
 RF and Microwave Components

**OUTLINE, MODEL 2PD22.25-2
 2 WAY DIVIDER/COMBINER**

CAGE	SIZE	DRAWING NO.
60674	A	900254-1
DRAWING SCALE		SHEET 1 OF 1
1.5:1		