

Features

- For wireless applications
- Usable bandwidth 60 MHz
- High attenuation
- No impedance matching required for operation at 50 Ω
- Single-ended operation
- Ceramic Surface Mount Package (SMP)
- Hermetic
- RoHS compliant (2002/95/EC), Pb-free 

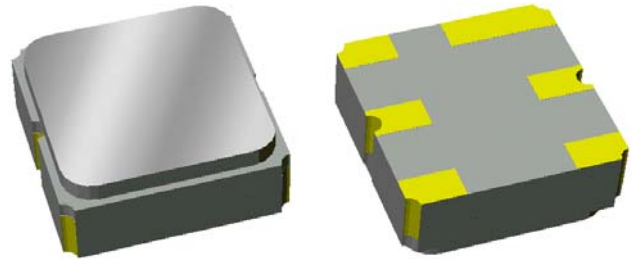

Package

Surface Mount 3.00 x 3.00 x 1.22 mm

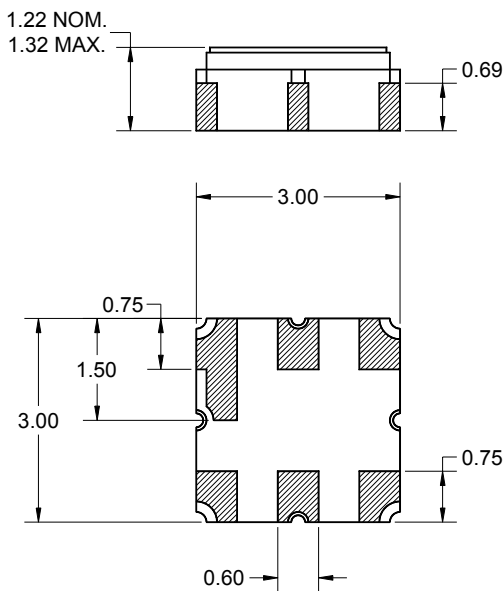

Pin Configuration

Bottom View

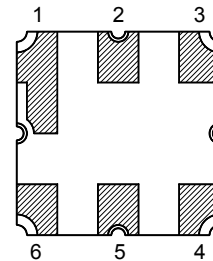

| Pin No. | Description |
|---------|-------------|
| 2 | Input |
| 5 | Output |
| 1,3,4,6 | Case ground |

Dimensions shown are nominal in millimeters
All tolerances are ±0.15mm except overall length and width ±0.10mm

Body: Al_2O_3 ceramic
Lid: Kovar, Ni plated
Terminations: Au plating 0.5 - 1.0μm, over a 2 - 6μm Ni plating

Electrical Specifications ⁽¹⁾

Operating Temperature Range: ⁽²⁾ -20 to +75 °C

| Parameter ⁽³⁾ | Minimum | Typical | Maximum | Unit |
|--|---------|---------|---------|--------|
| Center Frequency | - | 1960 | - | MHz |
| Maximum Insertion Loss 1930 - 1990 MHz | - | 2.25 | 5 | dB |
| Amplitude Variation 1930 - 1990 MHz | - | 0.95 | 2.75 | dB p-p |
| Absolute Attenuation 500 - 1700 MHz | 18 | 19.7 | - | dB |
| 1700 - 1850 MHz | 20 | 21.4 | - | dB |
| 1850 - 1910 MHz | 14 | 16 | - | dB |
| 2020 - 2040 MHz | 10 | 20.7 | - | dB |
| 2040 - 2100 MHz | 18 | 23 | - | dB |
| 2100 - 5000 MHz | 19 | 21.7 | - | dB |
| Source Impedance ⁽⁴⁾ | - | 50 | - | Ω |
| Load Impedance ⁽⁴⁾ | - | 50 | - | Ω |

Notes:

1. All specifications are based on TriQuint test circuit shown below
2. In production, devices will be tested at room temperature to a guardbanded specification to ensure electrical compliance over temperature
3. Electrical margin has been built into the design to account for the variations due to temperature drift and manufacturing tolerances
4. This is the optimum impedance in order to achieve the performance shown

Test Circuit:

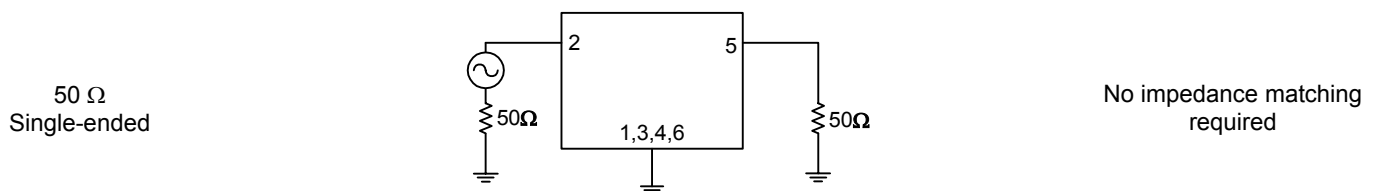

Typical Performance (at +25°C)

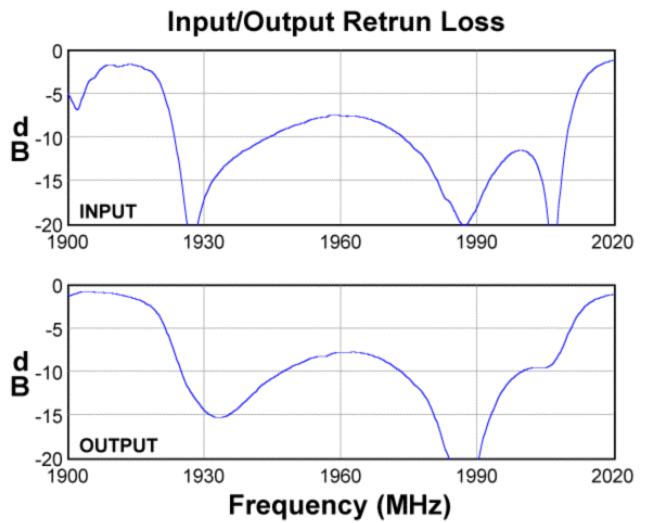
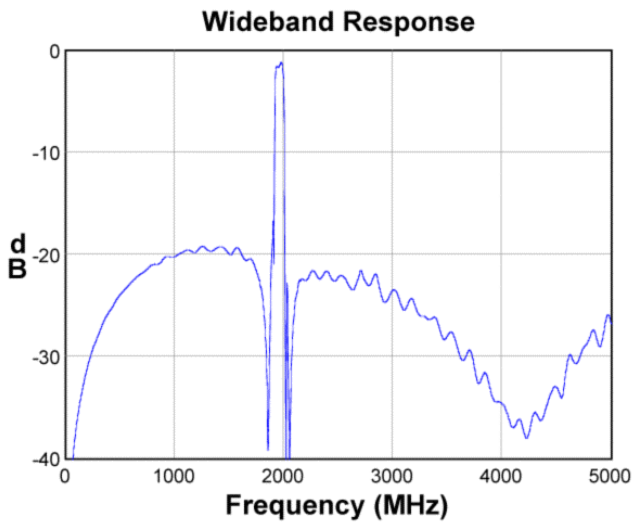
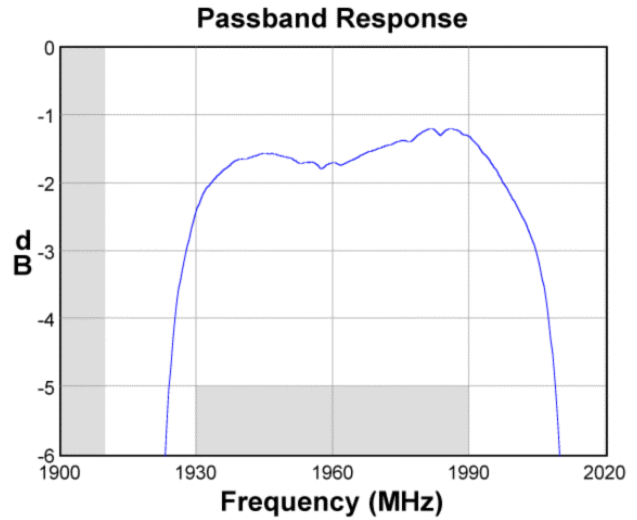
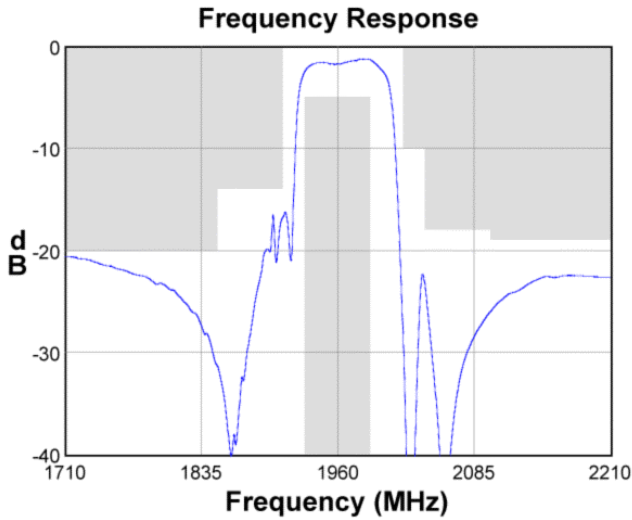

Input Smith Chart

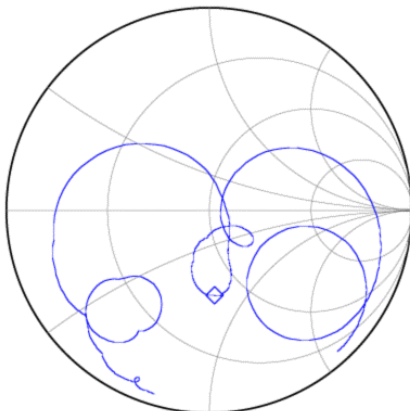

Output Smith Chart

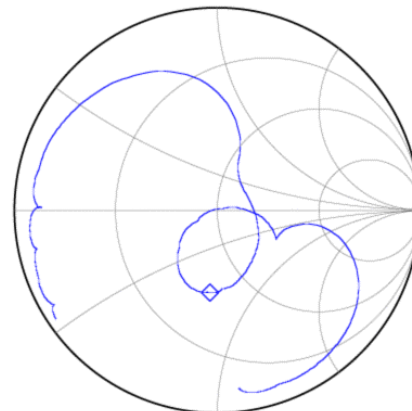

Matching Schematics

50 Ω
Single-ended

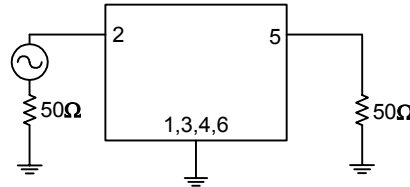

No impedance matching required

Marking

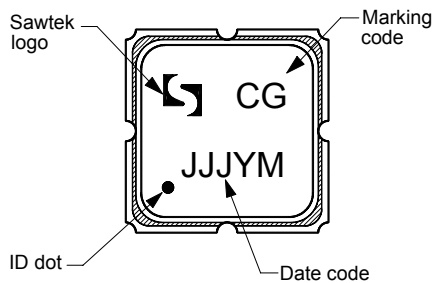

The date code consists of: JJJ = Julian day,
Y = last digit of year, M = manufacturing site code

PCB Footprint

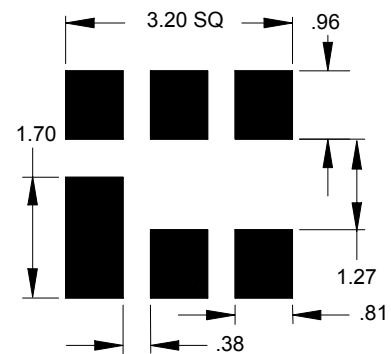

This footprint represents a recommendation only
Dimensions shown are nominal in millimeters

Tape and Reel

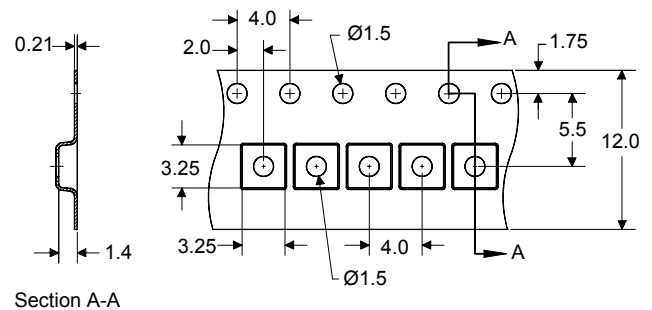
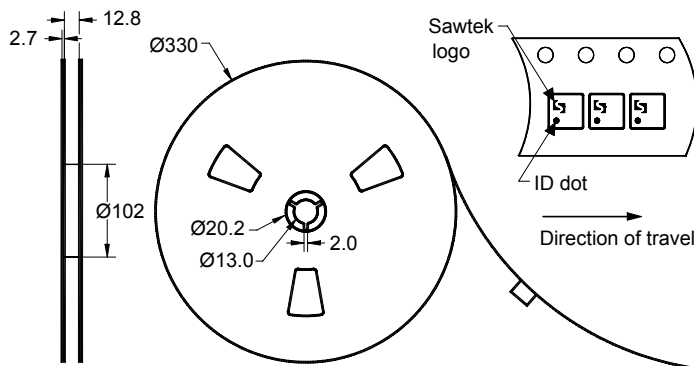

Dimensions shown are nominal in millimeters
Packaging quantity: 5000 units/reel

Maximum Ratings

| Parameter | Symbol | Minimum | Maximum | Unit |
|-----------------------------|------------------|---------|---------|------|
| Operating Temperature Range | T | -20 | +75 | °C |
| Storage Temperature Range | T _{stg} | -40 | +85 | °C |

Important Notes

Warnings

- Electrostatic Sensitive Device (ESD) 
- Avoid ultrasonic exposure

RoHS Compliance

- This product complies with EU directive 2002/95/EC (RoHS) 

Solderability

- Compatible with JEDEC J-STD-020C **Pb**-free process, **260°C** peak reflow temperature ([see soldering profile](#))

Links to Additional Technical Information

[PCB Layout Tips](#)

[Qualification Flowchart](#)

[Soldering Profile](#)

[S-Parameters](#)

[RoHS Information](#)

[Other Technical Information](#)

TriQuint's liability is limited only to the Surface Acoustic Wave (SAW) component(s) described in this data sheet. TriQuint does not accept any liability for applications, processes, circuits or assemblies, which are implemented using any TriQuint component described in this data sheet.

Contact Information



PO Box 609501
Orlando, FL 32860-9501
USA

Phone: +1 (407) 886-8860
Fax: +1 (407) 886-7061
Email: info-product@tqs.com
Web: www.triquint.com

Or contact one of our worldwide
Network of [sales offices](#),
[Representatives or distributors](#)