

RoHS Compliant

CATV Diplex Filter
5 - 30 / 46 - 870MHz

MAFLCT0066
V3

Features

- 75 Ohm
- SMT unit
- Excellent temperature stability
- Excellent repeatability
- Lead Free

Description

M/A-COM's MAFLCT0066 is a low cost, surface mount diplex filter unit designed for CATV FTTx, Home Gateway and Distribution applications.

Functional Schematic

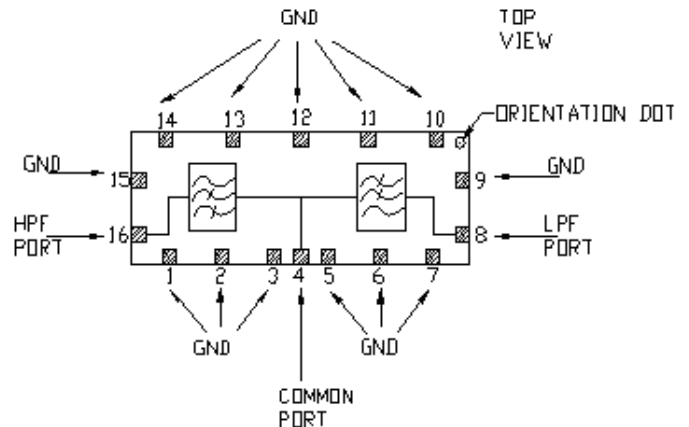

Pin Configuration

Function	Pin Number
Common Port	4
Low Pass Port	8
High Pass Port	16
Ground	1-3, 5-7, 10-15
Not connected	-

Absolute Maximum Ratings ^{1,2}

Parameter	Absolute Maximum
RF Power	250mW
DC Current	30mA
Operating Temperature	-40°C to +85°C
Storage Temperature	-40°C to +85°C

1. Exceeding any one or combination of these limits may cause permanent damage to this device.
2. M/A-COM does not recommend sustained operation near these survivability limits.

* Restrictions on Hazardous Substances, European Union Directive 2002/95/EC.

CATV Diplex Filter
5 - 30 / 46 - 870MHz

MAFLCT0066
V3

SM-160 Case Style

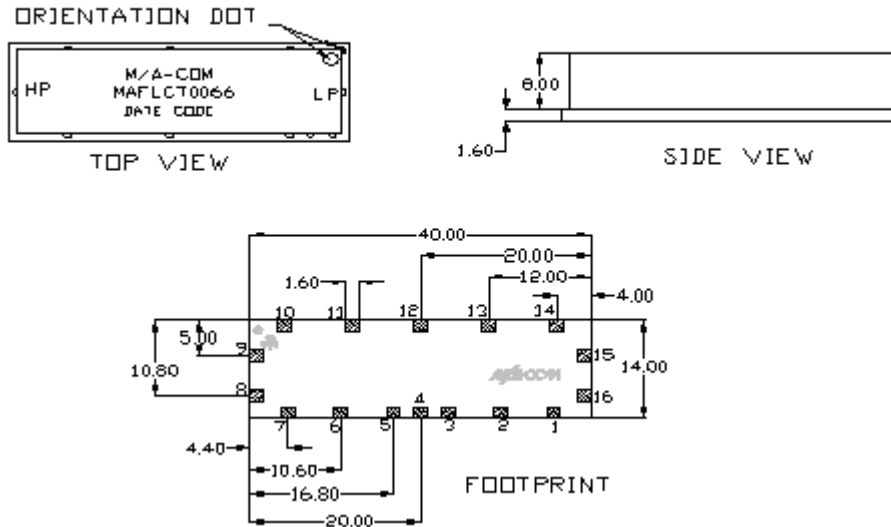

Dimensions in mm. Tolerance: .xx ± 0.02, .xxx ± 0.010

Recommended PCB Configuration

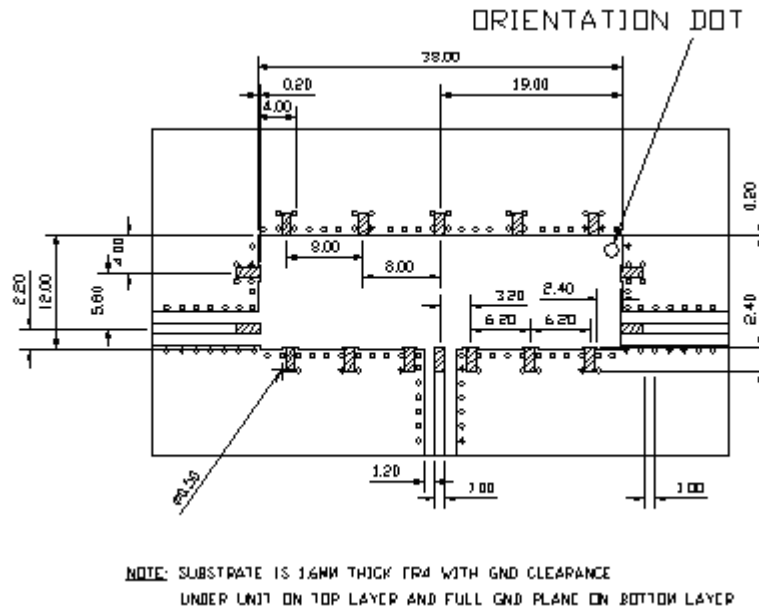

Dimensions in mm. Tolerance: .xx ± 0.02, .xxx ± 0.010

CATV Diplex Filter
5 - 30 / 46 - 870MHz

MAFLCT0066
V3

Electrical Specifications: $T_A = 25^\circ\text{C}$, $Z_0 = 75\Omega$

Parameter	Test Conditions	Units	Min	Typ	Max
Frequency Range	5 - 30MHz / 46 - 870MHz				
Insertion Loss	5 - 30MHz	dB		-0.7	-0.9
Insertion Loss	46 - 870MHz	dB		-0.75	-0.9
Isolation	5 - 30MHz	dB	-45	-47	
Isolation	31 - 45MHz	dB	-15	-20	
Isolation	46 - 870MHz	dB	-45	-46	
Input Return Loss	5 - 30MHz	dB	-17	-18	
Input Return Loss	46 - 870MHz	dB	-20	-20	

Additional Specifications	Group Delay (nSec)	
	TYP	MAX
28.5 – 30MHz	5ns	10ns
46 – 47.5MHz	10ns	15ns
55.25 – 58.83MHz	5ns	10ns
61.25 – 64.83MHz	5ns	10ns

CATV Diplex Filter
5 - 30 / 46 - 870MHz

MAFLCT0066
V3

Typical Performance Curves

Low Pass Filter Insertion Loss

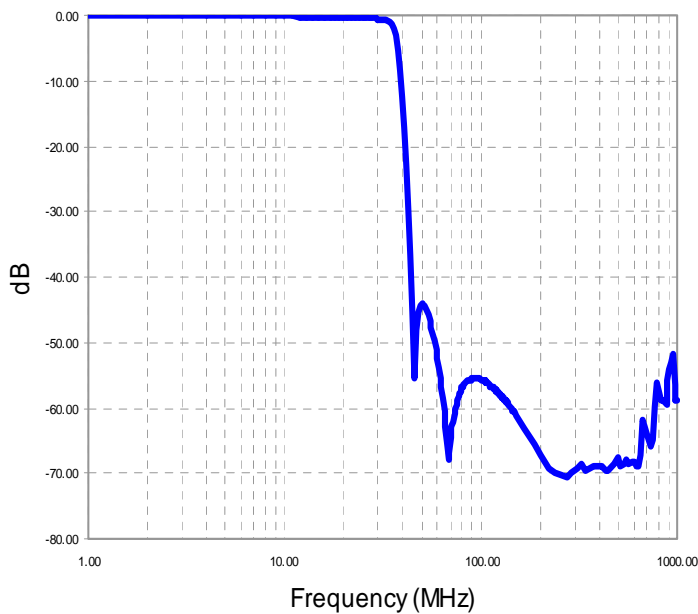

High Pass Filter Insertion Loss

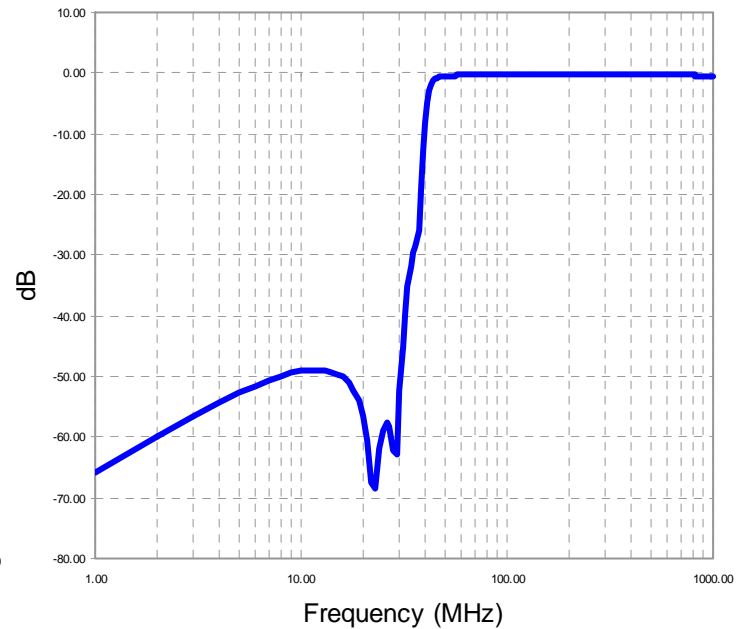

Input Return Loss

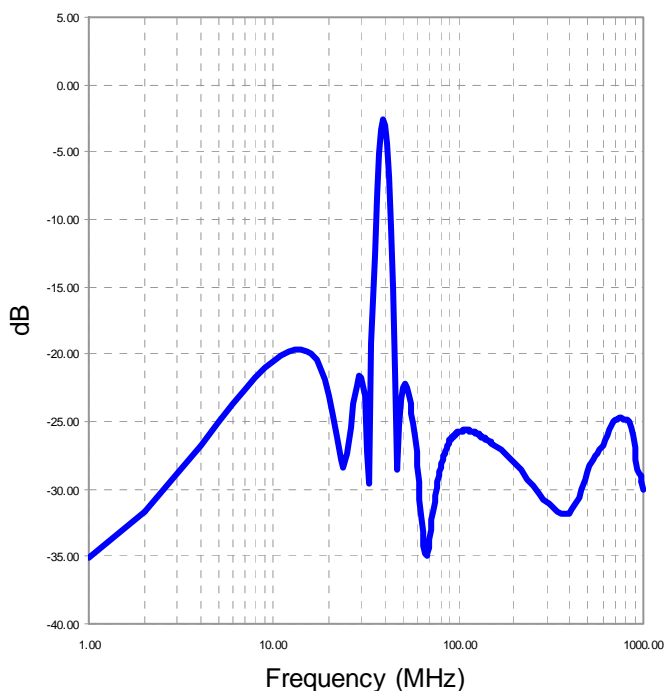

Isolation

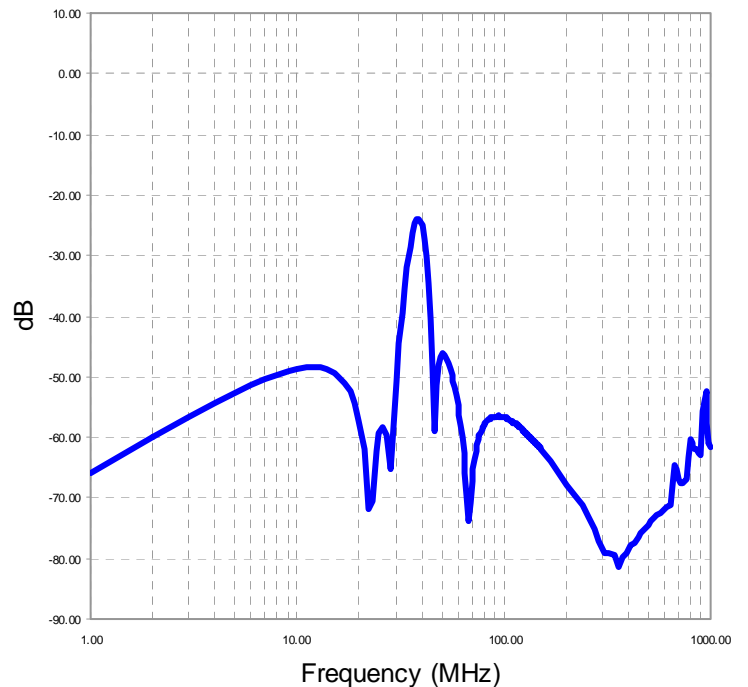

ADVANCED: Data Sheets contain information regarding a product M/A-COM Technology Solutions is considering for development. Performance is based on target specifications, simulated results, and/or prototype measurements. Commitment to develop is not guaranteed.

PRELIMINARY: Data Sheets contain information regarding a product M/A-COM Technology Solutions has under development. Performance is based on engineering tests. Specifications are typical. Mechanical outline has been fixed. Engineering samples and/or test data may be available. Commitment to produce in volume is not guaranteed.

• **North America** Tel: 800.366.2266 • **Europe** Tel: +353.21.244.6400
• **India** Tel: +91.80.4155721 • **China** Tel: +86.21.2407.1588
Visit www.macomtech.com for additional data sheets and product information.

M/A-COM Technology Solutions Inc. and its affiliates reserve the right to make changes to the product(s) or information contained herein without notice.